

Proceedings of the Eighth
EuroGOOS International Conference

3-5 October 2017, Bergen, Norway



OPERATIONAL OCEANOGRAPHY

Serving Sustainable Marine Development



EuroGOOS
European Global Ocean
Observing System

www.eurogoos.eu

Proceedings of the Eighth
EuroGOOS International Conference

3-5 October 2017, Bergen, Norway



OPERATIONAL OCEANOGRAPHY

Serving Sustainable Marine Development

Edited by:

Edited by: Erik Buch, Vicente Fernández, Dina Eparkhina,
Patrick Gorringe and Glenn Nolan

Published by:

EuroGOOS AISBL

231 Avenue Louise

1050 Brussels

Belgium

www.eurogoos.eu

To be quoted as follows:

Operational Oceanography serving Sustainable Marine Development.

Proceedings of the Eight EuroGOOS International Conference.

3-5 October 2017, Bergen, Norway.

E. Buch, V. Fernández, D. Eparkhina, P. Gorringer and G. Nolan (Eds.)

EuroGOOS. Brussels, Belgium. 2018.

D / 2018 / 14.040 / 1

ISBN 978-2-9601883-3-2. 516 pp.



CONFERENCE ORGANISERS

Scientific Steering Committee

Erik Buch	EuroGOOS Chair
Glenn Nolan	EuroGOOS Secretary General
Enrique Álvarez Fanjul	MONGOOS, Puertos del Estado, Spain
Bernd Brüggge	BSH, Germany
Patrick Farcy	IFREMER, France
Vicente Fernández	EuroGOOS Science Officer
Patrick Gorringer	EuroGOOS Senior Operations Officer
Sebastien Legrand	RBINS, Belgium
Urmas Lips	BOOS, TTU, Estonia
Julien Mader	AZTI, Spain
Antonio Martinho	IH, Portugal
George Petihakis	HCMR, Greece
Manuel Ruiz Villarreal	IEO, Spain
Stein Sandven	Arctic ROOS, NERSC, Norway
Rosalia Santoleri	CNR, Italy
Jun She	DMI, Denmark
Henning Wehde	NOOS, IMR, Norway

Organising Committee

IMR and NERSC, Norway, and EuroGOOS Office

TABLE OF CONTENTS

Statements from the Conference	13
Ocean Observations: Observing networks and sensors	17
The strategy for evolution of Argo in Europe	19
<i>C. Gourcuff, J. Buck, R. Cancouët, H. Claustre, J. Haapala, H. Heinrich, D. Kassis, B. A. King, B. Klein, G. Korres, G. Maze, K. A. Mork, G. Obolensky, D. O’Conchubhair, E. O’Rourke, P. M. Poulain, S. Pouliquen, A. Sterl, V. Thierry, P. Vélez and W. Walczowski</i>	
Towards an integrated EU data system within AtlantOS	27
<i>S. Pouliquen, V. Harscoat and AtlantOS WP7 partners</i>	
JERICO-RI: The integrated coastal component of the European Ocean Observing System	35
<i>P. Farcy, D. Durand, I. Puillat, G. Petihakis and J. Tintoré</i>	
Deployment of new observing systems within the JERICO-RI	43
<i>I. Puillat, A. Carlier, J.V. Facq, A. Rubio, P. Lazure, L. Delauney, G. Petihakis, B. Karlson, F. Artigas and P. Farcy</i>	
The POSEIDON system, an integrated observing infrastructure at the Eastern Mediterranean as a contribution to the European Ocean Observing System	53
<i>L. Perivoliotis, G. Petihakis, M. Korres, D. Ballas, C. Frangoulis, P. Pagonis, M. Ntoumas, M. Pettas, A. Chalkiopoulos, M. Sotiropoulou, M. Bekiari, A. Kalampokis, M. Ravdas, E. Bourma, S. Christodoulaki, A. Zacharioudaki, D. Kassis, M. Potiris, G. Triantafyllou, A. Papadopoulos, K. Tsiaras and S. Velanas</i>	
FerryBoxes within Europe: State-of-the-art and Integration in the European Ocean Observation System (EOOS)	63
<i>W. Petersen, F. Colijn, P. Goringe, S. Kaitala, B. Karlson, A. King, U. Lips, M. Ntoumas, J. Seppälä, K. Sørensen, G. Petihakis, L.P. De La Villéon and H. Wehde</i>	
CMEMS Present and Future Requirements for Satellite and In situ Observations	71
<i>A. Reppucci and P. Y. Le Traon</i>	
Assessment of Baltic Sea observations for operational oceanography	79
<i>J. She</i>	
New Sources of in situ Marine Data to Support EC Marine Strategy Framework Directive Implementation in the Black Sea	89
<i>A. Palazov, V. Slabakova and V. Marinova</i>	
Novel, multi-platform acoustic and optical sensors and data services developed in the NeXOS project	97
<i>L. Golmen, E. Delory, O. Zielinski, J. del Rio, K. Kvalsund, J. Pearlman, L. de Swart, L. Delauney, M. Rieke and S. Østerhus</i>	
Acoustic tomography as a component the Atlantic Ocean Observing System: Opportunities and Challenges	105
<i>B. Dushaw</i>	
New acoustic profiling instrumentation with optode measurements of pCO₂ and pH tested in the Southern Adriatic	113
<i>V. Cardin, A. Tengberg, M. Bensi, E. Dorgeville, M. Giani, G. Siena, F. Brunetti, L. Ursella, S. Kuchler, A. Bubbi, P. Mansutti and F. Arena</i>	

Current and emerging in situ biogeochemical observations using the FerryBox platform in Subarctic and Arctic Norwegian waters <i>A.L. King, M. Norli, A.B. Ledang, P. Jaccard, E. Reggiani, S. Marty, R.G.J. Bellerby, L. Golmen and K. Sørensen</i>	121
Novel biogeochemical sensors: Operation of a newly developed total alkalinity (TA) analyser in combination with a FerryBox for better quantification of the carbon dynamics in the North Sea <i>Y.G. Voynova, W. Petersen, M. Gehrung and S. Assmann</i>	127
GlobCurrent: A Pre-operational monitoring system for surface current and upper ocean dynamics based on sensor synergy <i>J.A. Johannessen, B. Chapron, F. Collard, M.-H. Rio, J.-F. Piollé, L. Gaultier, G. Quartly, J. Shutler, R. Escola, R. P. Raj, C. Donlon, R. Danielson, A. Korosov, F. Nencioli, M. Roca and M. Hansen</i>	135
Euro-Argo in work and new potential of gliders in the Baltic Sea BOOS <i>P. Alenius, K. Tikka, U. Lips, L. Tuom, T. Purokoski, P. Roiha and S. Siiriä</i>	143
Cross-shelf exchanges in the Bay of Biscay <i>A. Akpınar, G. Charria, F. Vandermeirsch and T. Szekely</i>	149
Operational Wave Height Monitoring Using Navigation Buoys and Marine Radars in the Baltic Sea <i>T. Köuts, S. Rikka, L. Käärman and A. Usk</i>	157
A long-term strategy for monitoring the salt water inflows in the southern Baltic Sea <i>W. Walczowski, P. Wieczorek, I. Goszczko, M. Merchel, D. Rak, A. Beszczynska-Möller and M. Cisek</i>	165
Operational in situ oil spill detection in the Baltic Sea, using FerryBox system equipped with oil sensor <i>T. Köuts, S. Pärt and K. Vahter</i>	169
Multiscale and multidisciplinary Marine Rapid Environmental Assessment data collection methodology for operational and forecasting oceanography <i>I. Federico, F. Maicu, N. Pinardi, P. Oddo, M. Zavatarelli, V. Lyubartsev, S. Causio, C. Caporale, M. Demarte, A. Falconieri, R. Lecci, T. Lacava, M. Lisi, A. Sepp-Neves, G. Lorenzetti, G. Manfe', F. Trotta, L. Zaggia, S. A. Ciliberti, C. Fratianni and A. Grandi</i>	173
Operative met-ocean measurements - challenges and options <i>D. Klarić and D. Rašić</i>	179
A new AERONET-OC site for the northern North Sea <i>R.M. Forster, V. Créach and C. Soraghan</i>	183
A new database of quality-controlled phytoplankton pigments for the European north-west shelf <i>K. Collingridge, R. Forster, E. Capuzzo, L. Schluter, T. Hull and V. Créach</i>	189
Effective vertical mixing over a deep basin via the use of an ARGO float <i>N. Krauzig, V. Zervakis, E. Tragou and E. Krasakopoulou</i>	193

Processes, Modelling and Forecast	199
The Arctic Marine Forecasting Centre of the Copernicus Marine Services	201
<i>L. Bertino, A. Ali, A. Carrasco, A. Melsom, M. Müller, A. Samuelsen, G. Sutherland, T. D. Williams and J. Xie</i>	
Relocatable ocean modelling for downscaling to the shelf and coastal areas	209
<i>F. Trotta, N. Pinardi, S. Masina, G. Coppini, D. Iovino, S. A. Ciliberti, R. Lecci, A. Storto, A. Cipollone, F. Montagna, S. Creti, F. Palermo, G. Turrisi, L. Stefanizzi and M. Francesca</i>	
Performance and quality assessment of the global ocean eddy-permitting physical reanalysis GLORYS2V4	215
<i>G. Garric, L. Parent, E. Greiner, M. Drévillon, M. Hamon, JM Lellouche, C. Régnier, C. Desportes, O. Le Galloudec, C. Bricaud, Y. Drillet, F. Hernandez, C. Dubois and P-Y. Le Traon</i>	
A North Sea-Baltic Sea regional coupled models: Atmosphere, wind waves and ocean	223
<i>J. Staneva, C. Schrum, A. Behrens, S. Grayek, H. Ho-Hagemann, V. Alari, Ø. Breivik and J-R. Bidlot</i>	
Towards seamless ocean modelling for the Baltic Sea	233
<i>J. She and J. Murawski</i>	
A two way nested high resolution coastal simulation in a tidally dominated area: Preliminary results	243
<i>I. Mamoutos, T. Dabrowski, K. Lyons and G. McCoy</i>	
Performance and quality assessment of the current Copernicus Marine Service global ocean monitoring and forecasting real-time system	251
<i>J.-M. Lellouche, O. Le Galloudec, E. Greiner, G. Garric, C. Régnier, M. Clavier, M. Drévillon, F. Gasparin and Y. Drillet</i>	
Overview of CMEMS BAL MFC Service and Developments	261
<i>L. Tuomi, J. She, I. Lorkowski, L. Axell, P. Lagema, F. Schwichtenberg and V. Huess</i>	
CMEMS Baltic Monitoring and Forecasting Centre: High-resolution wave forecasts in the seasonally ice-covered Baltic Sea	269
<i>L. Tuomi, O. Vähä-Piikkiö, T. Siili and V. Alari</i>	
A 1/24° resolution Mediterranean physical analysis and forecasting system for the Copernicus Marine Environment Monitoring Service	275
<i>E. Clementi, J. Pistoia, D. Delrosso, G. Mattia, C. Fratianni, A. Storto S. Ciliberti, B. Lemieux, E. Fenu, S. Simoncelli, M. Drudi, A. Grandi, D. Padeletti, P. Di Pietro and N. Pinardi</i>	
High resolution operational analysis and forecasts for the Mediterranean Sea biogeochemistry	285
<i>S. Salon, G. Cossarini, P. Lazzari, A. Teruzzi, P. Di Cerbo, G. Bolzon, L. Feudale, C. Solidoro and A. Crise</i>	
Modeling in the Mediterranean Sea: the MonGOOS contribution	295
<i>G. Umgiesser, P. Garreau, A. S. Arcilla, E. Clementi, S. Salon, M. Ravdas, I. Federico, G. Zodiatis, C. Ferrarin, G. Verri, G. Cossarini, M. G. Sotillo, A. Cucco, R. Sorgente, B. Moure, I. Vilibić, S. Sarmmartino, G. Coppini and E. A. Fanjul</i>	
Downscaling the Copernicus CMEMS Med-MFC in the Eastern Mediterranean: The new CYCOFOS forecasting systems at regional and sub-regional scales	305
<i>G. Zodiatis, G. Galanis, A. Nikolaidis, H. Radhakrishnan, G. Emmanouil, G. Nikolaidis, R. Lardner, S. Sofianos, S. Stylianou, M. Nikolaidis, V. Vervatis and G. Kallos</i>	

North-West European Shelf Monitoring and Forecasting Centre: system evolution since the beginning of CMEMS <i>M. Tonani, N. Mc Connell, R. King, E. O'Dea, M. Martin, P. Sykes, A. Ryan, A. Saulter and S. Kay</i>	311
Evolution of the IBI MFC Services along the CMEMS Phase I (2015-2018): Success stories and Future Challenges <i>M.G. Sotillo, S. Cailleau, L. Aouf, C. Toledano, T. Dabrowski, P. Rey, R. Aznar, B. Levier, R. Rainaud, E. Barrera, P. Bowyer, A. Rodríguez, P. Lorente, G. Reffray, A. Pascual, A. Dalphinnet, J. Villasuso, A. Amo-Baladrón, M. Benkiran, A. Feijo, J.M. García-Valdecasas, I. López and E. Álvarez-Fanjul</i>	319
Ensemble-based data assimilation of observations into NEMO-Nordic <i>L. Axell and Y. Liu</i>	327
Last improvements in the data assimilation scheme for the Mediterranean Analysis and Forecast system of the Copernicus Marine Service <i>J. Pistoia, E. Clementi, D. Delrosso, G. Mattia, C. Fratianni, M. Drudi, A. Grandi, D. Paleletti, P. Di Pietro, A. Storto and N. Pinardi</i>	335
The roles of the sea ice thickness measurements from satellites in the TOPAZ system <i>J. Xie, L. Bertino, A. Melsom, A. Burud and M. Müller</i>	343
Towards a new sea level forecast system in Puertos del Estado <i>I. Pérez González, B. Pérez Gómez, M. G. Sotillo and E. Álvarez-Fanjul</i>	353
Bio-ARGO as a potential source of regular validation and model improvement in an operational biogeochemical model <i>V. Ç. Yumruktepe and A. Samuelsen</i>	361
Particle transport model sensitivity on wave-induced processes in the forecasting coupled model system <i>J. Staneva, A. Behrens, M. Ricker, O. Krüger, A. Wiese, R. Carrasco, Ø. Breivik and C. Schrum</i>	367
Analysis of Biochemical Time Series from RADMED Monitoring Program at IEO <i>M.C. García-Martínez, M. Vargas-Yáñez, F. Moya, J.L. López-Jurado, M. Serra, R. Santiago, A. Aparicio, E. Tel, J.A. Jiménez and R. Balbín</i>	371
Data, products and services	377
The SAMOA initiative: Operational Oceanography at the service of the Ports <i>E. Álvarez Fanjul, M. García Sotillo, B. Pérez Gómez, J. M. García Valdecasas, S. Pérez Rubio, Á. Rodríguez Dapena, I. Martínez Marco, Y. Luna, E. Padorno, I. Santos Atienza, G. Díaz Hernández, J. López Lara, R. Medina, M. Grifoll, M. Espino, M. Mestres, P. Cerralbo and A. Sánchez Arcilla</i>	379
HNS-MS: Improving Member States preparedness to face an HNS pollution of the Marine System <i>S. Legrand, S. Le Floch, L. Aprin, V. Partenay, E. Donnay, S. Orsi, N. Youdjou, R. Schallier, F. Poncet, S. Chataing, E. Poupon and Y.-H. Hellouvy</i>	387
The Copernicus Marine Service User Uptake programme: a way to show the value added chain till the end users <i>S. Cailleau, G. Chabot, A. De Nuccé, C. Derval, E. Durand and D. Obaton</i>	395
The new CMEMS IBI-WAV forecasting system: skill assessment using <i>in situ</i> and HF radar data <i>P. Lorente, M.G. Sotillo, L. Aouf, A. Amo-Baladrón, E. Barrera, A. Dalphinnet, C. Toledano, R. Rainaud, M. De Alfonso, S. Piedracoba, A. Basáñez, J. M. García-Valdecasas, P. Montero and E. Álvarez-Fanjul</i>	401

Satellite data based automated arctic sea ice monitoring system <i>L. Bobylev, V. Volkov, E. Kazakov and D. Demchev</i>	409
Stress testing the EU monitoring capacity for the Blue economy <i>N. Pinardi, G. Manzella, S. Simoncelli, E. Clementi, E. Moussat, E. Quimbert, F. Blanc, G. Valladeau, G. Galanis, G. Kallos, P. Patlakas, S. Reizopoulou, C. Kyriakidou, I. Katara, D. Kouvarda, N. Skoulikidis, L. Gomez-Pujol, J. Vallespir, D. March, J. Tintoré, G. Fabi, G. Scarcella, A. N. Tassetti, F. Raicich A. Cruzado, N. Bahamon, F. Falcini, J.-F. Filipot, R. Duarte, R. Lecci, A. Bonaduce, V. Lyubartsev, C. Cesarini, G. Zodiatis, S. Stylianou, J.-B. Calewart and B. Martín Miguez</i>	415
EMODnet Physics: tackling new challenges <i>A. Novellino, P. Gorringe, D. Schaap, P. Thijsse, S. Pouliquen, L. Rickards and G. Manzella</i>	423
The In situ component of the CMEMS – Copernicus Marine Environment Monitoring Service – <i>L. Petit de la Villéon, S. Pouliquen, and CMEMS INSTAC partners</i>	431
CORA 5.0: global in situ temperature and salinity dataset <i>T. Szekely, J. Gourrion, S. Pouliquen and G. Reverdin</i>	439
Virtual access activity in JERICO-NEXT: guiding users to relevant services and data <i>V. Créach, A. Novellino, K. Collingridge and M. Devlin</i>	447
Societal benefits from observing and modelling systems – pilot actions in Ireland in the framework of the AtlantOS project <i>T. Dabrowski, C. Cusack, K. Lyons, J. Silke and E. O'Rourke</i>	453
Emerging needs on operational oceanography to serve sustainable development in Baltic-North Sea <i>J. She</i>	463
Development of operational oceanography system for fishery management and its application in the Central North Pacific Ocean <i>T. Wakamatsu, H. Igarashi, Y. Tanaka, S. Nishikawa, S. Ishizaki and Y. Ishikawa</i>	473
Improving the IEO/NODC activity by a distributed and coordinated infrastructure <i>E. Tel, L. Arranz, A. Cabrero, I. Chamarro, G. González-Nuevo, P. Otero and A. Viloria</i>	481
The Data Lifecycle at SOCIB: responding to scientific and societal needs <i>C. Muñoz, C. Troupin, J. G. Fernández, B. Frontera, P. Rotllán, I. Ruíz, M. Gomila, S. Gómara, F. Notario, M. Charcos, D. March, B. Casas, E. Heslop, D. Álvarez, L. Gómez-Pujol, M.A. Rújula and J. Tintoré</i>	485
Geo-Scientific Platform as a service: Tools and Solutions for efficient access to and Analysis of Oceanographic Data <i>M. Wergeland Hansen, A. Korosov and A. Vines</i>	491
Data sharing tools for the Southern Ocean Observing System <i>P. Bricher, S. Diggs, J. Beja, and B. Pfeil</i>	495
Index of Authors	501
List of Participants	509
EuroGOOS Member Organizations 2018	515

EUROGOOS CONFERENCE 2017 STATEMENTS

Major developments have taken place in operational oceanography in recent years particularly in the enhanced networking and cooperation among ocean observing and data aggregation initiatives and in the development of the Copernicus Marine Environment Monitoring Service (CMEMS) and associated products and services for users. Marine research infrastructures have in some cases transitioned to full legal entities providing robust, timely and quality assured data to the operational oceanography and wider scientific community. The polar oceans will also receive more attention in the coming years through the Year of Polar Prediction and projects including the European Commission's INTAROS project focused on the Arctic observing system. In coastal seas, there is significant activity to raise the technology readiness of key observing technologies, to enhance predictions in coastal areas, to incorporate more routine collection of biogeochemical measurements, and to provide better services to users in all European sea basins including enhanced satellite products. Acoustic technologies have developed rapidly in recent years and are increasingly used in operational oceanography.

The 8th EuroGOOS international conference, titled Operational Oceanography in Service of Sustainable Marine Development, took place in Bergen, Norway, on 3-5 October 2017. The event was co-hosted by the Institute of Marine Research, IMR, and the Nansen Environmental Remote Sensing Centre, NERSC, and co-organized with the EuroGOOS office. Delegates from 24 countries and many international, European and regional networks attended. The programme included two plenary sessions running on the first and last days of the conference, a poster session, and a day-long splinters session featuring 54 talks across the marine observation and data value chain.

The EuroGOOS conference discussed major developments in operational oceanography in recent years. Cooperation among ocean observing and data aggregation initiatives have progressed strongly since the previous conference in 2014, noted Erik Buch, EuroGOOS chair, in his opening speech. Furthermore, several marine research infrastructure networks have transitioned to full legal entities towards a robust and timely data delivery for a wide range of users. Biogeochemistry observations have also progressed considerably, as did the awareness of the critical importance of those measurements.

The 8th EuroGOOS conference 2017 has highlighted:

- Progress in linking and aligning European ocean observing stakeholders and initiatives towards building an integrated and sustained European Ocean Observing System (AtlantOS, INTAROS, ODYSSEA, JERICO, EMSO-ERIC and others);
- Integrating and aggregating European marine data to enhance its societal and economic potential (Copernicus Marine Service, EMODnet, SeaDataNet, and others);
- Community priorities regarding the evolution of the Copernicus Marine Environment Monitoring Service;
- The role of marine research infrastructures in the operational oceanographic system;
- New initiatives under way for polar seas (observation and predictive capabilities);
- Key new technologies for coastal operational oceanography;
- The role of acoustic technologies in the ocean observing system;
- The ongoing efforts to integrate ocean observing and data initiatives at a global level, meeting societal, policy and economic needs.

EuroGOOS has played an important role facilitating dialogue and synergy across actors and promoting the value of ocean observing services to science, policy and blue economy. The conference demonstrated the importance of an end-to-end and fit-for-purpose oceanographic system. In this respect, the EuroGOOS work facilitating an integrated European Ocean Observing System, undertaken with the European Marine Board, is very important to achieve reliable and sustained oceanographic services.

Over the next 3 years EuroGOOS and its member organisations will continue to advocate for sustained ocean observations in Europe and for the enhancement of the overall number of observing platforms collecting biogeochemical data. This strategy will be aligned with global efforts to systematically measure Essential Ocean Variables (EOVs) in physics, biogeochemistry and biology and ecosystems.

Through the European Ocean Observing System, EuroGOOS in partnership with European Marine Board will create a forum whereby funders, operators and users of ocean observations can interact, collaborate and enhance Europe's ocean observing system. Central to this will be a concerted programme of work to gather a comprehensive set of requirements from users of ocean observations to ensure that

the observing system is entirely fit for purpose and that any investments have a strong justification.

EuroGOOS will continue to promote the free and open exchange of oceanographic data to serve a wide range of end users. EuroGOOS will encourage key organisations to contribute data to data aggregators such as the Copernicus Marine Environment Monitoring Service (CMEMS), the European Marine Observations and Data Network (EMODnet) and to long term archiving initiatives including Seadatanet.

EuroGOOS will also work with other GOOS Regional Alliances to develop capacity in ocean observing, forecasting and ocean service development. We will particularly strengthen existing partnerships with MONGOOS and Black Sea GOOS.

EuroGOOS will continue to define priorities for operational oceanography in Europe, promote cooperation and collaboration among oceanographic organisations in Europe and further afield and encourage co-production and technology transfer in the development of oceanographic products and services to underpin sustainable maritime development.

Presentations at the 8th EuroGOOS Conference have demonstrated a community that continues to utilise ocean observations to produce high quality assessments of past, current and future ocean state. These assessments and forecasts form the basis for products and services to maritime industries. The underlying data also provide the basis for regional sea and climate assessments. Europe remains well positioned to take a global lead in the field of operational oceanography.



**OCEAN OBSERVATIONS:
OBSERVING NETWORKS
AND SENSORS**

THE STRATEGY FOR EVOLUTION OF ARGO IN EUROPE

C. Gourcuff ⁽¹⁾, J. Buck, R. Cancouët, H. Claustre, J. Haapala, H. Heinrich, D. Kassis, B. A. King, B. Klein, G. Korres, G. Maze, K. A. Mork, G. Obolensky, D. O'Conchubhair, E. O'Rourke, P. M. Poulain, S. Pouliquen, A. Sterl, V. Thierry, P. Vélez and W. Walczowski

⁽¹⁾ EURO-ARGO ERIC, 1625 route de Sainte Anne, 29280 Plouzané, France.
Claire.Gourcuff@euro-argo.eu

Abstract

Euro-Argo is a European Research Infrastructure for observing the Ocean. In addition to its contribution to the core-Argo programme, one of the main challenges for Euro-Argo is to implement the next phase of Argo with an extension towards biogeochemistry (e.g. oxygen, biology), the polar oceans, the marginal seas and the deep ocean. Meeting such challenges is essential for the research and the long-term sustainability and evolution of the Copernicus Marine Service. Euro-Argo has recently revised its deployment's strategy for the next decade. This paper presents this strategy and provides some highlights on the implementation-plan for the years to come.

Keywords: Argo floats, ocean observing system, deployment strategy, network extensions

1. Introduction

The international Argo programme is a major element of the global *in situ* ocean observing system. More than 3700 floats are now globally measuring temperature and salinity throughout the whole ocean down to 2000 meters depth, delivering data both in real time for operational users and after careful scientific quality control for climate change research and monitoring. The Euro-Argo research infrastructure organizes and federates the European contribution to Argo. Started as a FP7 EU project in 2008, Euro-Argo became a European Research Infrastructure Consortium (ERIC) in 2014, that involves 11 countries (Fig. 1). The objective of the Research Infrastructure is to coordinate and sustain the European contribution to the global Argo network, with around 250 European Argo floats deployed per year (1/4 of the network), through both national and European funds.

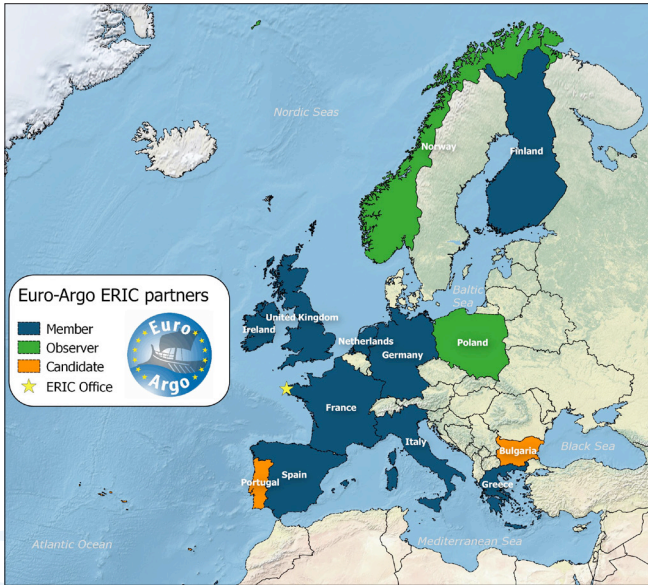

Fig. 1. Euro-Argo ERIC members and Observers as of 1st January 2017.

The main challenges for Euro-Argo for the coming years are to sustain the core-Argo programme and to implement the new phase of Argo with an extension towards biogeochemistry, the polar oceans, the marginal seas and the deep ocean. In 2016, Euro-Argo has revised the strategy for the evolution of Argo in Europe, in a new version of the document (Euro-Argo ERIC, 2016). This reference document will be revised regularly taking into account both technological developments and the international Argo strategy. It provides recommendations on Argo floats deployments, including insights on the European contribution to the core-Argo programme, and sections dedicated to the Argo extensions.

2. Core-argo and marginal seas

2.2 Contribution to the core-Argo mission

Euro-Argo ensures that the European deployments fulfil both the international Argo programme requirements in terms of global geographical repartition and the European scientific and operational oceanography community's needs. The European contribution to the core Argo is enabled through both national and EU funds (MOCCA – Monitoring the Ocean and Climate Change with Argo - project, EASME grant). The Atlantic Ocean is a region of great interest for the European research community, and float deployments will be continued in this ocean, with a specific attention on keeping the appropriate sampling in equatorial and boundaries regions (twice the classical sampling).

2.3 South European Seas

The Mediterranean and Black Seas are strongly affected by human activities and climate change, and defined by variability scales much smaller than the global ocean. The aim is to double the Argo sampling in these southern Europe Seas, with 60 active floats at all time in the Mediterranean Sea and at least 10 active floats in the Black Sea (Fig. 2), with cycles of 5 to 10 days and parking depths adapted to the region.

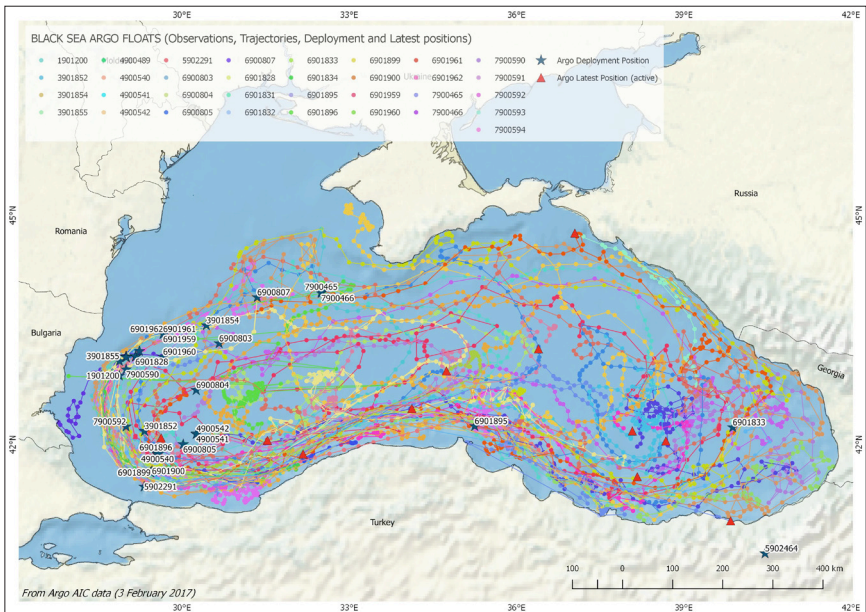

Fig. 2. Argo Float observations in the Black Sea since first deployments in 2002.

Continuous assessments of the chosen float parameters are necessary and will be performed.

2.4 Baltic Sea

Argo activity in the Baltic Sea started in 2011 by Finland. The recommendation for the Baltic Sea is to keep 7 active floats at all time, with a precise repartition within the several basins. Recovering the floats on an annual basis is planned, with redeployment after laboratory calibration. The Baltic Sea with its seasonal sea ice cover could also serve as a test bed for the development of Argo floats operating in sea ice environments. The gained expertise could then be exploited in the development of floats for the Arctic Ocean.

3. Biogeochemical argo

The progressive addition of new bio-optical (oxygen, Chl_a fluorescence, backscattering, radiometry) and other chemical sensors (nitrate, pH) to the system starts to let Biogeochemical-Argo (BGC-Argo) become a reality (Johnson and Claustre, 2016).

A target size of 1000 fully equipped BGC-Argo floats with uniform regional distribution is anticipated for the global array, which corresponds to 25 % of all Argo floats. Euro-Argo aims at contributing to $\frac{1}{4}$ of the global effort, with an additional effort put on equipping half of the whole European fleet with oxygen sensors. Regional refinement is proposed depending on the interest of the research community for biogeochemical monitoring in specific seas or regions and it is expected that the European contribution will boost the BGC-Argo global network development.

4. Deep Argo

Many recent studies have highlighted the crucial contribution of the intermediate, deep and abyssal oceanic layers to the global energy and sea level budgets. Pilot experiments have demonstrated the capability of floats to make interesting measurements up to 4000m and 6000m depth (Fig. 3). Sensor development is continuing as well as evaluation of the design of the Deep-Argo array proposed by Johnson *et al.* (2015).

On the long term, the target for the European contribution to the Deep-Argo array is about 20% of the international target, which, based on the Johnson *et al.* (2015)'s straw-plan would correspond to about 240 active floats. The strategy for Deep Argo is to first focus on areas where large deep signals are located, that is where deep-water masses are formed, namely the North-Atlantic Ocean and the Southern Ocean.

The core (2000m) and deep (4000m) Argo boxes together cover almost 90% of the ocean volume (Le Reste *et al.* 2016). While 4000m Deep-Argo floats are sufficient to sample the entire water column in the North-Atlantic Ocean, 6000m Deep-Argo floats should be preferred where the ocean is the deepest and especially in the Southern Ocean where warming of the abyssal layers is the largest.

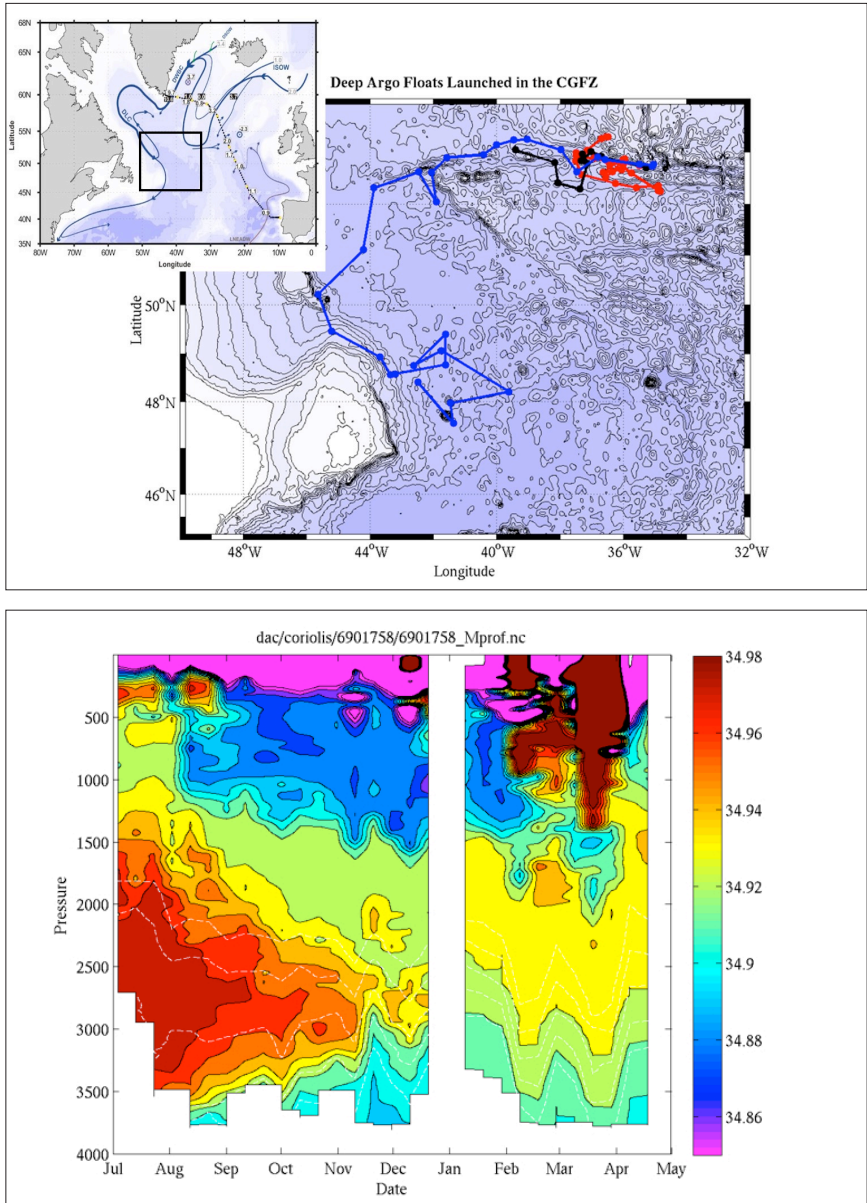

Fig. 3. Southward trajectory of the deep Argo float 6901758 (blue) between deployment (July 2015) and May 2016 (top) and one year time series [2015-2016] of salinity measured by the float (bottom) – Courtesy of G. Maze and V. Thierry.

5. High latitudes extension

At present, the use of floats in the polar oceans is seriously impeded by the presence of sea ice. Nevertheless, the high latitudes are key regions of the global climate system and thus need to be monitored. Ice-avoidance algorithms for Southern Ocean, first developed by AWI for NEMO floats, have been successful in reducing damage to floats deployed in the seasonally ice-covered Southern Ocean. Euro-Argo aims at maintaining 50 active floats in the Weddell Gyre based on the nominal design density. In the northern hemisphere, other direct methods of ice-sensing, especially based on optical measurements, are being tested for the ice-covered high latitudes in the Baffin Bay (NAOS project).

Using the core-Argo target, the Euro-Argo recommendations include that a total of 39 Argo floats should be active in the Nordic Seas, among which 1/4 within the boundary currents, with a parking depth of 500m (Fig. 4).

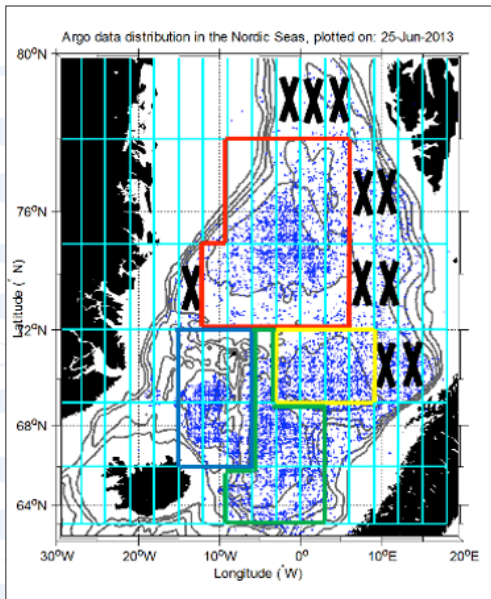

Fig. 4. $3^{\circ} \times 3^{\circ}$ boxes for deployments: 10 floats in boundary currents, 29 in deep basins. Red: Greenland Sea, blue: Icelandic Plateau, yellow: Lofoten Basin, Green: Norwegian Basin.

With the ongoing technological development, a further extension of the global Argo array in to the ice-covered areas of the Northern high latitudes - including Arctic - is envisioned (at about 5 years).

6. Conclusion

The objective of Euro-Argo to account for ¼ of the global Argo is progressing. Thanks to funds from the European Union (MOCCA project), the European contribution to the core-Argo mission and monitoring of the European marginal Seas is increasing. Euro-Argo has started to implement the new phases of Argo. Recent studies conducted at European level have shown that Biogeochemical (BGC) Argo technology is mature, and the deployments of fully equipped BGC floats has started. The Deep-Argo technology pilot phase is still ongoing to reach the accuracy needed for climate applications and work is also ongoing regarding sea-ice technology that will enable Euro-Argo to extend its capacity to high latitudes.

The implementation plan of the deployment strategy depends on the lifespan of the floats. This key indicator, that is expected to evolve based in particular on technological improvements, will be assessed continuously. The detailed numbers of floats to deploy provided in Euro-Argo ERIC (2016)¹ to achieve the targets will thus have to be refined accordingly in the following years.

References

- Euro-Argo ERIC (2016): Strategy for evolution of Argo in Europe, v3.2. DOI: 10.13155/48526
- Johnson, K. S., and H. Claustre (2016): Bringing biogeochemistry into the Argo age, *Eos*, 97, <https://doi.org/10.1029/2016EO062427>.
- Johnson, G. C., J. M. Lyman and S. G. Purkey (2015): Informing Deep Argo Array Design Using Argo and Full-Depth Hydrographic Section Data, *Journal of Atmospheric and Oceanic Technology* 32, DOI: 10.1175/JTECH-D-15-0139.1
- Le Reste, S., V. Dutreuil, X. André, V. Thierry, C. Renaut, P. Y. Le Traon and G. Maze (2016): "Deep-Arvor": A New Profiling Float to Extend the Argo Observations Down to 4000-m Depth, *Journal of Atmospheric and Oceanic Technology* 33, DOI: 10.1175/JTECH-D-15-0214.1

TOWARDS AN INTEGRATED EU DATA SYSTEM WITHIN ATLANTOS

S. Pouliquen⁽¹⁾, V. Harscoat⁽²⁾ and AtlantOS WP7 partners⁽³⁾

⁽¹⁾ IFREMER Plouzané, France. Sylvie.pouliquen@ifremer.fr.

⁽²⁾ IFREMER Plouzané, France. Valerie.Harscoat@ifremer.fr

⁽³⁾ AtlantOS WP7 partners. atlantos_wp7_coordination@ifremer.fr

Abstract

One goal of the H2020 AtlantOS project is to ensure that data from different and diverse in situ observing networks are readily accessible and useable to the wider community, international ocean science community and other stakeholders in this field. To achieve that, the strategy is to move towards an integrated data system within AtlantOS that harmonizes work flows, data processing and distribution across the in situ observing network systems, and integrates in situ observations in existing European and international data infrastructures or Portals, termed Integrators (e.g. Copernicus INS TAC, SeaDataNet NODCs, EMODnet, ICES, EurOBIS, GEOSS).

The actors of the integrated system, networks and integrators, are overall mature systems with long-term experience and established procedures for data collection and management. Consequently, trying to implement a sovereign and rigid set of rules for all the actors to comply with, would have been highly challenging and not in the best interest of AtlantOS. Therefore network and integrator representatives collaborated to achieve three main objectives: describe the situation at the beginning of the project, agree on a minimum set of recommendations on data harmonization and data integration, and set up a roadmap towards the integrated system.

Keywords: Data Management, Standards, Integration, EuroGOOS, JCOMM, Copernicus, SeaDataNet, EMODnet

1. Introduction

The H2020 AtlantOS project started in June 2015 and aims to optimize and enhance the Integrated Atlantic Ocean Observing Systems. One long term goal of AtlantOS is to ensure that data from different and diverse *in situ* observing networks are readily accessible and useable to the wider community, including international ocean science community and other stakeholders in this field. To achieve that, the strategy is to move towards an integrated data system within AtlantOS that harmonizes work flows, data processing and distribution across the *in situ* observing network systems, and integrates *in situ* observations in existing European and international data infrastructures and Portals, termed Integrators. The targeted integrated system shall deal with data management challenges for efficient and reliable data service to users: (1) quality control commons for heterogeneous and nearly real time data, (2) standardization of mandatory metadata for efficient data exchange and (3) interoperability of network and integrator data management systems.

1.1 The actors of the integrated system

The **networks** involved in Data integration for AtlantOS are Ship-based observation Networks (GO-SHIP, VOS/SOOP, CPR, fish and plankton surveys, seafloor mapping), Autonomous observing Networks (Argo, Gliders, Drifters, OceanSITES, EATN) and Coastal observing systems (Ferrybox, FOS, coastal profilers, fixed moorings).

Some Networks are organized with DACs and GDACs components. A DAC is a Data Assembly Centre typically operating at either the national or regional scale. A DAC manages data and metadata for its area with a direct link to scientists and operators, and pushes observations to the network GDAC (Global Data Assembly Centre). The GDAC is designed for a global observation network (e.g. Argo, OceanSITES, EGO for Gliders, etc) and aggregates data and metadata provided by Network DACs, in RT (Real Time) and DM (Delayed Mode). Therefore it's a portal to access, at any time, the "best version" of the Network data.

The European infrastructures or global assembly centres involved as integrators in AtlantOS are:

- For marine environmental data: SeaDataNet for validated and archived data; and the In situ Thematic Assembling Centre (INS TAC) component of Copernicus Marine Environment Monitoring Service (CMEMS) for NRT data and for the past 60 years of historical data assembled for reanalysis needs;
- For marine biodiversity data: the ICES system and EurOBIS.

The Portals involved as **integrators** in AtlantOS are:

- At European level : EMODnet lots (physics, chemistry, bathymetry, biology) fed by Copernicus Marine INS TAC, SeaDataNet and EurOBIS;
- At international level: GEOSS.

1.2 The roadmap towards the integrated system

To summarize the situation at the beginning of AtlantOS project in 2015, the data acquired by the different *in situ* observing networks were processed and distributed using different methodologies and means. Depending on the network, the data were either processed following recommendations elaborated by the network and made accessible through a unique portal (FTP or Web), or were processed by individual scientific researchers and made available through National Data Centres or at the Institution level. Some datasets were available through Integrators by ad-hoc links that were developed in past years within projects such as Copernicus, EMODNet, SeaDataNet, etc.

By exploring the data landscape, the partners in WP7 identified the needs for improvements to facilitate the access to the broad array of Atlantic observations and avoid “mixing apples and oranges”, which will be to the benefit of all the actors and the users. Therefore, relying on existing European and international standards and protocols, the partners first agreed on common standards for metadata and data description (Koop-Jakobsen *et al.*, 2016), and recommendations for NRT QC of selected Essential Variables (Reverdin *et al.*, 2016). Then a data exchange backbone was designed to facilitate discovery, viewing and downloading by the users, along with tools that can be set up to at network level to plug the data on the backbone, and to facilitate integration into the Integrators. And finally it was identified that services to the users shall be enhanced to ease access to existing observations. All the guidelines for both networks and integrators are available in the Data Management Handbook (Harscoat e Pouliquen, 2016).

Time has come for the actors of the integrated system to begin the Implementation phase that aims to feed operational models and facilitate enhanced products from AtlantOS data. The networks are going to implement the recommendations for standardization across networks, plan NRT QC procedures enhancement if needed and facilitate access to network data. The integrators are going to enhance their tools for data integration (network data ingestion, viewing and downloading services on network data, cross network assessments and feedback to networks, traceability and monitoring facilities for providers and users) and to enhance the services to users (facilitate discovery through catalogues, provide OGC services, provide enhanced download facilities, facilitate visibility of existing data and provide gap identification).2. Design of the integrated system

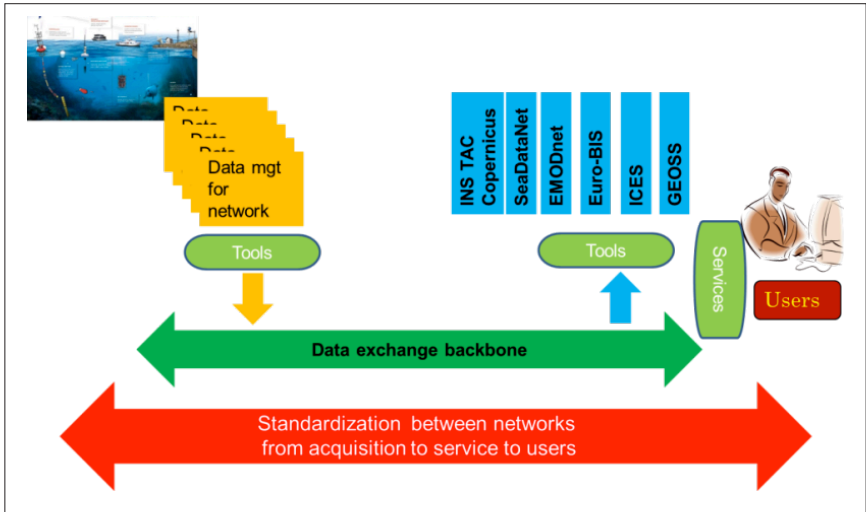

Fig. 1. The EU integrated data system, in green and red the interfaces addressed in AtlantOS.

2.1 Harmonization across networks

The actors, networks and integrators, of the future system have agreed on a set of minimum requirements and provided guidelines for best practice on essential data management aspects that will ensure cross platform coherence and facilitate better data discovery and integration. Following, the charted minimum requirements and guidelines for AtlantOS are listed.

Distribution means

As the minimum requirement for delivery service, an FTP service at the level of Network data management shall be provided. Additional services such as Web services can also be provided but are not mandatory.

Across network mandatory metadata

As a minimum, two metadata are required as mandatory in the data files and the associated platform catalogues from AtlantOS. They guarantee a continuum between data-platform-institution in an unambiguous way across the Networks and help in the traceability of the datasets. The first one is a unique ID identifying are platform and/or station identifiers and the code data provider codes. The two catalogues agreed for unique IDs management are: (1) C17 controlled vocabulary of SeaDataNet listing the codes for all platforms except stations, and (2) ICES station directory for stations. The second catalogue is more suitable as a station can be relocated and then spatial metadata are needed.

The objective of the second mandatory metadata is to give visibility to the Institutions that provide data by including in a data file the code of the Institution registered in EDMO (European Directory of Marine Organizations developed under SeaDataNet). Compared to free text, a code harmonizes the information and optimizes the discovery of datasets and allows feedback to Institutions on traceability of use.

AtlantOS set of Essential Variables

The networks in AtlantOS offer a wide variety of marine data related to many different scientific disciplines from standard parameters such as common physical ocean measurements to specialized variables such as isotopes of O₂, N₂, and Fish and Plankton surveys. An AtlantOS Essential Variables list of terms (aggregated level), related to ECV –EOV or other, has been defined and integrated in the NERC/BODC Vocabulary Server as A05 vocabulary (available online at https://www.bodc.ac.uk/data/codes_and_formats/vocabulary_search/A05/), together the mapping with existing EU (SeaDataNet vocabularies) or international (CF or WoRMS for Taxa) vocabulary standards. Each Network has to define the mapping between the metadata for the parameters in their data and the standards recommended. By doing this, a Network allows mapping on the fly without having to change its datasets.

NRT QC for selected EOVS

A core of seven AtlantOS essential variables (temperature (T), Salinity (T), Current for surface and subsurface, Sea level, Oxygen (O₂), Chlorophyll-A, Nitrate (NO₃) and Carbon (pCO₂) for surface and subsurface) are selected for implementation of common Quality Control procedures because they are acquired and controlled in NRT (24h to several days) by more than one Network among the Networks involved in AtlantOS integration activity. The recommendations have been compiled by experts on those EVs and validated by the networks acquiring those EVs and performing NRT QC. Also the harmonization recommendations include QC information to be attached to the data: both Quality flags that can be mapped to the SeaDataNet flag scale and when known processing level information (“qualified in NRT using automated procedures” or “processed in DM by Scientist”).

2.2 Data exchange backbone

Platform catalogue

A simple catalogue technique was formulated (recommendation is available online: <http://dx.doi.org/10.13155/45063>) to be used at network global data assembling (GDAC) or portal level to (1) facilitate for users the discovery of platforms and data files, and (2) set up monitoring services. It consists of populating, continuously (creation and update) on file arrival/update, two types of indexes as simple ASCII files besides the data files made available on FTP. This technique is already implemented at the Copernicus INS TAC (content at the end of 2015: 100 000 data files and 30000 platforms). Such index files are useful for setting up synchronization between the GDAC and the user space. They can also be used to create KPIs (Key Performance

Indicators) for monitoring purposes on the networks availability, statistics on institutions or countries providing data, maps of the latest data available parameters provided delays, etc.

Detailed network and platform metadata

Concerning the metadata for platform type and sensors, it was agreed that it was an issue to be solved at Network level and that harmonization across networks was not seen as a priority. Nevertheless, a recommendation to implement SensorML for sensors whenever possible will be issued in partnership with other projects such as FIXO3, ODIP2, ENVRI+, SeaDataCloud.

AtlantOS catalogue

The AtlantOS catalogue (under construction at <https://www.atlantos-h2020.eu/atlantos-catalogue>) is the entry point to the integrated data system of AtlantOS. This catalogue is implemented with the GeoNetwork component of the Sextant Spatial Data Infrastructure and will also feed to the GEOSS common infrastructure.

It provides a discovery service to users and it facilitates the access to existing services (viewing, downloading and monitoring) customized to show the Atlantic Ocean as defined within AtlantOS. This catalogue firstly exposes the actors of to the integrated system and their services. It also aims to link to the monitoring services under JCOMMOPS umbrella and finally to expose the AtlantOS products. The content of the catalogue and the user services are going to be made available progressively as the integrated system is being set up, especially during the implementation phase of the project (from end of March 2017).

Implementation of data citation

To be able to operate observing systems on a long-term basis, operators are often asked to provide evidence that their platform data are essential not only for their study but also for multiple uses. Sharing data with other communities contributes to foster multiple uses of observations but makes it more difficult to trace its effective use.

In the past years, a lot of progress has been made on data citation with DOI (Digital Object Identifier). DOIs can be assigned by networks to documents and datasets for two main objectives: (1) Citation (in a publication the DOI is efficiently tracked by bibliographic surveys) and (2) Traceability (the DOI is a direct and permanent link to the document or data set used in a publication).

A guideline for the best practice for DOI assignment to AtlantOS data was formulated and is available online: <http://dx.doi.org/10.13155/44515>

3. Data integration and services to users

To facilitate access to AtlantOS data it has been decided to work at two levels:

- At Networks level to provide integrated access to all available data. The importance of enhancing services at the Network level is that data managers are close to platform operators and can design the system to fit the platform specificities.
- At Integrators level that build thematic services for additional targeted users and will be able to enhance their services with the help of the Networks (integration, update process, archive, etc.).

3.1 Facilitate access to Network data

The way to facilitate access to Network data for users is to set up a central point from where the data can be uploaded, or rely on existing Integrators to distribute more widely their data. This central point can be either a GDAC for the Network, or a portal with files on FTP and/or web services, allowing machine-to-machine downloading and sub-setting services.

3.2 Enhance integration in Integrators and services to users

To facilitate access to AtlantOS data it has been decided to work at two levels:

- All Integrators are planning to connect to new Network GDACs that are setting up to achieve:
 - A more complete data coverage in time and space;
 - Better quality of the integrated data as update processes will be easier;
 - Extension to more biogeochemistry data essential for Ecosystem modelling;
 - Facilitate also links between Integrators (Copernicus INS TAC <-> SeaDataNet, Copernicus INS TAC <-> EMODnet);
- All Integrators are updating their data system to implement the AtlantOS recommendations on metadata and vocabularies for parameters;
- Surveys were performed to identify the AtlantOS data that were not integrated yet, and activities are going on with Networks to improve the situation for Copernicus INS TAC, SeaDataNet and consequently EMODnet;
- Implement traceability of AtlantOS observations and use methods, and develop monitoring tools and dashboards;
- AtlantOS is contributing to GEOSS through different channels including teaming up with ODIP and in addition is promoting its use as the central hub to discover environmental data and information. However, as the GEOSS Common Infrastructure is going through a transitional phase, AtlantOS will explore the best strategy for taking new initiatives like the GEOSS European Data Hub into account.

4. Conclusion

The benefit for the Atlantic community will be at different levels. For the Network operators, it allows targeting new users through wider data availability. They also take advantages of new tools and methods to improve traceability of use and monitoring of the network data availability. Furthermore they will be able to implement internationally agreed recommendations for data citation strategy and mapping between network parameters and AtlantOS Essential Variables.

Operational users will have access to enhanced products with extended time and space coverage for present parameters (T&S Current Sea Level Wave O2 Chl) both for forecast and reanalysis, but also access to enhanced products for Ecosystem model validation. The benefit will probably be more visible in European Seas, but collaboration started also for international partnership and integration of new platforms. In addition the research community will also benefit of enhanced quality of the historical products in partnership with the Networks and the Integrators.

Finally new monitoring tools will allow the AtlantOS coordination to have more visibility on what data is freely available for users and provide inputs for the elaboration of the AtlantOS Blueprint, which aims at providing an integrated vision and plan for Atlantic Ocean observations.

Acknowledgements

As the minimum requirement for delivery service, an FTP service at the level of Network data management shall be provided. Additional services such as Web services can also be provided but are not mandatory.

References

- Koop-Jakobsen, Waldmann, Huber, Harscoat, Pouliquen (2016). *Data Harmonization Report*. AtlantOS project. D7.1. [https://www.atlantos-h2020.eu/download/deliverables/7.1 Data Harmonization Report.pdf](https://www.atlantos-h2020.eu/download/deliverables/7.1>Data%20Harmonization%20Report.pdf)
- Harscoat, Pouliquen (2016), *Data Management Handbook*. AtlantOS project. D7.4. <https://www.atlantos-h2020.eu/download/7.4-Data-Management-Handbook.pdf>
- Reverdin, Thierry, Utiz, d'Ortenzio, Bradshaw, Pfeil (2016). *QC Report*. AtlantOS project. D7.2. <https://www.atlantos-h2020.eu/download/7.2-QC-Report.pdf>

JERICO-RI: THE INTEGRATED COASTAL COMPONENT OF THE EUROPEAN OCEAN OBSERVING SYSTEM

P. Farcy⁽¹⁾, D. Durand⁽²⁾, I. Puillat⁽¹⁾, G. Petihakis⁽³⁾ and J. Tintoré⁽⁴⁾

⁽¹⁾ IFREMER Centre de Brest, Plouzané, Brest, France - jerico@ifremer.fr.

⁽²⁾ COVARTEC, Durand Research & Consulting, Bergen, Norway

⁽³⁾ HCMR, Institute of Oceanography, Hellenic Centre for Marine Research, Heraklion Crete, Greece

⁽⁴⁾ SOCIB, Mallorca, Spain

Abstract

JERICO, the European research infrastructure of coastal observatories (JERICO-RI) is an ocean observing system of systems, designed to provide high-quality data that are supporting knowledge development on the complex and often coupled physical, chemical and biological processes characterizing the coastal waters of Europe. JERICO-RI integrates several observing platform types i.e. fixed buoys, piles, moorings, drifters, Ferrybox, gliders, HF radars, coastal cable observatories and the associated technologies dedicated to the observation and monitoring of the European coastal seas. The RI is to serve both the implementation of European marine policies and the elucidation of contemporary and future key scientific questions. It therefore includes observations of the physical, chemical and biological compartments and aims at a better integration of marine biology with physical and chemical oceanology.

The first phase of the implementation of the JERICO-RI encompassed setting up, integrating and harmonization of existing coastal observing systems around Europe into a system of systems, covering all European coastal waters from the Baltic Sea to the Black Sea. It was performed between 2011 and 2015 in the framework of JERICO-FP7, a 4-year long infrastructure project co-funded by the European Commission, with 27 partners from 17 European countries under the coordination of IFREMER. The second 4-year phase is presently in progress through the H2020 JERICO-NEXT project, which started in 2015 and involves 34 scientific and industrial partners. The main objective of the JERICO-RI consortium is to establish a common strategy towards a sustainable coastal observing system of systems for Europe supporting with data and knowledge innovation and blue growth in Europe.

This paper briefly summarizes the work carried out since 2011 and the present drivers of the JERICO-RI science strategy. It also drafts the strategical elements of the JERICO-RI sustainability.

Keywords: JERICO, JERICO-NEXT, Coastal Observatory, system of systems, harmonization, sustainability, open access, Blue Growth

1. Background and rationale

Threats and pressure to coastal areas are increasing; would it refer to increase in coastal population, degradation of coastal habitats, increased pollution, greater demand for non-living resources (renewable energy), or over-fishing that result in declines in ecosystem health and biodiversity. Consequently one experiences an increase demand of data and *in situ* observations as the backbone for better understanding the changes in the coastal environment and the processes involved. It raised the need for automated and long-autonomy platforms and sensors systems suitable to deliver high quality and comprehensive data. Over the last years, the EU has been contributing to answering this demand by promoting extensive cooperation for the observation of the global ocean, supporting key research infrastructure (RI) projects such as EURO-ARGO (www.euro-argo.eu) and EMSO (www.emso-eu.org), as components of the upcoming European Ocean Observing System (EOOS), with the aim to serve different users of the maritime domain. Indeed, Policy-makers are promoting the exploitation of research-driven marine technologies and data towards innovation, business development and wealth creation in Europe. This is a crucial driver for decision-making for maritime industries and this is giving an explicit framework, in addition to scientific and environmental concerns, for developing a strategy for coastal observation in Europe.

The rationale for improved observations of coastal seas is to provide the data backbone supporting knowledge development for sustainable growth in the coastal zone, as the region of highest economic potential in Europe. Moreover, the coastal component of the European marine observing system is to serve both the implementation of European marine policies and the elucidation of key scientific questions through dedicated observations and long-term monitoring strategy. The coastal seas are characterised by complex processes depicting high coupling and feedbacks between physical, chemical, geochemical and biological compartments in the water column, at sea-bottom and between pelagic and benthic compartments. Furthermore, coastal seas are under combined pressures of anthropic origins through coast-land interactions (river run-off and diffuse outfalls from land), atmospheric disposals, and long-distance transported chemical and biological compounds. Therefore a coastal observing system must encompass a wide range of measurements, covering different disciplines and environmental compartments, and addressing the interaction between them. Furthermore the system should enable a better understanding of the variability of biological, chemical and physical processes and its causes, would it be natural, anthropogenic or climatic. An appropriate sampling strategy in time and space addressing the heterogeneity of the coastal waters is hence paramount. These requirements lead to the concept of observing system of systems for appropriately addressing the specificities of the coastal ocean. The concept relies on the integration of different observing platforms, different sensors and measurement technologies into a harmonised network that delivers high-quality, consistent and comprehensive datasets describing the coastal environments and the pressure upon them.

Because of development of coastal observatories in Europe has been driven by domestic interests and mainly undertaken through short-term research projects, significant heterogeneity exists concerning technological design of observing systems, measured parameters, practices for maintenance and quality control, as well as quality standards for sensors and data exchange. Therefore main challenges for the coastal research community have been to harmonize the technologies, increase the coherence and the sustainability of these dispersed infrastructures by sharing know-how through dedicated actions and experiments within a shared pan-European framework.

These considerations led 27 leading marine research institutions from 17 European countries to establish the Joint European Research Infrastructure network of Coastal Observatories (referred to as JERICO-RI). The main objective of the JERICO-RI community has been to establish a common approach for a pan-European coastal observing system of systems (marine observatory network).

2. JERICO-FP7: Main achievements

The first phase of the implementation of the JERICO-RI were carried out within the JERICO-FP7 Infrastructure project (2011-2014), co-funded by the European Commission in the 7th Framework Programme. JERICO-FP7 addressed the challenge of observing the complexity and high variability of coastal areas at Pan-European level, in the framework established by European Directives (Water Framework Directive: WFD, Marine Strategy Framework Directive: MSFD) and the marine core service of the European Earth observation programme (Copernicus) by (i) setting up an European Research Infrastructure for coastal observations by **integrated existing systems** in European coastal and shelf seas, (ii) supporting **standardization of methodologies** for the benefit of data quality, data availability and cost efficiency, (iii) promoting the **cost-effective use of the facilities**, (iv) stimulating the **development of new automated systems** for the operational monitoring of the coastal marine environment, with focus on the biochemical compartment.

JERICO-FP7 focused on several observing platforms broadly used around Europe, i.e. **fixed buoys, piles, moorings, ferrybox and gliders**, building upon existing regional networks in Europe, including the European Global Ocean Observation System (EuroGOOS). JERICO-FP7 has contributed to address the challenge of observing the complexity and high variability of coastal areas at Pan-European level.

2.1 JERICO-FP7 Networking Activities

JERICO-FP7 led to the definitions of best practices for the design, implementation, maintenance and distribution of coastal observing systems, as well as the definition of quality standards. The work was supported by ongoing initiatives and projects from “platform” communities, such as the Glider community (GROOM project) and the well-established Ferrybox community. The need for harmonization for Fixed Platforms were considered as stronger since a “fixed platforms” community does not exist per se and a huge variability of technologies is encountered for these types of platform. Standard Operation Procedures (SOP’s) were documented and a best practice code was developed. This is reported in JERICO-FP7 best practice reports (www.Jerico-ri.eu) [1], [2], [3], [4]

2.2 JERICO-FP7 Joint Research Activities

Joint research activities were conducted in order to identify new and strategic technologies to be implemented in the next generation of European coastal observatories. Focus was given on the observation of the biochemical compartment, and Observing System Experiments (OSE) / Observing System Simulation Experiments (OSSE) to evaluate the impact of existing data observing networks on coastal forecasting capability through data assimilation. The new technology and methodology developments addressed (i) image and video analysis of the biological compartment, (ii) measurement of the carbonate system ($p\text{CO}_2$, alkalinity and spectrophotometric pH detection) and the quantification of the air-sea CO_2 fluxes, (iii) measurement of nutrients and contaminants.

2.3 JERICO-FP7 Trans National Access activities

Access to JERICO-RI was provided through Trans-National Access to research scientists outside the project consortium. The selection was made following open calls and based on scientific excellence. The objective was to promote the potential of JERICO-RI facilities and platforms when used in synergy. 12 articles presenting significant results of JERICO-FP7 are published in a Special Issue of the “Journal of Marine System”, volume 162 [5].

3. JERICO-NEXT: The way forward

The JERICO-FP7 project was the first European wide effort towards the harmonisation and coordination of the major coastal observing platforms including FerryBox, gliders, and coastal fixed platforms. Started in September 2015, the JERICO-NEXT project, involving 34 scientific and industrial partners, builds upon this basis and enlarges the objectives to complementary observing systems including biological observations, with the aim to better understand the specific characteristics of European coastal waters. The overarching objective of JERICO-NEXT is to strengthen and enlarge a solid and transparent European network of coastal observatories and to provide an operational service for the timely, continuous and sustainable delivery of high quality environmental (physical, biogeochemical and biological) data and related to

the coastal environments. By doing so, JERICO-NEXT helps the research community to provide the best possible quality indicators for the MSFD and to promote joint research initiatives and standardization, increasing support to the European industrial sector of coastal instrumentation and monitoring services.

3.1 The JERICO-NEXT vision

JERICO-NEXT has at the heart the statement that we cannot understand the complexity of the coastal ocean if we do not understand the coupling between physics, biogeochemistry and biology. Reaching such an understanding requires new technological developments allowing for the continuous monitoring of a larger set of parameters. It also clearly requires an a priori definition of the optimal deployment strategy in view of coupling diverse data monitored over very different spatial and temporal scales.

3.2 Objectives of JERICO-NEXT

Therefore JERICO-NEXT: (1) focuses most its efforts on the assessment of the interactions between physics, biogeochemistry and biology, and (2) is not restricted to pure technological aspects but also includes fundamental scientific considerations within its Networking Activities (NAs). Both aspects are closely associated within JERICO-NEXT Joint Research Activities (JRAs).

One main objective is to provide the researchers with continuous and more reliable coastal data coupling physical and biological information. Furthermore, JERICO-NEXT aims to demonstrate the adequacy of observing technologies and monitoring strategies to provide the information necessary to address a selected set of major environmental issues such as the assessments of: (1) Good Environmental Status as required by the MSFD; and (2) global environmental change impacts on coastal ecosystems. This is addressed through six Joint Research Activity Projects, internal to JERICO-NEXT.

Furthermore, JERICO-NEXT is (i) continuing addressing standardization issues along the value-chain from sensors to data management, and providing access to the RI and data (ii) carrying out joint research activity projects feeding the overall strategy for sustainability of the RI, (iii) preparing for future development of the RI, and (iv) making data available through EMODNET and CMEMS data channels.

Since many environmental issues taking place in the coastal ocean are linked with biological compartments and processes, it is essential not to restrict observed variables to current (candidate) Essential Ocean Variables but to include biological and biogeochemical variables that cannot be acquired in real time or even near real time in view of their relevance regarding the specific environmental issues tackled by each subsystem. The concept of **Essential Coastal Variables** is therefore being consolidated by the JERICO-RI community. It will be introduced in a revised version of the Best

Practices for coastal observatories, and will lead to recommendation on evolutions of EMODNET.

Coastal modelling is a key tool for providing continuity between observations and for providing sound services (e.g. maps and forecasting) to end-users. It is currently much more developed for geophysical than for biogeochemical and even less for biological processes. The complexity of coastal processes points the fact that more *in situ* observations are needed to constrain the models. It is suggested that a future monitoring programme of the European Coastal Ocean should develop a federative action regarding the development and the harmonisation of models (a function, which is currently devoted to IOOS OPerationS division in the US).

The present observing system of systems (JERICO-RI), and its possible evolution, are continuously assessed taking into account the evolution of users' needs, emerging technologies, progress in term of automation and platform integration.

4. Conclusion and perspectives

Maritime and coastal regions are considered as key areas for achieving a substantial economic growth in Europe. This focus uniquely positions the **JERICO-RI** to provide data and knowledge that would enable an environmentally sustainable use of the coastal domain, thereby responding to societal demands.

Dedicated scientific strategies have to be thought through, agreed upon and implemented according to local specificities and broader scientific objectives, in order to strengthen the understanding of the coastal processes, to better inform policy makers as well as to contribute to science, we need sustained comprehensive and consistent data on physical, chemical and biological parameters collected at appropriate time and space scales.

Results from the JERICO-FP7 project and the ongoing analyses within JERICO-NEXT strongly emphasize the fact that the many specificities of coastal processes requires the development of an **integrated network of coastal observatories** that delivers high frequency *in situ* collected physical and/or biogeochemical data, from the sea-shore to the shelf break from a range of platforms, complementing each other for addressing the high spatio-temporal variability inherent to coastal regions.

A major challenge relates to the sustainability of JERICO-RI, both at economical and governance level, and the capability of integrating the latest technology while preserving the scientific value of the data.

Based on these considerations, the JERICO-NEXT community states that the societal needs, the economic potential and the scientific challenges inherent to the European

Coastal Ocean can be properly addressed only by building a strong, specific and coastal-focused observing system of systems, having a dedicated strategy aiming at supporting the sustainable development of European coastal regions. This observing system would provide the coastal component of an emerging European coastal Ocean Observing System (EOOS); the latter possibly providing the ultimate governance structure that would link the different building-blocks of European Ocean observations, being open-ocean research infrastructures (Euro-Argo, EMSO), RIs related to the biological compartment (EMBRC, LifeWatch) and the proposed integrated coastal component, and achieve a European integrated ocean observing system, contribution to GEOSS.

Acknowledgements

The JERICO-FP7 and JERICO-NEXT projects are funded respectively by the European Commission's FP7 Framework Programme, under grant agreement No.262584, and H2020 Framework Programme, under grant agreement N°. 654410.

References

- [1] "Report on current status of Ferrybox" (Hydes *et al.*, 2014) – JERICO deliverable 3.1
- [2] "Report on current status of Glider" (Tintoré *et al.*, 2014) – JERICO deliverable 3.2
- [3] "Report on best practice" (Petihakis *et al.*, 2012) – JERICO deliverable 4.3
- [4] "Report on Calibration Best Practices" (Petihakis *et al.*, 2014) – JERICO deliverable 4.2
- [5] "Progress in marine science supported by European Joint Coastal Observation System: The JERICO-RI research infrastructure (Puillat *et al.*, 2016) – Journal of Marine Systems, special Issue, Vol. 62.

DEPLOYMENT OF NEW OBSERVING SYSTEMS WITHIN THE JERICO-RI

I. Puillat⁽¹⁾, A. Carlier⁽¹⁾, J.V. Facq⁽²⁾, A. Rubio⁽³⁾, P. Lazure⁽¹⁾, L. Delauney⁽¹⁾, G. Petihakis⁽⁴⁾, B. Karlson⁽⁵⁾, F. Artigas⁽⁶⁾ and P. Farcy⁽¹⁾

⁽¹⁾ IFREMER Centre de Brest, Plouzané, Brest, France - jerico@ifremer.fr

⁽²⁾ IFREMER Centre de Boulogne sur mer, France

⁽³⁾ AZTI, Pasaia, Spain

⁽⁴⁾ HCMR, Heraklion Crete, Greece

⁽⁵⁾ SMHI, Göteborg, Sweden

⁽⁶⁾ CNRS-LOG, Wimereux, France

Abstract

A key message of the JERICO-RI consortium (2014): “The complexity of the coastal ocean cannot be well understood if interconnection between physics, biogeochemistry and biology is not guaranteed. Such integration requires new technological developments allowing continuous monitoring of a larger set of parameters”. In agreement with this consideration, several new observing systems are developed, tested and deployed in the framework of the JERICO-NEXT H2020 project, amongst which a few of them will be presented as well as some preliminary results after the first deployments. Focus will be given on coastal transports and hydrology and on benthic biodiversity. In the first case, we will present a low cost 2D moored system dedicated to acquire vertical temperature profiles in shallow waters and its application to study the high frequency hydrodynamics. In addition, during one of the campaigns foreseen for testing these new systems in an area covered by HF radar, hydrographic and current measurements in the water column, together with phytoplankton and plastic sampling, were conducted. In the second case, attention will be drawn on a new floating pulled system dedicated to observe benthic habitat without disturbing it.

Keywords: JERICO, JERICO-NEXT, Coastal, Ocean Observing System (OOS), Harmonization

1. JERICO-RI: A European Research Infrastructure for coastal observation

1.1 Context and objectives

The past developments of various coastal observation systems in European countries are difficult to sustain on long term in the context of economic restriction and despite the growing need for coastal integrated monitoring. Indeed, most of the existing observation systems were developed and deployed to answer specific purposes according to the scientific interest of the involved institutions or research teams, often leading to the implementation of systems and actions in reduced places and times without efficient enough concertation. Moreover, wishing to sustain observations on long term for monitoring and observations purposes, institutes and states face difficulties to engage means without a clear enough vision on the science and socio-economy strategy behind the observing systems. These considerations drove the coastal community to gather efforts since 2010 towards the harmonization of the existing systems in a European recognised research infrastructure dedicated to the coastal observation: the JERICO-RI (www.jerico-ri.eu). Consequently, was born the first phase JERICO-FP7 project, co-funded by European Commission from 2011 to 2015, as described by Farcy *et al.* (2017).

Although significant progress has been achieved, the way toward an harmonised pan european infrastructure capable to answer science needs and socio-policy requirements is long. The first phase project was dedicated to start with the easiest but important systems, it gathered and harmonised some existing automated and semi-automated systems including the so-called Fixed platforms, Ferryboxes and Gliders. Being aware of the preliminary nature of this work, the FP7 consortium concluded in 2014 *"The complexity of the coastal ocean cannot be well understood if interconnection between physics, biogeochemistry and biology is not guaranteed. Such integration requires new technological developments allowing continuous monitoring of a larger set of parameters"*. This premise was the main idea behind the successful JERICO-NEXT proposal for co-funding in the H2020 programme between 2015 and 2019 under the grant agreement 654410. JERICO-NEXT gathers a consortium of 34 partners under the coordination of Ifremer.

Now, the JERICO-RI is integrating additional platform types such as drifters, HF radars, coastal cabled observatories along with the associated technologies dedicated to observe and monitor coastal European seas. Overall, emphasis is given on a better integration of the physics with the biogeochemistry and the biology and this is reflected in the main objectives of the JERICO-NEXT project:

- Strengthening a solid European network and promoting the infrastructure toward several kinds of users;
- Integrating key observing platforms, and harmonisation from the sensors to the data flow;
- Developing further the collection of biological data;
- Defining scientific strategies based on science integration;
- Proposing legal and economical frames for the sustainability of the infrastructure.

1.2 Scientific priorities and organisation

The will of a better integration has been deeply applied in the project definition thanks to the implementation of six specific scientific priorities, derived along and across the workflows. The ultimate objective behind this objective is to establish a strategy that stems from scientific and societal issues to their technological implementation. Threats and pressure to coastal areas are increasing; would it refer to increase in coastal population, degradation of coastal habitats, increased pollution and greater demand for non-living resources. In response to this, the six scientific priorities are: I) The pelagic biodiversity, II) The benthic biodiversity, III) The chemical contaminant occurrence, and related biological responses, IV) The coastal ocean hydrography and transports, V) The carbon fluxes and carbonate systems, VI) The operational oceanography.

These are specifically addressed with the development of technologies and methods in a technology work package, and also in 6 so-called Joint Research Activity Projects (JRAPs). These JRAPs are dedicated to apply and improve these developments thanks to a feedback after deployment and to support and improve the definition of science strategies according to the 6 priorities. The purpose of this document is to give a short overview on two of them: the here above referred scientific priorities II) and IV).

2. Science and some new observing systems in JERICO-NEXT

Several important achievements have been obtained from the beginning of JERICO-NEXT project. Although most of the work is still in progress, the main preliminary results are presented here in an attempt to illustrate how these research activities will help to identify new and strategic technologies to be implemented in the next generation of European coastal observatories.

2.1 Benthic Biodiversity and habitats

A new towed underwater video system (TUVS), called 'Pagure-2', has been developed by Ifremer in the context of JERICO-NEXT JRAP2, to map habitats, describe biodiversity and monitor ecological changes in benthic ecosystems. The technical objective of this task was to modify an existing system ('Pagure') in order to expand the range of accessible benthic habitats, to get more stable footage on irregular and hard bottoms, and to investigate fragile ecosystems (e.g., marine protected areas) where impact has to be limited. Thus, we proposed the Pagure-2 as a more versatile system that could be deployed either on a classical 'sledge' mode or on a 'flying' mode that reduces contact with the sea floor.

This tool is easily deployable on small (~25 m) coastal vessels as well as large research vessels and was designed to cope with a 10-500m operating depth range and with all kind of sea conditions and currents. It is also simple to use opportunistically on different kind of scientific cruises (benthic survey, fisheries stock assessment, hydrology, etc...) and without any dedicated specialist staff. The Pagure-2 supports a new buoyancy system (10 independent syntactic foam-modules) that significantly reduces its weight in water and two easily removable skates (Fig. 1a). This strategy allows deploying the system on a classical 'sledge' mode (with skates) or a 'flying' mode (without skates, but with 4 weights to adjust the distance to the bottom) (Fig. 1b).

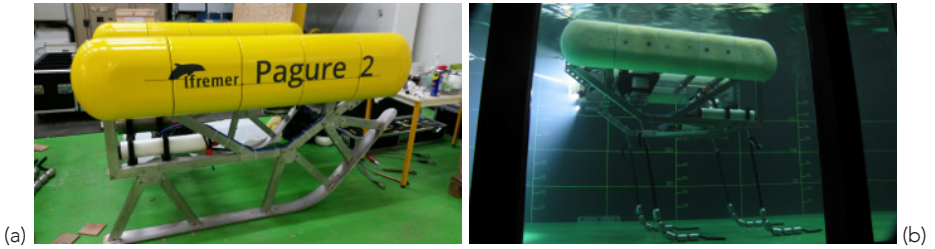

Fig. 1. View of the Pagure-2 on 'sledge' mode with its skates (a) and on 'flying' mode with flexible weights (b). (© Ifremer, J.V. Facq).

An HD video camera, positioned in front at angle of 35°, can capture biodiversity data (visible mega- and macro-epibenthic organisms; flora, invertebrates and fish) and information on the physical characteristic of the visited benthic habitat (nature of bottom; anthropogenic footprints). Two laser pointers allow estimating the size of the identified organisms. A vertical still camera offers an even better resolution and is a complementary sensor to assess the density, coverage, size and ecological state (alive vs. dead) of the most frequent encountered taxa. The steel-frame of the TUVS has been designed to integrate 10 kg of additional sensors in order to measure important environmental parameters like bottom temperature and salinity (which can be very different from the surface layer in circumlittoral areas), oxygen, chlorophyll-a and turbidity). This could help to better characterize the ecological status of visited benthic habitats.

The development of the Pagure-2 will allow more comprehensive insights into the integrity of benthic habitats and will be relevant to investigate areas adversely affected by human activities (e.g., bottom-trawling, sand-mining, marine renewable energy development).

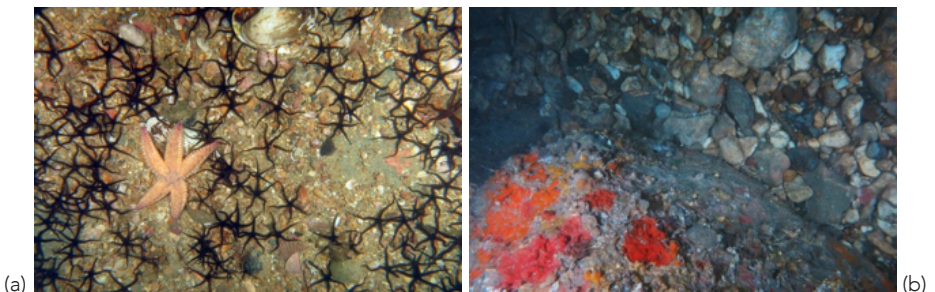

Fig. 2. Examples of still images taken with the vertical camera ('sledge' deployment mode) during the Pagure-Next cruise in the Bay of Brest, showing the quality obtained on various benthic habitats: heterogeneous muddy a) and pebbles b) (© Ifremer, 2016). and on 'flying' mode with flexible weights (b). (© Ifremer, J.V. Facq).

2.2 Coastal ocean hydrodynamics and transports

Surface transport at coastal areas is driven by a large variety of processes (tides, current instabilities, coastal jets, eddies, fronts...) acting simultaneously, in response to different forcing and over a broad spectrum of time-space scales. These processes play a key role in the dispersal/retention of pollutants, planktonic species (potentially toxic), and more generally in cross-shelf exchanges. The characterization and better predictability of these processes and the associated transport along the water column is critical to understand the physical/biological coupling in the coastal zone and to ensure the effective management of coastal areas, where the use of the marine space is concentrated.

Two important achievements were driven in this context thanks to JERICO-NEXT: a technological development, the MASTODON-2D, to study higher frequency phenomena such as internal waves, and new research for the integrated study of coastal mesoscale processes and their impact in surface transports. The technology presented here is dedicated to measure the temperature variation in time on several points of the vertical in shallow waters less than 150m deep. The purpose is to study short-term variation of the stratification to assess the influence of strong internal waves in the mixing of the water column. The idea rose after the successful deployments of low-cost moorings in 2014, which were 1D systems, so-called MASTODON, dedicated to register bottom temperature at high frequency with a 0.1°C precision, every ~10min during a few months for a total cost of about €300 per unit (Lazure *et al.* 2015). It consisted in extending the system by using it as a vector with a vertical line where low cost temperature sensors are attached at selected depths (fig. 3a). Ifremer upgraded its system from 1D to 2D measurements. Equipped with a chain of thermistors they allow to build high spatial resolution monitoring arrays, so coastal internal waves can be accurately observed in both cross and alongshore directions.

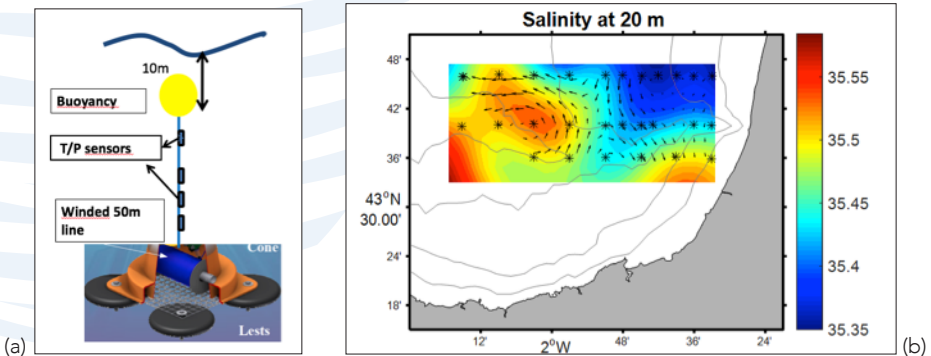

Fig. 3. Two technology and methodology developments in JERICO-NEXT: MASTODON 2D mooring (a) and temperature, salinity and geostrophic velocities at 20m (ETOILE campaign) (b). The positions of the CTD stations are marked using asterisks.

In summer 2017 the deployment of MASTODON-2D moorings in the NW Mediterranean and the SE Bay of Biscay was completed. In the SE Bay of Biscay the deployment of 9 MASTODON-2D moorings was carried out during the ETOILE campaign (July-August 2017). In addition a multidisciplinary experiment was conducted, with CTD, MVP, ADPC, surface drifters, real time monitoring of phytoplankton and plastic sampling in collaboration with the LIFE LEMA project (LIFE15 ENV/ES/000252). Moreover, the ETOILE campaign was conducted in an area covered by HF radar which provides continuous monitoring of surface currents and allows the quantitative estimation of surface transports (e.g. Solabarrieta *et al.* 2017). Preliminary results from the CTD data suggest that a well-defined front was sampled, with colder fresher shelf waters closer to the coast (fig. 3b). The integrated analysis of the data from the campaign with remote sensing observations (satellite and HF radar) will help to understand how the observed mesoscale front conditioned the distribution of biodiversity and marine litter (analysis of data still in progress).

The integration of multiplatform data and, namely, data for HF radars is the main driver also for the other two study areas: the NW Mediterranean and the German Bight, where similar experiments are in progress, with CNR, CNRS, and HZG partners. The researches based on the integration of HF radar and multiplatform data are focusing on methodological improvements for data processing and analysis to improve the quality of surface current estimates from HF radars and for the integration of radar surface information with vertical information from other components of the observing system.

2.3 Some other scientific focuses

With focus on the pelagic biodiversity in phytoplankton and HAB (priority i)), the difficulty stands in capturing the bloom events that vary a lot according to the season, the region and the environmental conditions. In that case, JERICO-NEXT methodology development deals with phytoplankton automated measurement methods: comparison and deployment according to the trophic and environmental water characteristics thanks to several platform types (<http://www.jerico-ri.eu/2017/07/31/phytoplankton-biodiversity-investigated-with-novel-methods/>).

In the framework of the scientific priority iii), by combining the unique sampling facilities and logistic offered by JERICO-RI with the power of state of the art mass spectrometers, some artificial sweeteners were identified as possibly the most abundant micro-pollutant of emerging concern so far identified in marine waters (<http://www.jerico-ri.eu/2017/07/24/case-study-on-marine-contaminants-artificial-sweeteners/>).

Progress is still on the way and results for other scientific priorities are to come soon.

3. And After...

These dynamic activities going beyond a project's lifetime include continuous efforts towards harmonization in terms of design, operation, and maintenance, and in terms of evolution and extension of the current systems as well as the delivery of data and products to the users. To reach this main target an important work needs to be coordinated farther from FP7-JERICO to JERICO-NEXT, and after, at both hardware and software levels. More specifically, the existing network and its possible evolution are continuously assessed taking into account the harmonization effort to be driven, the existing sensors and technologies, their upgrades for integration on dedicated platforms, also the accompanying of the development of low TRL sensors and/or systems with involvement of providers and stakeholders when possible. Nevertheless, the main issue deals with the sustainability of the infrastructure by considering its economics and its governance framework on long term, in addition to the scientific and technological one. This is reflected by the key message acknowledged by the JERICO-NEXT consortium in 2017: *"Coastal focus uniquely positions the JERICO-RI Coastal Observing network to respond to the pressing societal questions, and by doing so, to engage with key maritime stakeholders, both government and commercial - including flooding and coastal erosion, sustainable marine resources, MPAs and CZM, aquaculture, shipping, climate change adaptation."* Consequently, our next steps are not so much led by the development of technologies and methodologies, but more by the need to engage several stakeholder types on a sustainable model.

Acknowledgements

The JERICO and JERICO-NEXT projects are funded respectively by the European Commission's FP7 Framework Programme, under grant agreement No.262584, and H2020 Framework Programme, under grant agreement No.654410.

References

- Farcy P., Durand D., Puillat I., Petihakis G., Tintore J. (2017) "JERICO to JERICO-NEXT: a strategy for a European Network of Coastal Observatories", *Proceeding of the 8th EuroGOOS conference, Bergen, 3-5 Oct. 2017*, this issue.
- Lazure P., Le Berre D., Gautier L. (2015). Mastodon Mooring System To Measure Seabed Temperature Data Logger With Ballast, Release Device at European Continental Shelf. *Sea Technology* , 56 (10), 19-21
- Solabarrieta, L., Frolov, S., Cook, M., Paduan, J., Rubio, A., González, M., Mader, J., Charria, G. (2016). Skill assessment of HF radar-derived products for lagrangian simulations in the Bay of Biscay. *J. Atmos. Oceanic Technol.*, in press, doi: 10.1175/JTECH-D-16-0045.1.

Weisberg, R. H., Lianyuan Z., Yonggang L. (2015) Chapter 4 - Basic Tenets for Coastal Ocean Ecosystems Monitoring, In *Coastal Ocean Observing Systems*, Academic Press, Boston, Pages 40-57, ISBN 9780128020227, <http://dx.doi.org/10.1016/B978-0-12-802022-7.00004-3>.

THE POSEIDON SYSTEM, AN INTEGRATED OBSERVING INFRASTRUCTURE AT THE EASTERN MEDITERRANEAN AS A CONTRIBUTION TO THE EUROPEAN OCEAN OBSERVING SYSTEM

L. Perivoliotis⁽¹⁾, G. Petihakis⁽¹⁾, M. Korres⁽¹⁾, D. Ballas⁽¹⁾, C. Frangoulis⁽¹⁾,
P. Pagonis⁽¹⁾, M. Ntoumas⁽¹⁾, M. Pettas⁽¹⁾, A. Chalkiopoulos⁽¹⁾, M. Sotiropoulou⁽¹⁾,
M. Bekiari⁽¹⁾, A. Kalampokis⁽¹⁾, M. Ravdas⁽¹⁾, E. Bourma⁽¹⁾, S. Christodoulaki⁽¹⁾,
A. Zacharioudaki⁽¹⁾, D. Kassis⁽¹⁾, M. Potiris⁽¹⁾, G. Triantafyllou⁽¹⁾, A. Papadopoulos⁽¹⁾,
K. Tsiaras⁽¹⁾ and S. Velanas⁽¹⁾

⁽¹⁾ Institute of Oceanography, Hellenic Centre for Marine Research, Greece. lperiv@hcmr.gr

Abstract

The scarcity of oceanic observations of the air-sea interaction together with the oceanic processes (coastal, open, deep ocean) in the proper spatial and temporal scales under long-term recording schemes is one of the challenges that a European Ocean Observing System should meet. This is mainly due to the complexity of the marine environment in conjunction with the technological barriers. In the Mediterranean Sea, the existing gaps in the observing facilities are high, especially in the eastern part of the basin. POSEIDON is one of the very first efforts towards a comprehensive marine monitoring and forecasting system, that aims to improve environmental monitoring and facilitate sea transport, rescue and safety of life at sea, fishing and aquaculture and protection of the marine ecosystem. Over the last few years POSEIDON has adopted a multiplatform-multiparameter approach with the current system's status including open and coastal sea fixed platforms, deep-ocean observatories, a Ferrybox system, HF radar, and Argo autonomous floats. Since 2010, the list of biogeochemical-ecosystems parameters has been expanded by the addition of sediment traps, frequent R/V visits for water-plankton sampling, and of an ADCP delivering information on macrozooplankton-micronekton vertical migration. Gliders and drifters are the platforms currently under integration to the existing system. Land-based facilities, such as data centers, technical support infrastructures, calibration laboratory, mesocosms, provide the added value to the observatory. The collected data enhance the quality of the atmospheric and the marine physical and biogeochemical-ecosystem forecasts as well as the provided wrap-up user oriented services such as the oil spill predictions. Besides replying to scientific questions at regional and international level, the POSEIDON observatory provides services to marine policy-makers and the society, and is a technological

test bed for marine technology. It is evident that, with its present characteristics – a national system with an integrated approach and a centralized management – POSEIDON can be considered as a direct contribution towards EOOS implementation.

Keywords: Operational Oceanography, Aegean Sea, Ionian Sea, observatory, marine technology

1. Introduction

Oceans are complex dynamic systems embracing various physical, chemical and biological processes interacting on a wide range of time and space scales. The increasing anthropogenic pressures add another layer of complexity in their study. Ocean observatories are long-term infrastructures dedicated to multiple *in situ* observations (from air-sea interface to the ocean bottom and the water column) which are maintained over long timescales with adequate temporal resolution and designed to address interdisciplinary objectives over wide spatiotemporal scales. POSEIDON (www.poseidon.hcmr.gr) is such an observatory research infrastructure of the Eastern Mediterranean basin, for the monitoring and forecasting of the marine environment, supporting the efforts of the international and local community and replying to the needs and gaps of science, technology and society. It was developed in three phases under the funding of EEA Financial Mechanism (85%) and Greek National funds (15%): POSEIDON-I (1997-2000), a first-generation buoy monitoring network with operational centres, forecasting system, and relevant human resources; POSEIDON-II (2005-2008), a system upgrade and expansion; and finally POSEIDON-III (2009-2011), a deep sea observing capacity expansion. Recently (2017), an extended upgrade and renewal of POSEIDON buoy network monitoring parts and components and their supporting hardware is realized due to the implementation of an integrated marine monitoring program funded by the EEA Financial Mechanism 2009-2014.

The POSEIDON general aims are a) to establish a sustainable marine observing network in the Eastern Mediterranean, b) to provide quality and validated forecasts of the marine environment, c) to provide scientific knowledge and support on the study of the ocean mechanisms and their variability, as well as to address the sensitivity of marine ecosystem and biodiversity to combined natural forcing factors and anthropogenic pressures, and d) to provide a technology test bed and services to marine policy-makers and the society. The system is being developed in accordance to the policy frameworks suggested by IOC/GOOS, EuroGOOS, MonGOOS and GEO while it maintains a balance between the operational and research character of the infrastructure through the integration of methodologies and tools developed in relevant EU initiatives and projects.

2. A strategic location to study the eastern mediterranean

The Mediterranean Sea, as other seas, also “suffers” by a scarcity of sustained observations, especially for open ocean and for biogeochemical-ecosystem parameters (Ruhl *et al.*, 2011; www.eurosites.info). Understanding Mediterranean Sea’s features may be useful on larger oceanic scales, since the Mediterranean Sea has been considered a “miniature ocean” that can be used as a model to anticipate the response of the global ocean to various pressures (Bethoux *et al.*, 1999). The data provided by POSEIDON in the Aegean and Ionian Seas could be considered as representative of much wider areas, such as the open Cretan Sea’s (South Aegean) biochemistry which has been estimated that it represents an area in the Eastern Mediterranean of $0.6\text{-}1.6 \times 10^6 \text{ km}^2$ depending on the parameter (Henson *et al.*, 2016) (Fig. 1).

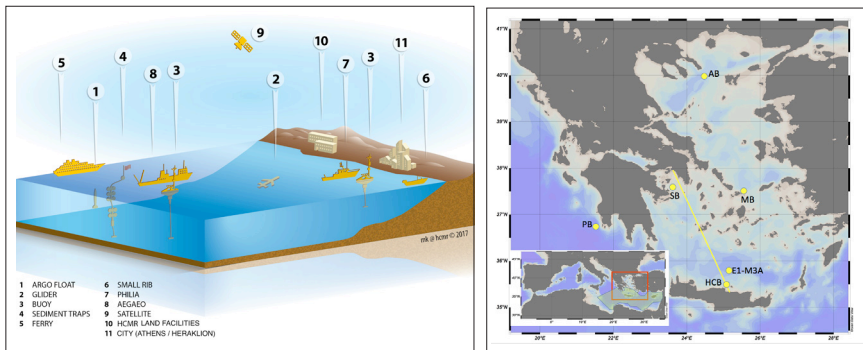

Fig. 1. Left: Platforms of Poseidon observatory (Gliders to be incorporated within 2018). Right: Map showing the location of the POSEIDON system fixed platforms (AB: Athos Buoy, MB: Mykonos Buoy, PB: Pylos Buoy, SB: Saronikos Buoy, E1-M3A Buoy) and Ferrybox route (yellow line). Inset map shows location within the Mediterranean Sea (red square) and E1-M3A spatial footprint (green area) for Chl-a using satellite observations (redrawn after Henson *et al.*, 2016).

As suggested by a number of studies (e.g. Henson *et al.*, 2016), the Eastern Mediterranean Sea is a key area for the understanding of the functioning of the whole basin. However, several questions for its physical and biogeochemical status are still remain. Some examples are given below:

- i) The Aegean Sea plays an important role in the dynamics of the Eastern Mediterranean circulation being an area of intermediate and/or deep-water formation. These areas are also key locations for monitoring of the Mediterranean biochemical functioning (Malanotte-Rizzoli *et al.*, 2014 and references therein).
- ii) The Eastern Mediterranean Basin is considered to be an ultra-oligotrophic system, compared to the rest of the Mediterranean and to other oceans (Siokou-Frangou *et al.*, 2010 and references there in). As riverine nutrient input is very low, atmospheric deposition is believed to be the main source of nutrients in the euphotic zone of the open sea, other than the vertical mixing of water during winter (Christodoulaki *et al.*, 2013 and references therein). The exact contribution to the balance of nutrients and the resulting impact of atmospheric deposition on the productivity remains uncertain and deserves further investigation.
- iii) The Mediterranean Sea also constitutes a hot spot of biodiversity with a uniquely high percentage of endemic species (Coll *et al.*, 2010 and references therein; Siokou-Frangou *et al.*, 2010). However, biodiversity studies are still limited in the Mediterranean (Danovaro *et al.*, 2010; Siokou-Frangou *et al.*, 2010). In addition, the Eastern Mediterranean is more subject to change by alien species in combination with warming (Coll *et al.*, 2010) due to the connection with the Red Sea.
- iv) Little is known about the role of large migrants located at mid and deep waters of the Eastern Mediterranean (review by Saiz *et al.*, 2014), although these organisms can constitute an important active vertical flux increasing the biological pump's efficiency (review by Frangoulis *et al.*, 2005).

3. Components-platforms

The present (2017) status of the POSEIDON observatory includes multiple platforms (Fig. 1) operating at various spatiotemporal scales (Fig. 2).

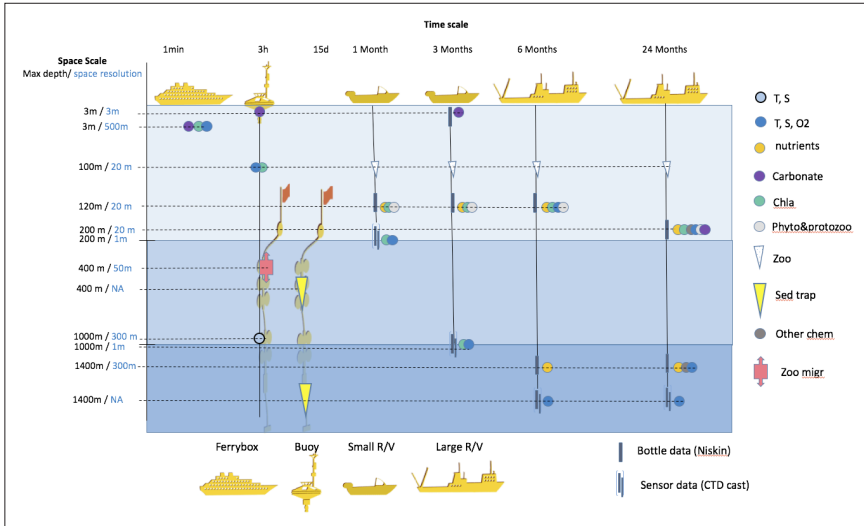

Fig. 2. Time and space resolution of data acquisition by the different platforms of the observatory (Argos, Gliders excluded). Space resolution is vertical except for Ferrybox. Carbonate: pH or CT&AT, Other chem: other chemical parameters, Sed trap: sediment trap, Phyto & protozoo: phytoplankton and protozoans; Zoo: metazoans, Zoo migr: ADCP backscatter data for zooplankton-micronekton migration.

Three Oceanor wavescan buoys are deployed in the S. Aegean (E1-M3A), N. Aegean (Athos) and Ionian waters (Pylos) provide meteorological, physical and biochemical (O₂, Chl-a) data. The POSEIDON E1-M3A buoy, located about 24 nautical miles north of the island of Crete, is the most developed physical-biogeochemical observing site of the POSEIDON system (Petihakis *et al.*, 2006). The ATHOS buoy, placed between Athos peninsula and the island of Lemnos, monitors an area affected by the Black Sea water entering the North Aegean through the Dardanelles straits, which plays a significant role modulating the thermohaline characteristics and dynamics of the whole Aegean Sea. The PYLOS site in the SE Ionian is a crossroad where, intermediate and deep-water masses meet. The site is located on the pathway of the Aegean Sea dense water that travels to the north along the western coast of Greece. Close to the coasts of Athens, Heraklion and Mykonos, three Oceanor Seawatch buoys, the Saronikos Buoy (SB), the Heraklion Coastal Buoy (HCB), and the Mykonos Buoy, provide possibilities to study the coastal-open sea processes interaction (e.g. wave dynamics, exchanges of matter, extreme events spatial extend).

A Ferrybox system (FB) operates on the route connecting the ports of Piraeus (Athens) and Heraklion. This fully automated, flow-through system includes sensors of temperature, salinity, fluorescence, turbidity and pH. FB has been proven a helpful tool in the study of water circulation (e.g. modified Black Sea Water flowing in the Aegean Sea), in particular when assimilated into prognostic numerical circulation models to improve their accuracy (Korres *et al.*, 2014).

Sampling of seawater and plankton is made regularly next to the fixed biochemical platforms and on-board the FB. R/V visits are made at a monthly frequency next to the E1-M3A site and the HCB. They include CTD casts and seawater/plankton sampling. In addition, samples of sinking particulate matter are collected with sediment traps at the E1-M3A. The sampling procedures, storing and analysis protocols follow international recommendations, however adaptations of certain protocols have been made, considering the oligotrophic conditions of the area.

A 75 kHz ADCP placed at the E1-M3A (400m depth, looking upward), allows the study of currents at multiple depths and provides data to analyse the vertical migration patterns (at diel and seasonal scale) of large zooplankton and mikronekton.

The Greek Argo infrastructure (www.greekargo.gr), with 15 deployed floats in 2015 and 2016 (five of which were Bio-Argos) and aiming a total number to 25 ARGO floats, further contributes to the international ARGO community efforts to monitor the Eastern Mediterranean region. It is worth noticing that in the Aegean Sea the ARGO recordings are largely based on POSEIDON floats.

Two SeaExplorer *gliders* were recently added to the monitoring platforms of the POSEIDON system. The two gliders will be gradually integrated to the operational network of the system with the ultimate objective of establishing at least two endurance

lines in the Aegean and Ionian Seas. In the southern part of the Aegean, the Cretan Sea, the continuous monitoring through an endurance line is expecting to contribute to the further knowledge of the seasonal variability of the flow field, collecting also evidences of the intermediate or deep-water formation events that are known to occur in the area. On the other hand, the tracking of the low salinity Black Sea Water path in the North Aegean is an important feature to be studied through a glider endurance line, even if this line is expected to be much more complex to be established due to the existing circulation pattern and the geographical characteristics of the region.

Forecasting tools are centrally placed in POSEIDON system, with a number of state-of-the-art weather, wind waves, ocean circulation and marine ecosystem numerical models, initialization and data assimilation schemes providing 5-days ahead information on daily basis regarding the atmospheric (Papadopoulos *et al.*, 2002), sea state (Korres *et al.*, 2011) and hydrodynamic conditions (Korres *et al.*, 2010) in the Aegean/Ionian Seas and in the Mediterranean, as well as the ecosystem functioning of the whole basin. Currently, the POSEIDON modeling group is providing the wave forecasting products of the Copernicus Marine Environment Monitoring Service (CMEMS) for the Mediterranean Sea in the framework of MED-MFC. General calibration – validation activities are applied to the operational models as data from the observatory are used in conjunction with experiments (e.g. mesocosms) for the analysis and modelling of specific processes (e.g. Tsiaras *et al.*, 2017) or assimilation algorithms of sea colour data are tested and validated in biogeochemical models (Kalaroni *et al.*, 2016).

Interaction with several land-based facilities located nearby the observatory is necessary for sensors maintenance and analysis of discrete samples. The calibration lab, micro- and mesocosms, meteorological stations, and atmospheric deposition station are also key land-based components. In particular the calibration lab, considering the local environmental conditions, is a powerful tool for calibration of sensors deployed in the wider Mediterranean Sea (Bozzano *et al.*, 2013).

The data collected from the different platforms are undergone Quality Control procedures according to EuroGOOS and Oceansites working group standards and methodologies. The POSEIDON Data Center, as the regional data collection unit of the CMEMS, sustains the compatibility of the recorded data with the existing large European data infrastructures (EMODnet, CMEMS and SeaDataNet). Data can be visualized through the POSEIDON web-site (fixed platforms, Ferrybox) and the MonGOOS data portal (<http://www.mongoos.eu/data-center>, all platforms except sediment traps, ADCP), while the data are freely available to the public, the stakeholders and the scientific community.

4. Sustainability, expansion and connection with society

The critical issue for the POSEIDON observatory is its sustainability, as it has been developed through intermittent funding and national incentives. The multiparameter, multiplatform observatory approach allows the participation to various research projects and thus the provision of funds through multiple sources. In addition, the long experience acquired, and particular conditions of the Eastern Mediterranean, makes the observatory an excellent test bed for new technology.

The POSEIDON management team vision considers attaining a near real time (NRT) character also for the biogeochemical parameters together with further expansion of the recorded parameters, with a greater focus in air-sea interaction. Driven by new societal needs, supplementary underwater sensors are recently considered (e.g. marine litter, noise, organic contaminants, etc). An increase of the spatiotemporal coverage is also in view, including the capacity to perform deep biochemical observations, and providing an operational status to the regular *in situ* sampling program. The above will allow to resolve poorly known mechanisms, like the benthic-water column interactions, the functioning of mid-water and deep-water ecosystems, and the plankton-micronekton vertical migration role, the higher trophic level web structure, as well as feedback effects such as the capacity to store CO₂, and the ecosystem feedback on physics (light attenuation).

The expansion vision of POSEIDON system considers recommendations, guidelines and priorities coming out of the national Research Infrastructure road map of observing systems (HIMOFs), review papers, EU goals directives (MSFD, H2020), and visions of European (European Marine Board and EuroGOOS, e.g. EGMRI 2013) and International coordinating bodies (GOOS, GCOS). The POSEIDON system by the expanded NRT data delivery, proxy estimations, hazard mapping, warning systems and higher resolution, besides addressing specific scientific questions, will offer additional products to a wider range of society users, to answer Europe's societal and policy demands for sustainable use of the seas, ecosystem-based management, and establishment of environmental status indicators.

References

- Bethoux, J. P., et al. (1999). The Mediterranean Sea, as miniature ocean for climatic and environmental studies and a key of the climatic functioning of the North Atlantic. *Progress in Oceanography*, 44, 131–146.
- Bozzano, R., et al. (2013). The M3A Network of Open Ocean Observatories in the Mediterranean Sea. *Proceedings of OCEANS 2013 MTS/IEEE*, Bergen, Norway, 10-14 June 2013, pp.1-10.
- Christodoulaki, S., et al. (2013). Atmospheric deposition in the Eastern Mediterranean. A driving force for ecosystem dynamics. *Journal of Marine Systems*, 109-110, 78–93.

- Coll, M., et al. (2010). The Biodiversity of the Mediterranean Sea: Estimates, Patterns, and Threats. *PLoS ONE*, 5(8), e11842.
- Danovaro, R., et al. (2010). Deep-Sea Biodiversity in the Mediterranean Sea: The Known, the Unknown, and the Unknowable, 5(8). *PLoS ONE*, 5(8), e11832.
- Frangoulis, C., et al. (2005). Comparison of marine copepod outfluxes: nature, rate, fate and role in the carbon, and nitrogen cycles. *Advances in Marine Biology*, 47, 251–307
- Henson, S.A., et al. (2016). Observing climate change trends in ocean biogeochemistry: When and where. *Global Change Biology*, 22(4), 1561–1571.
- Kalaroni, S., et al. (2016). Data assimilation of depth-distributed satellite chlorophyll-a in two Mediterranean contrasting sites. *Journal of Marine Systems*, 160, 40–53.
- Korres, G., et al. (2010). Forecasting the Aegean Sea hydrodynamics within the POSEIDON-II operational system. *Journal of Operational Oceanography*, 3, 37–49,
- Korres, G., et al. (2011). A 2-year intercomparison of the WAM Cycle4 and the WAVEWATCH-III wave models implemented within the Mediterranean Sea. *Mediterranean Marine Science Journal*, 12, 129–152.
- Korres, G., et al. (2014). Assimilating Ferry Box data into the Aegean Sea model. *Journal of Marine Systems*, 140, 59–72.
- Malanotte-Rizzoli, P., et al. (2014). Physical forcing and physical/biochemical variability of the Mediterranean Sea: a review of unresolved issues and directions for future research. *Ocean Science*, 10(3), 281–322.
- Papadopoulos, A., et al. (2002). The Poseidon weather forecasting system: an overview. *Global Atmosphere-Ocean System*, 8, 219–237, 2002
- Petihakis, G., et al. (2006). M3A system (2000–2005) – operation and maintenance. *Ocean Science Discussions*, 3, 165–198.
- Ruhl, H.A., et al. (2011). Societal need for improved understanding of climate change, anthropogenic impacts, and geo-hazard warning drive development of ocean observatories in European Seas. *Progress in Oceanography*, 91: 1–33.
- Saiz, E., et al. (2014). The Zooplankton In: S. Goffredo, & Z. Dubinsky (eds.). *The Mediterranean Sea: Its history and present challenges*. Springer Netherlands, Dordrecht, 183–211.
- Siokou-Frangou, I., et al. (2010). Plankton in the open Mediterranean Sea: a review. *Biogeosciences*, 7(5), 1543–1586.
- Tsiaras, K.P., et al. (2017). Model Simulations of a Mesocosm Experiment Investigating the Response of a Low Nutrient Low Chlorophyll (LNLC) Marine Ecosystem to Atmospheric Deposition Events. *Frontiers in Marine Science*, <https://doi.org/10.3389/fmars.2017.00120>

FERRYBOXES WITHIN EUROPE: STATE-OF-THE-ART AND INTEGRATION IN THE EUROPEAN OCEAN OBSERVATION SYSTEM (EOOS)

W. Petersen⁽¹⁾, F. Colijn⁽¹⁾, P. Gorringer⁽²⁾, S. Kaitala⁽³⁾, B. Karlson⁽⁴⁾, A. King⁽⁵⁾,
U. Lips⁽⁶⁾, M. Ntoumas⁽⁷⁾, J. Seppälä⁽³⁾, K. Sørensen⁽⁵⁾, G. Petihakis⁽⁷⁾,
L.P. De La Villéon⁽⁸⁾ and H. Wehde⁽⁹⁾

⁽¹⁾ Helmholtz-Zentrum Geesthacht, Germany. wilhelm.petersen@hzg;

⁽²⁾ EuroGOOS AISBL, Belgium, ⁽³⁾ SYKE, Finland; ⁽⁴⁾ SMHI, Sweden; ⁽⁵⁾ NIVA, Norway;

⁽⁶⁾ MSI, Estonia; ⁽⁷⁾ HCMR, Greece; ⁽⁸⁾ IFREMER, France, ⁽⁹⁾ IMR, Norway

Abstract

The development and use of FerryBox systems as a cost-effective instrument for continuous observations of the marine environment has been well established since more than 15 years. The systems have evolved to maturity and are since widely used around the coastal ocean of Europe. The availability of newly developed sensors allows the extension of FerryBox measurements to more biogeochemical parameters which are of interest for the requirements of the Marine Strategy Framework Directive (MSFD).

The FerryBox community initially formed from the partners of an EU funded FerryBox project provides mutual exchange of experience and is now organized within EuroGOOS as a so called FerryBox Task Team (www.ferrybox.org). Within the EU funded infrastructure projects JERICO and JERICO-NEXT the technical harmonization as well as the developing of best practise guides for FerryBox systems have been a step further to high quality environmental data products. Within JERICO-NEXT it has been decided to build up a common FerryBox database and data portal in order to make the FerryBox data more available and visible. Furthermore this database will be function as a close link to the Copernicus Marine Environmental Monitoring Services (CMEMS) and the EMODnet portal.

Keywords: FerryBox, EuroGOOS Task Team, ships of opportunity, operational oceanography

1. Introduction

The development and use of FerryBox systems as a cost-effective instrument for continuous observations of the marine environment has been well established since more than 20 years (Petersen 2014). The systems have evolved to maturity and are since widely used around the coastal ocean of Europe. The availability of newly developed sensors allows the extension of FerryBox measurements to more biogeochemical parameters which are of interest for the requirements of the Marine Strategy Framework Directive (MSFD). The FerryBox community initially formed from the partners of an EU funded FerryBox project provides mutual exchange of experience and is now organized within EuroGOOS as a so called FerryBox Task Team (www.ferrybox.org).

This contribution will give an overview about the FerryBox network in Europe including examples of application as well as the status of the European FerryBox database/data portal and the connection to the European Marine data services.

2. Ferrybox Task Team

Since about two years EuroGOOS has organized its activities in working groups and so-called Task Teams (TT). Within this context a FerryBox TT has been established. The TT is responsible for the organisation of the activities of the TT, such as compiling a whitebook on the achievements of the FerryBox community, on the organisation of a recurrent workshop once every 1.5 years to show new applications and technical innovations of FerryBox systems and e.g. collecting data of regular FerryBox routes into an European wide data system, including making data available for all kind of users. Within the TT many activities to extend the possibilities of FB systems to collect other oceanographic parameters as current standard ones like salinity, temperature, turbidity, fluorescence, oxygen, carbon dioxide and dissolved inorganic macronutrients. New sensors are under testing like high precision pH, algal species composition with flowcytometry and molecular analysis. The TT is regularly documenting its activities at the EuroGOOS headquarter and attending meetings with other EuroGOOS TTs.

Within the EU funded infrastructure projects JERICO and JERICO-NEXT the technical harmonization, as well as the developing of best practise guides for FerryBox systems, have been a step further to high quality environmental data products.

Meanwhile FerryBoxes or similar systems are used worldwide. Through the years, some 30 ships are involved in FerryBox monitoring of sea surface parameters. A map of the routes currently operating FerryBoxes in Europe is shown in Fig. 1.

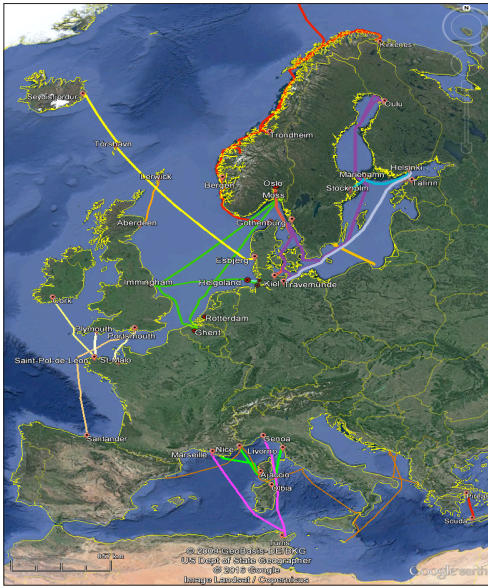

Fig. 1. FerryBox routes from different institutions in Europe in 2016.

3. Ferrybox data base and data portal

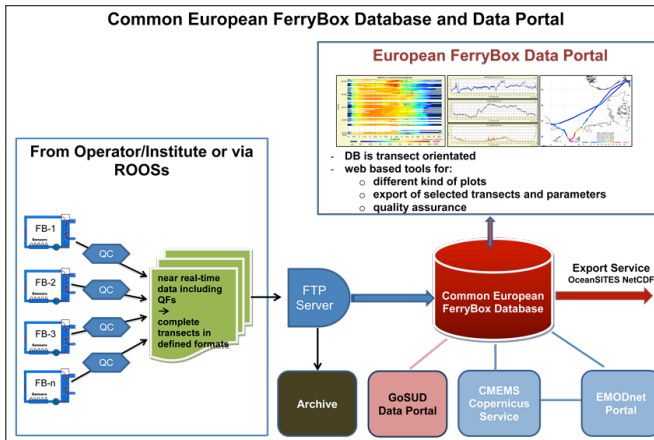

Fig. 2. Schematic diagram of the European FerryBox database and data portal.

During the last FerryBox workshop in 2016 it was decided that a separate European FerryBox portal will be developed, housing a FerryBox database. This portal will provide free access to the highest quality of European FerryBox data, fed directly by FerryBox users in near real-time or in delayed mode, once the data have been processed. Furthermore, this common European FB database of all FerryBox operators will also serve as a showcase for the joint FerryBox activities in Europe and will increase the visibility of the FB community.

Furthermore this database will be function as a close link to the Copernicus Marine Environmental Monitoring Services (CMEMS) and the EMODnet portal. Moreover web-based tools can be used by each FerryBox operator in a similar way to track the activity and the status of his own FerryBox. Fig. 2 shows the proposed design of such a FerryBox data portal and data base.

4. Scientific FerryBox applications

In this chapter a few examples of FerryBox developments and scientific applications are shown.

4.1 Carbon cycle

Knowledge of seasonal and spatial variability in seawater pH is important for several reasons. pH is one of four key measurable variables of the seawater carbonate system. It is closely tied to availability of CO_2 in seawater which is the primary substrate for photosynthesis by marine phytoplankton and macroalgae. pH has also been shown to directly or indirectly affect physiology and development of various marine organisms from bacteria to larval fish, with low pH conditions generally associated with negative effects. The saturation state of aragonite and calcite is pH dependent and this has implications on abiotic carbonate dissolution/formation as well as biomineralization of calcium carbonate by calcifying organisms like coccolithophores, pteropods, bivalves, and corals. Improving our observations and understanding present day spatial and temporal variability in pH variability is critical for detecting long-term changes in pH, such as the projected decrease in ocean pH due to ocean acidification caused by anthropogenic fossil fuel burning which is projected to decrease the pH by $\sim 0.3\text{--}0.4$ by 2100.

NIVA developed an underway spectrophotometric pH sensor (Fig. 3) that pairs with FerryBox systems that can precisely and accurately determine seawater pH under operating conditions to <0.003 pH (Reggiani *et al.* 2016). The Sensor has been applied along the Norwegian coast. The observed seasonal range in pH from $\sim 8.05\text{--}8.30$ (winter to spring/summer) in coastal waters above $\sim 66^\circ\text{N}$ is comparable to the projected average global change due to ocean acidification by year $\sim 2050\text{--}2070$.

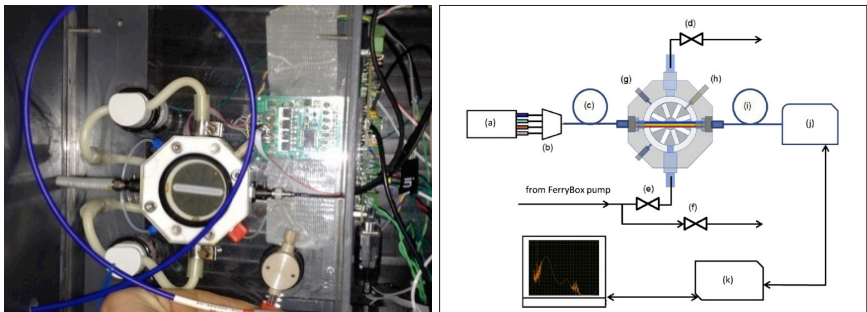

Fig. 3. Automated spectrophotometric high precision pH sensor developed at NIVA for FerryBox applications.

4.2 Phytoplankton Monitoring

Algaline project has been using FerryBox systems on commercial ferries in monitoring the state of the Baltic Sea, and especially to follow the development phytoplankton blooms, since 1993 (Kaitala *et al.* 2014). Phytoplankton abundance is followed using chlorophyll a fluorescence, which is validated using weekly or semiweekly collected discrete samples and analytical laboratory measurements of chlorophyll a concentration. SYKE is currently reviewing different approaches to overcome difficulties in the validation, which arise due to the variability in the chlorophyll a specific fluorescence, i.e. ratio between chlorophyll a fluorescence and concentration.

Spatio-temporal response surfaces, done using kriging methods, are currently explored to minimize prediction errors. In addition they work towards harmonization of primary calibration of field fluorometers, which will provide traceability for fluorescence records.

Phycocyanin fluorometers have been used in the Baltic Sea since 2005 to track the abundance of filamentous cyanobacteria containing occasionally large amounts of this blue-green pigment. Summer blooms occur frequently at different parts of the Baltic Sea, depending on the nutrient status, temperature and mixing conditions. These blooms include often toxic species and they have consequences for biogeochemical cycles as filamentous cyanobacteria species are able to fix atmospheric nitrogen, they may leak fraction of fixed nitrogen to be used by other species and thus causing fertilization of open sea, and they are largely inedible for zooplankton. Phycoerythrin is a red pigment, especially suited for harvesting the green light that penetrates deepest in the Baltic Sea. Phycoerythrin is thus very valuable pigment for species staying at deeper water layers, but frequently observed also throughout the upper water column. Especially Baltic picocyanobacteria, often dominating the phytoplankton community during summer months, are rich of phycoerythrin. Phycoerythrin fluorescence cannot be used, however, as a proxy for picocyanobacteria alone because some other groups (cryptophytes, some dinoflagellates, ciliate *Mesodinium rubrum*) may have high phycoerythrin content as well. Fig. 4 shows as an example of phycocyanin fluorescence as proxy of the filamentous cyanobacteria blooms and phycoerythrin fluorescence as proxy of the picocyanobacteria and sporadic occurrence of other phycoerythrin containing species) along the route Travemuende - Helsinki. The high phycoerythrin fluorescence during spring was mostly related to abundance of *M. rubrum*, while in the summer the values indicate more the distribution of cryptophytes and picocyanobacteria.

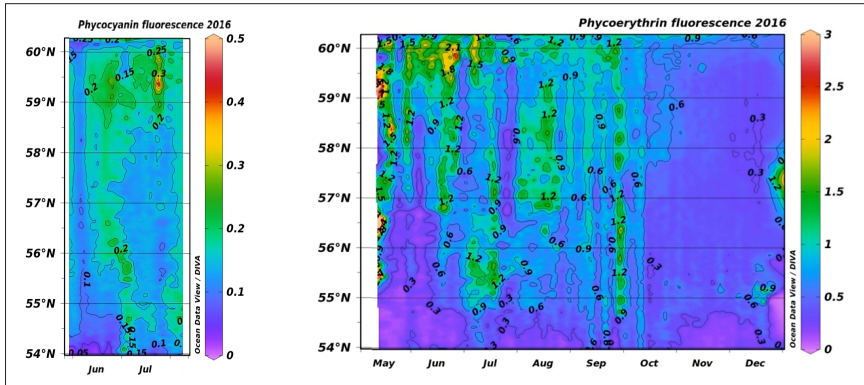

Fig. 4. Phycocyanin fluorescence (left panel) and phycoerythrin fluorescence (right panel) along the route Travemuende - Helsinki.

4.3 Data Assimilation

Operational monitoring and forecasting of marine environmental conditions is a necessary tool for the effective management and protection of the marine ecosystem. It requires the use of multi-variable real-time measurements combined with advanced physical and ecological numerical models. Towards this, a FerryBox system was installed and operated in the route Piraeus–Heraklion. This route is by large traversing the Cretan Sea being the largest and deepest basin (2500 m) in the south Aegean Sea. The analysis of FerryBox SST and SSS *in situ* data revealed the presence of important regional and sub-basin scale physical phenomena, such as wind-driven coastal upwelling and the presence of a mesoscale cyclone to the north of Crete. In order to assess the impact of the FerryBox SST data in constraining the Aegean Sea hydrodynamic model which is part of the POSEIDON forecasting system, the *in situ* data were assimilated using an advanced multivariate assimilation scheme based on the Singular Evolutive Extended Kalman (SEEK) filter, a simplified square-root extended Kalman filter that operates with low-rank error covariance matrices as a way to reduce the computational burden. Thus during the period mid-August 2012–mid January 2013 in addition to the standard assimilating parameters, daily SST data along the ferryboat route from Piraeus to Heraklion were assimilated into the model. Inter-comparisons between the control run of the system (model run that uses only the standard data set of observations) and the experiment where the observational data set is augmented with the FerryBox SST data produce interesting results (Korres *et al.* 2014). Apart from the improvement of the SST error, the additional assimilation of daily of FerryBox SST observations is found to have a significant impact on the correct representation of the dynamical dipole in the central Cretan Sea and other dynamic features of the South Aegean Sea, which is then depicted in the decrease of the basin wide SSH RMS error.

4.4 Integration with other observational platforms

The value of FerryBox data is increased when the FerryBoxes are part of observational networks including other platforms such as moored profilers, gliders, ARGO floats, and research vessel based instruments. For instance, in the stratified Gulf of Finland (Baltic Sea) a FerryBox system on board the Tallinn-Helsinki ferry has been combined with a moored profiler and measurements using a research vessel (see Lips *et al.*, 2016). Simultaneous high-resolution measurements in the surface layer and through the water column allowed to link the horizontal and vertical variability. The results of statistical analysis of FerryBox and Scanfish data suggest that the ageostrophic sub-mesoscale processes (with a spatial scale comparable or less than the internal Rossby radius of deformation which is 2-5km in the Gulf of Finland) could considerably contribute to the energy cascade in this stratified sea basin. Furthermore, a major role of sub-mesoscale processes in feeding surface blooms in the conditions of coupled coastal upwelling and downwelling events in the Gulf of Finland has been suggested (Lips *et al.*, 2016).

Acknowledgements

The FerryBox Task Team thanks EuroGOOS Office for supporting their activities including the print of the white book.

References

- Korres, G.; Ntoumas, M.; Potiris, M.; Petihakis, G. (2014) Assimilating Ferry Box data into the Aegean Sea model. *Journal of Marine Systems* 140, 59–72
- Lips, U., Kikas, V., Liblik, T., Lips, I. (2016). Multi-sensor in situ observations to resolve the sub-mesoscale features in the stratified Gulf of Finland, Baltic Sea. *Ocean Science*, 12 (3), 715–732.10.5194/os-12-715-2016.
- Petersen, W., FerryBox Systems (2014): State-of-the-Art in Europe and Future Development, *Journal of Marine Systems*, DOI: 10.1016/j.jmarsys.2014.07.003
- Reggiani E.R.; King, A.L.; Norli, M.; Jaccard P.; Sørensen, K.; Richard G.J. Bellerby, R.G.J. (2016): FerryBox-assisted monitoring of mixed layer pH in the Norwegian Coastal Current; *Journal of Marine Systems*

CMEMS PRESENT AND FUTURE REQUIREMENTS FOR SATELLITE AND IN SITU OBSERVATIONS

A. Reppucci⁽¹⁾ and P.Y. Le Traon⁽¹⁾

⁽¹⁾ Mercator Ocean, Parc Technologique du Canal 8-10 rue Hermès – Bâtiment C 31520 Ramonville Saint-Agne, France. Antonio.reppucci@mercator-ocean.fr.

Abstract

The Copernicus Marine Environment Service (CMEMS) provides regular and systematic information on the state of the Physical Ocean at global and regional level. The products delivered by the service are used in many domains, from the commercial to the R&D sectors.

Daily operations and evolutions of the service are tightly linked to the supply of upstream data, from the Copernicus space and in situ components, and the proper specification of requirements. This core dependency must be managed strategically to ensure the requirements of the future are in the observing plans of today.

Regular access to Remote Sensing data is managed in collaboration with ESA and EUMETSAT, in charge of the dissemination of Copernicus Satellite data (Core and Contributing missions). CMEMS also provides inputs to the EC on long-term requirements for the Copernicus satellite component (evolution of Sentinels). The access to in situ data is directly managed by CMEMS through its in situ Thematic Assembly Center (TAC). The definition of future in situ requirements and the identification of areas of potential improvements for in situ observing systems relevant to CMEMS is organized by a strong working relationship with EUROGOOS, ROOSEs and the Euro-Argo ERIC. Mercator Ocean is also working on political aspects with the EEA in the framework of the Copernicus in situ component coordination.

All these aspects will be the subject of the present work. Details about present strategy and future requirements will be presented and discussed; main recommendations from CMEMS will be outlined.

Keywords: CMEMS, In situ, Satellite

1. Introduction

The Copernicus Marine Environment Service (CMEMS) provides regular and systematic information on the state of the Physical Ocean at global and regional level. There are four main areas of benefits covered by the service: Maritime Safety, Coastal and Marine Environment, Marine Resources, and Weather, Seasonal Forecasting and Climate activities.

At the moment the service provides, to several thousand of users, pioneering solutions, operational and scientifically assessed, to monitor the global ocean with a focus on the European seas. In agreement with the Delegated Regulation on Copernicus data and information policy, the products delivered by CMEMS are open and free of charge, and compliant with European regulations, such as INSPIRE. The products are accessible through a European one-stop-shop, the CMEMS web-portal, that includes a structured information catalogue monitored to ensure that it complies with its operational obligations to users.

CMEMS is based on a production structure covering two layers (see Fig. 1):

- Processing of space and in situ observations and delivery of derived products: this is achieved through Thematic Assembly Centres (TACs) organized according to consistent parameters – or sets of parameters. CMEMS include three TACs mainly handling space observations (Sea Level, Ocean Colour, Sea Surface Temperature, Sea Ice and Winds) and one TAC dedicated to In situ observations.
- Processing of models, for forecasts, hind-cast and reanalyses, fed by products derived from space and in situ observations (to be provided by the TACs): these tasks are achieved by Monitoring and Forecasting Centres (MFC), structured according to regional domains (6 European regional seas) and global ocean.

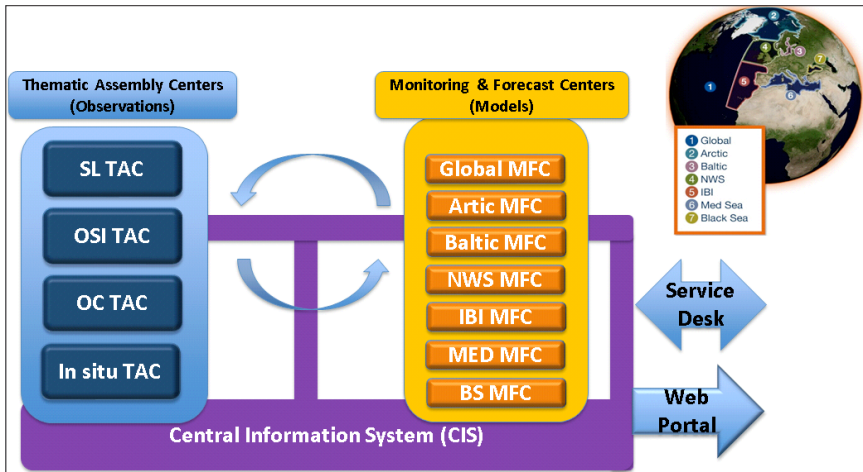

Fig. 1. CMEMS Architecture.

2. CMEMS requirements for the evolution of the Copernicus Satellite Component

Regular access to Remote Sensing data is managed in collaboration with ESA and EUMETSAT, in charge of the dissemination of Copernicus Satellite data (Core and Contributing missions). This is regulated by well-defined operational requirements set to keep the quality of the service to an appropriate level. In this framework the main request are:

- The minimum satellite backbone for global operational SST applications should consist in:
 - An operational polar orbiting satellite system providing high accuracy IR SST measurements, with global coverage on a daily basis;
 - An operational polar orbiting satellite system providing medium accuracy IR SST measurements, with at least four measurements per day at a given location;
 - An operational polar orbiting satellite carrying a large swath microwave imager to provide global all-weather passive microwave (PMW) SST measurements;
 - An operational constellation of geostationary satellites providing medium accuracy IR SST measurements with global coverage (excluding of course Polar Regions), and with at minimum hourly time sampling;

- At least one and preferably two SAR missions in addition to the other non-European missions (e.g. Radarsat) are required for sea-ice monitoring;
- Several publications (Le Traon, 2006; Pascual, 2006) showed that at least 3, but preferably 4, altimetry missions are necessary to retrieve in real time the mesoscale circulation. Thus the multi-mission concept is essential for deriving dense, accurate and reliable sea level measurements for operational oceanography;
- For seas state estimation a minimum of one satellite Altimeter, with global coverage, is sufficient to operate the service; nevertheless, a constellation of four satellites or more is recommended. For SAR instruments a minimum of one satellite between the two composing the Sentinel-1 constellation in 2017 (S1-A and S1-B) is sufficient to operate the service. Global coverage of Wave Mode acquisitions over open ocean regions is mandatory;
- To ensure the production of Ocean Color multi sensor products, data at least from three sensors with global coverage are needed;
- Four scatterometers in orbit are at least required to globally monitor the near surface wind field at high (3-hourly) temporal resolution.

Thanks to the development of the Copernicus satellite component, these requirements are almost completely met, in particular, with Jason-3 (and later on Sentinel 6) for the reference altimeter mission and the two satellite constellations of Sentinel 1 and 3, and through the other European or non-European satellites (e.g. MSG, METOP, AMSR-2, AltiKa, RadarSat, NPP VIIRS).

Requirements for the long term evolution of the Copernicus Satellite Component are regularly gathered and discussed by a dedicated CMEMS scientific and technical committee (STAC) and reported to EC and Space Agencies.

According to the latest analysis done by the CMEMS STAC, CMEMS evolution will be driven by an increasing need for ocean and marine ecosystem monitoring and forecast at fine scale to improve products in coastal areas and to better describe the upper ocean dynamics, in particular ocean currents. Improvements shall also be done in the monitoring and forecasts of the biogeochemical (BGC) state of the ocean (e.g. ocean carbon uptake, acidification, de-oxygenation, eutrophication, water quality, biological productivity). There are also specific requirements for the monitoring of the rapidly changing Polar Regions. The analysis of these needs has led to the formulation of the following requirements for the evolution of the Copernicus Satellite Component:

- Ensure a continuity of the present capability of the Sentinel 1, 3 and 6 missions;
- Develop new capabilities for wide swath altimetry to complement Sentinel 6 and Sentinel 3 altimeter observations;
- Fly a geostationary ocean colour mission over Europe to complement Sentinel 3 observations and strongly improve the time resolution of ocean colour observations over European seas;
- Fly a European microwave mission for high spatial resolution (< 10 km) ocean surface temperature and sea ice concentration;
- Ensure continuity (with improvements) of the Cryosat-2 mission for sea ice thickness monitoring and sea level monitoring in Polar Regions;
- R&D actions should be developed, in parallel, to advance our capabilities to observe sea surface salinities and ocean currents from space;
- Reinforce international coordination to optimize (e.g. orbit phasing) and make the best use of satellite observations from a growing number of space agencies.

Finally, to support the foreseen evolutions of the Copernicus satellite component, dedicated *in situ* activities are needed to ensure the acquisition of the Fiducial Reference Measurements needed for the calibration and validation of satellite sensors and derived products. This will enable the characterization of uncertainties needed for the uptake of all derived products in modelling, assimilative and monitoring activities.

3. CMEMS requirements for the evolution of the Copernicus In situ Component

The main types of *in situ* observing systems aggregated in the dedicated CMEMS TAC, the INS-TAC, and used for constraining the model and for calibration and validation purposes comprise:

- Drifting **Argo Floats** for the measurement of temperature and salinity profiles to ~2000m and, by tracking them, mean subsurface currents;
- **Research vessels** which deliver complete suites of multidisciplinary parameters from the surface to the ocean floor, but with very sparse and intermittent spatial coverage and at very high cost of operations;
- **XBTs** by research vessels and ships of opportunity underway for the measurement of temperature and salinity profiles to ~450-750m depth;

- **Surface Moorings** capable of measuring subsurface temperature profiles in particular continuously over long periods of time. Currents are often monitored and meteorological measurements are usually made too. Biofouling restricts the range of measurements that can be made from long deployments in the photic zone but surface salinity and biogeochemical measurements are attempted;
- **FerryBox** and other regional ship of opportunity measurement programmes for surface transects which may include temperature, salinity, turbidity, chlorophyll, nutrient, oxygen, pH and algal types;
- The network of **tide gauges**, which provides long term reference and validation sea level data.
- **Gliders**, which complement floats and moorings and are able to perform transects of physical and biogeochemical parameters from the surface to 1000m at a lower cost than ships;
- **Surface drifters** are cheap and light-weight platforms that passively follow the horizontal flow at the surface via a drogue/sail. They complement satellites for sea surface temperature and surface current measurements;
- Permanent long-range (up to 200 km) **HF-radar** monitoring systems in specific regions of national/international interests and importance, typically as part of an observatory.

An important contribution to the definition of *in situ* requirements and to the identification of area of potential improvement is ensured by a strong working relationship with EUROGOOS, ROOSses and the Euro-Argo ERIC. Operational aspects of the *in situ* provision are managed in strict collaboration with the CMEMS *In situ* TAC, while the high-level coordination points are coordinated together with the European Environment Agency (EEA).

At the moment there is a quite general consensus about the requirements, and priorities needed to have an *In situ* observing systems which can fulfill CMEMS demands. These have been gathered during several workshops organized between EEA, EuroGOOS, Euro-Argo, Euro-Sites and CMEMS partners. The E-AIMS project has specifically worked on requirements from CMEMS MFCs and TACs. The consolidation and sustainability of the global and regional *in situ* observing systems remain a strong concern. There are critical sustainability gaps and major gaps for biogeochemical observations (carbon, oxygen, nutrients, chl-a). Sustaining the Argo global array, consolidating its regional components and implementing its major extension (BioGeoChemical Argo and Deep Argo) are strong priorities to CMEMS (See E-AIMS project outcomes). Improving ROOSes (Regional Ocean Observing Systems) and key observing systems such as FerryBoxes, gliders, tide gauges and HF Radars is also critical for regional CMEMS products.

These requirements can be summarized as follow:

- In situ measurements are required to validate all variables produced by the models, for assimilation into ocean forecasts and for use in multiyear gridded products (often maps);
- Maintenance of Argo core mission (physical variables) at the present level and increased proportion of biologically equipped Argo profiling floats (Biogeochemical Argo);
- There is the need of a Deep Ocean Observing System, in particular deep Argo floats for all relevant variables with near real-time data delivery where feasible;
- Provision of wave data is required to improve wave and coastal models for both circulation and biogeochemical variables;
- Provision of tidal data, more accurate bathymetric maps, river outflow data (volume, nutrients and sediments);
- Improve the data access to member state coastal in situ observations;
- Extension of relevant in situ time series data to periods exceeding 30 years.

4. CMEMS recommendations

Daily operations and evolutions of the CMEMS service are tightly linked to the supply of upstream data, from the Copernicus space and *in situ* components. These data provide crucial and unique global ocean observations along the water column. Their provision must be managed strategically, along with a targeted update of requirements, to ensure the evolution of the service in response to user needs.

Concerning the Copernicus Space Component, the current space mission succeed to fulfill CMEMS requirement; in the medium to long term it is of paramount importance that continuity is maintained with the upcoming second generation ones . Major evolutions will be linked to an enhancement of the resolution, in space and time, required to monitor and forecast the ocean at fine scale and to improve the monitoring of the coastal zone [CMEMS, 2017]. CMEMS must also improve its capacities to monitor and forecast the biogeochemical (BGC) state of the ocean (e.g. ocean carbon uptake, acidification, de-oxygenation, eutrophication, water quality, biological productivity). Improved CMEMS capacities for biogeochemistry are required for the Marine Strategy Framework Directive (MSFD), to guide decisions and actions by governments and industry and to support knowledge-based management of marine resources (fishery, aquaculture). There are also specific requirements for the monitoring of the rapidly changing Polar Regions [CMEMS, 2017].

The consolidation and sustainability of the global and regional *in situ* observing systems remain a strong concern. There are critical sustainability gaps and major gaps for biogeochemical observations. A source of concern is represented by the lack of adequate funding by Member states to sustain an effective European *In situ* observing system. New mechanisms need to be set up between the EU and member states to address them. Mercator Ocean as the EU delegated body for the Copernicus Marine Service is working with European Environment Agency, Euro-Argo ERIC and EuroGOOS in the framework of the future European Ocean Observing System (EOOS) to consolidate and improve global and regional *in situ* observing systems. Sustaining the Argo global array, consolidating its regional components and implementing its major extension (BioGeoChemical Argo and Deep Argo) are strong priorities to CMEMS. Improving ROOSes (Regional Ocean Observing Systems) and key observing systems such as FerryBoxes, gliders, tide gauges and HF Radars is also critical for regional CMEMS products.

References

CMEMS, (2017). CMEMS requirements for the evolution of the Copernicus Satellite Component. *CMEMS Deliverable*.

CMEMS, (2016). Position paper "Polar and snow cover applications: User Requirements Workshop" *Brussels, 23rd June 2016*.

Le Traon et al., 2016. E-AIMS (Euro-Argo Improvements for the Copernicus Marine Service) FP7 project Final Report. Report available at http://www.euro-argo.eu/content/download/96315/1164689/file/E-AIMS_FinalReport.pdf?version=1

ASSESSMENT OF BALTIC SEA OBSERVATIONS FOR OPERATIONAL OCEANOGRAPHY

J. She

Danish Meteorological Institute, Lyngbyvej 100, DK-2100 Copenhagen Denmark. js@dmi.dk

Abstract

This paper reviews methodology, availability and impacts of Baltic Sea observations on operational oceanography Based on the outcomes of previous and on-going EU projects ODON, ECOOP, OPEC, JERICO and BSCP as well as national projects in BOOS partners. It is found that the in situ profile measurements from R/V monitoring can have large impacts on reducing the model product error on temperature, salinity, chl-a, nutrients and dissolved oxygen. However, most of these profile observations are delivered in a time window longer than one year. It is recommended that ROOSs (Regional Operational Oceanography Systems) shorten the R/V data delivery time window so that they can fit for the purpose of operational production. It is also found that some important monitoring components are missing in the existing OSE/OSSEs. It is recommended that future OSE/OSSEs should be made for integrated network assessment to include observations from ferrybox, Argo, gliders, ADCP, satellite altimetry and ocean colour sensors. More interactions between the sectors of environment protection and operational oceanography are also recommended.

Keywords: observation network assessment, operational oceanography, Baltic Sea

1. Introduction

Ocean observations are generated either from *in situ* or remote sensing monitoring. The purpose of using ocean observations for operational oceanography can be for either R&D, operational production or operational service. Among the use for operational production, data assimilation and product validation are major applications. The former includes on-line validation and regular validation (e.g., quarterly or yearly). For the latter, the observations are assimilated into models either to improve initial field for forecasts or reconstruct the historic fields for reanalysis. In this context, one obvious question is whether the observations are adequate and for the purpose. This covers availability, quality and cost-effectiveness. The availability consists of spatiotemporal resolution, coverage and delivery time window. The quality means the precision of the data. The cost-effectiveness is an indicator for evaluating the quality of a monitoring network. In a general sense, the cost is related to the amount of instruments, cost

for operating the instruments etc. while effectiveness means the impacts of using observations on validation and assimilation. Due to the limit of space, this paper will focus on the assessment of observations in improving the forecast and reconstructing the historic fields in the Baltic Sea. Such kind of assessment is normally based on the use of models. If observations are used to generate the model products, the experiment is called Observing System Experiment (OSE). If only simulated data from a proxy ocean is used, the experiment is Observing System Simulation Experiment (OSSE).

2. Review on methodology

According to the purpose of the OSE/OSSE, they can be divided into three categories: I) OSE/OSSE for identifying the gaps in existing monitoring networks (OSE/OSSE-I); II) OSE/OSSE for assessing impacts of given sampling schemes on ocean field reconstruction and forecasting (OSE/OSSE-II) and iii) OSSE for optimal design of future monitoring networks (OSSE-III).

OSE/OSSE-I: the objective of this type of study is to identify areas that are less or not affected by the given sampling schemes. The key part is to estimate the spatiotemporal impacts of existing observations by using the reanalysis or simulated observations and spatiotemporal correlation fields (She *et al.* 2006, 2007). The spatial distribution of so-called “effective coverage” and “explained variance” can be obtained, which reflects the effectiveness of multiple sampling schemes on resolving the natural variability. For OSSE-I, no data assimilation and field reconstruction works are needed. Hence the experiment can be conducted easily for many different types of sampling schemes. The effective coverage and explained variance of different monitoring networks can be easily compared. The major weakness of this method is that only statistical correlation features are taken into account. Improvements have been made by adding model error and observation error features in the analysis, e.g. the Representer Matrix Spectrum (RMspec) method (Le Hénaff, 2009). This method uses stochastic modelling whereby uncertain inputs are perturbed randomly and $O(10-100)$ ensemble simulations are performed to generate possible model states. Alternatively, Polynomial Chaos (PC) methods explicitly construct the dependence of the model output on the uncertain inputs through a spectral series in the uncertain variables; the series can then be used as a model surrogate and can be mined efficiently for more accurate statistical information (Gelaro & Zhu, 2009).

OSE/OSSE-II: the objective of this type of study is to assess the impacts of using given sampling schemes in improving model analysis and forecast (She *et al.* 2007) or resolving a specific phenomenon, e.g. water transport through straits or the thermocline (Zhang *et al.* 2010, Pantelev *et al.* 2008) etc. In most of the cases, the impacts are evaluated as field reconstruction errors where field reconstruction is performed either through a statistical approach, e.g., optimal interpolation or objective mapping or data

assimilation. The idea is to reconstruct the “true state” from the synthetic data. The classic OSE/OSSE approach is the well-known twin-experiment procedure (Arnold and Dey, 1986), which is a basic method of testing data assimilation schemes developed during the last couple of decades.

OSSE-III: the objective of this type of study is to identify “optimal” future additional sampling scheme in existing observational networks. The classic procedure of optimal network design is, first, to define a cost function as the effectiveness (or error) index of the sampling scheme; second, to find a sampling scheme which can maximize (minimize) the effectiveness (error) index. This will need to explore a large number of options of the sampling scheme. The classic twin-experiment experiments are too heavy to be used for this purpose. Some global or local indexes, such as effective coverage, explained variance (She et al. 2006), sampling error (She, 1996) have been used in optimal design studies. She et al. (2006) developed an optimal network design approach based on simulated annealing for maximizing the explained variance and effective coverage for a given number of buoys. The results show that, by relocating the eight existing buoys at their optimal locations, the explained variance of water temperature is increased from 33% to 56%. Alvarez and Mourre (2012) investigated optimal procedures to sample a given ocean region with a glider in the presence of a mooring in the Ligurian Sea. Pattern Search Optimization (PSO; Hooke and Jeeves 1961) is used to get closer to the optimal solution, searching in a mesh built around a seed point with a given pattern. PSO was found to provide better performance than genetic algorithms and simulated annealing when searching for optimum sampling designs of a glider fleet (Alvarez and Mourre 2014). Some alternative methods are also developed to identify rational sampling for monitoring Targeted Quantities (TQ), e.g., transport through straits, such as Adjoint Sensitivity Analysis (ASA) (Panteleev et al., 2008). The ASA approach estimate impacts (sensitivities) of monitoring variables on the TQ via a spatial distribution map, which clearly identify high sensitivity areas that should be monitored.

3. Review on in situ data availability

For the Baltic Sea, *in situ* ocean observations for operational oceanography include ferrybox lines, moorings, R/Vs (Research Vessels), tidal gauges, Argo and drifter. In recent years HF radars are tested in the transition waters and gliders tested in the central Baltic Sea. The availability and operational use of these data are summarized in Tab. I. To be part of the operational data, it is not necessary to be near real time (NRT). The data are defined as operational either that the data are delivered in NRT or that they are delivered regularly and they fit for the operational time window. HELCOM monitoring data are regarded as operational data due to the fact that they meet the latter conditions. It should be noted that the so-called “operational time window” depends on the users’ operational tasks, which can be very short, e.g., 6 hours for storm surge forecast, or quite long, e.g., Baltic Sea Environment State

Assessment, which is performed once per several years. In Table I., the operational time-window shows 3 values which correspond to data assimilation in forecast (FC), rapid environment assessment (REA) and reanalysis (RAN), respectively. The REA means hindcast or reanalysis of the environmental status for the past quarter(s). The number of stations shown in Table I. is based on BOOS and EMODnet-Physics for the NRT observations. Table I shows that only NRT T/S and part of the SST data have been used for forecast production. R/V HELCOM data can be used for FC and REA if they can be delivered within the operational time windows, i.e., 3 weeks and 3 months. All NRT data can be used for environmental assessment, nevertheless this is not the case for the time being.



Table I. Availability of Baltic Sea in situ observations to operational oceanography. SST: Sea Surface Temperature; SSS: Sea Surface Salinity; SSC: Sea Surface Currents; DO: Dissolved Oxygen; NRT: near real time; Val.: Validation; FC: forecast; RAN: Reanalysis

INSTRUMENTS	VARIABLES	AMOUNT*	DELIVERY TIME	OPRATIONAL TIME WINDOW	EXISTING OPERATIONAL USE
Tidal gauges	Water level	148/169	1-10min.	6H/3M/1Y	Val.
	SST	24/27		1D/3M/1Y	Val.
Moorings	Waves	12/21	<1hour	6H/3M/1Y	Val.
	SST	26/49		1D/3M/1Y	Val., RAN
	T/S	8/19		3W/3M/1Y	FC, RAN
	Currents	7/17		6H/3M/1Y	None
	Chl-a	3/3		1D/3M/1Y	None
	DO	3/3		1D/3M/1Y	None
Ferrybox	SST	15/30	NRT	1D/3M/1Y	Val.
	SSS	4/19		1D/3M/1Y	Val.
	Surf-DO	3/17		1D/3M/1Y	None
	Surf-Chl-a	3/17		1D/3M/1Y	None
	SSC	11/11		6H/3M/1Y	None
Drifter	SST	0/5	NRT	1D/3M/1Y	None
Argo	T/S	0/10	NRT	3W/3M/1Y	None
Profiler	T/S	0/1	NRT	3W/3M/1Y	None
R/V BOOS	T/S	109	NRT	3W/3M/1Y	Val. FC, RAN
R/V HELCOM	T/S	834/797	>1yr	3W/3M/1Y	Val. Assessment
	Chl-a	755		?/3M/1Y	Assessment
	DO	792		?/3M/1Y	RAN, assessment
	Secchi Dep.	702		?/3M/1Y	Assessment
	PH	409		?/3M/1Y	Assessment
	N/P/Si	548/549/501		?/3M/1Y	RAN, assessment
	Phytoplankton	257		?/3M/1Y	Assessment
	Zooplankton	141		?/3M/1Y	
	Primary prod.	27		?/3M/1Y	

*Amount of observations: I) for NRT observations, number of stations is given for the past 7days/10years; II) for R/V HELCOM, number of stations or profiles in 2013 is given. "?" means unknown.

4. Review on OSEs and OSSEs

For the Baltic Sea, existing OSE and OSSE research have mainly been type-I and type-II studies, funded by EC projects ODON, ECOOP, JERICO and OPEC etc. In terms of spatiotemporal coverage, the NRT data have high resolution but gaps in the open waters for profile measurements. HELCOM environment monitoring data, on the other hand, are widely distributed in open waters but has a lower resolution.

4.1 Gap analysis (OSE/OSSE-I)

In the Baltic Sea, OSE/OSSE-I type of studies has been carried out to identify the effectiveness of existing SST and T/S observational networks in ODON project (She *et al.*, 2006) and ECOOP (Fu *et al.* 2011), and for biogeochemical observational networks in OPEC (She *et al.*, 2014) and BSCP project (She *et al.*, 2016)¹.

Oceanography: The ODON project developed two indicators, effective coverage and explained variance, based on the covariance structure of a proxy ocean (She *et al.*, 2007). With three NOAA (National Ocean and Atmosphere Administration) SST sensors, the mean effective coverage of SST reaches 31% for the Baltic-North Sea. However, the effective coverage rate of the satellite and in situ sampling schemes show almost no changes.

Biogeochemical monitoring: as shown in Tab. I, the regular Baltic Sea biogeochemical monitoring network includes HELCOM monitoring network (R/V), moored buoy array and network of the ferrybox lines. In the OPEC project, a gap analysis was conducted on the monitoring networks of chl-a and nutrients for the purpose of operational ecology (She *et al.*, 2014). In BSCP project, a gap analysis was made on the HELCOM biogeochemical monitoring for the eutrophication assessment. Major conclusion is that 20-50% of the sub-basins are under-sampled for eutrophication assessment. For operational ecology, major bottle-neck is the too long delivery time of the data (She *et al.*, 2016)¹. It is recommended that an integrated use of in situ (incl. both BOOS NRT and HELCOM) observations, satellite observations and models should be developed both for operational ecology and environment assessment.

4.2 Impact analysis (OSE/OSSE-II)

The impacts of the existing Baltic monitoring network on forecast and reanalysis have been studied in many papers. Table II listed a few OSE and OSSE studies and their major outcomes, covering impacts of SST, T/S, water level and biogeochemical observations. There is still a lack of OSE and OSSEs on ferrybox observations and Argo floats. In general the number of OSSEs is significantly less than that of the OSEs. All OSEs show that in situ observations have significant impact in reducing model errors, both for physical and biogeochemical variables. The data delivery time window for T/S is identified as about 3 weeks (Zhuang *et al.*, 2011). OSSE on gliders show that the impact of observations relies on largely model error features (Wan, 2014)³. A glider route from Gdansk to Northern Baltic Proper significantly reduces the model's RMSE on salinity as this route is featured by the model's high salinity error in the Baltic Sea.

Table II. Impact studies of Baltic Sea observations based on OSEs and OSSEs

OSSES/OSSES	MONITORING NETWORK	MAJOR OUTCOMES
She <i>et al.</i> (2007)	SST from NOAA satellites and in situ	RMSE is reduced by 43%; satellites have much larger impacts than in situ data
Fu <i>et al.</i> (2012)	ICES T/S (20 years)	Below 60m, RMSE of T is reduced by 35%, mean bias of S by 80%, RMSE by 52%
Zhuang <i>et al.</i> (2011)	ICES T/S	Impact time of T/S assimilation is about 3 weeks
Fu (2016)	ICES T/S (10 years)	Mean bias of SST, T, S, and mixed layer depth is decreased by 57%, 49%, 43% and 43%; for Chl-a, DIN and DIP 15.5%, 9%, and 23%.
Liu <i>et al.</i> (2016)	Baltic T/S/N/P, oxygen, ammonium (30 years) from SHARK database	RMSD is reduced by 59%, 46%, 78% and 45% for oxygen, nitrate, phosphate and ammonium.
Wan (2014)	2 T/S sections (Route 1 and Route) of two gliders, (OSSE)	Mean deviations is reduced by 6.6%, 2.3%, 13% for T and 3.8%, 27%, 30% for S for Route 1, Route 2 and Route 1+2
Madsen <i>et al.</i> (2015)	Tidal gauges and altimetry	RMS error is reduced by 35%

5. Recommendations

In this paper, existing studies on assessing the Baltic Sea observations – the methodology, data availability and impact of the observations, are reviewed. It is found that the *in situ* profile measurements from R/V monitoring can have large impacts on reducing the model product error on temperature, salinity, chl-a, nutrients and dissolved oxygen. However, most of these profile observations are delivered in a delayed time window longer than one year. Although this still fits current environment assessment framework, for most of the operational tasks, e.g., forecast, rapid environment assessment and ocean state report in CMEMS, it is too late. It is recommended that ROOSs (Regional Operational Oceanography Systems) shorten the R/V data delivery time window so that they can fit for the purpose of operational production. It is also found that existing OSE/OSSEs still miss some important monitoring components, e.g., Ferrybox, Argo, gliders, ADCP, satellite altimetry and ocean colour sensors etc. It is recommended that integrated network assessment to include observations from both satellite and *in situ* instruments which already have capacities on operational data delivery. Interaction between BOOS and HELCOM monitoring networks should be strengthened so that the sectors of environment protection and operational oceanography can benefit each other.

¹ http://www.emodnet-baltic.eu/Portals/0/DAR/BSCP_DAR1_Version_20161202.pdf

² <https://www.smhi.se/klimatdata/oceanografi/havsmiljodata>

³ http://www.jerico-ri.eu/download/filebase/jerico_fp7/deliverables/D9.6_WP9_OSSE_Final_Report.pdf

References

Alvarez A. and Mourre, B. (2012), Optimum sampling designs for a glider-mooring observing network, *J. Atmos. Ocean. Tech.*, 4,601-613.

Alvarez A and Mourre B. (2014). Cooperation or coordination of underwater glider networks? An assessment from Observing System Simulation Experiments in the Ligurian Sea, *J. Atmos. Ocean. Tech.*, 31(10), 2268-2277.

Arnold, C.P., Jr., and Dey C.H. (1986): Observing-systems simulation experiments: Past, present, and future. *Bull. Amer. Meteor. Soc.*, 67, 687–695.

Fu, W., Høyer, J. L., and She J. (2011). Assessment of the three-dimensional temperature and salinity observational networks in the Baltic Sea and North Sea, *Ocean Sci.*, 7, 75-90

Fu, W., She J., and Dobrynin, M. (2012): A 20-year reanalysis experiment in the Baltic Sea using three-dimensional variational (3DVAR) method. *Ocean Sci.*, 8(5), 827–844.

Fu, W. (2016): On the role of temperature and salinity data assimilation to constrain a coupled physical-biogeochemical model in the Baltic Sea. *J. Phys. Oceanogr.*, 46, 713–729.

Gelaro R and Zhu Y. (2009). Examination of observation impacts derives from Observing System Experiments (OSEs) and adjoint models. *Tellus*. 61A:179–193.

Hooke, R., and T. A. Jeeves (1961): Direct search solution of numerical and statistical problems. *J. Assoc. Comp. Mach.*, 8, 212–229.

Le Hénaff M., De Mey P. and Marsaleix P. (2009). Assessment of observational networks with the Representer Matrix Spectra method—application to a 3D coastal model of the Bay of Biscay. *Ocean Dyn.* 59(1):3–20.

Liu, Y., Meier, H. E. M., and Eilola, K. (2017): Nutrient transports in the Baltic Sea – results from a 30-year physical–biogeochemical reanalysis, *Biogeosciences*, 14, 2113-2131

Madsen, K.S., Høyer J.L., Fu W. and Donlon C. (2015), Blending of satellite and tide gauge sea level observations and its assimilation in a storm surge model of the North Sea and Baltic Sea, *J. Geophys. Res. Oceans*, 120, 6405–6418

Panteleev, G.G, Yaremchuk M. and Nechaev D. (2008). Optimization of mooring observations in Northern Bering Sea. *Dynamics of Atmospheres and Oceans*, doi:10.1016/j.physletb.2003.10.071.

She, J., I. Allen, S. S. Arkin, M. Butenschon, S. Ciavatta, W. Fu, S. Kay, G. Petihakis, B. Salihoglu, C. Solidoro, G. Triantafyllou and K. Tsiaras (2014). Effectiveness of routine monitoring of ecosystem properties in European regional seas. *OPEC Report*, D5.2

She, J., B. Armstrup, K. Borenas, E. Buch, L. Funkquist, P. Luyten and R. Proctor (2006). ODON: Optimal Design of Observational Networks, *ODON Final Report*.

She J., Jacob L. Høyer, and Jesper Larsen (2007). Assessment of sea surface temperature observational networks in the Baltic Sea and North Sea. *J. Mar. Sys.* 65, 314-335.

She J. (1996). Optimal Evaluation and design study for upper ocean observing system. Japan Marine Science and Technology Center (JAMSTEC) *Tech. Rep.*, pp70.

Zhang S., A. Rosati and T. Delworth (2010). The Adequacy of Observing Systems in Monitoring the Atlantic Meridional Overturning Circulation and North Atlantic Climate. *J Clim* 23:5311–5324.

Zhuang, S. W. Fu, and J. She (2011). A pre-operational 3-D variational data assimilation system in the North/Baltic Sea, *Ocean Sci.*, 7, 771-781.

NEW SOURCES OF IN SITU MARINE DATA TO SUPPORT EC MARINE STRATEGY FRAMEWORK DIRECTIVE IMPLEMENTATION IN THE BLACK SEA

A. Palazov⁽¹⁾, V. Slabakova⁽²⁾ and V. Marinova⁽³⁾

⁽¹⁾ Institute of Oceanology – BAS, Varna, Bulgaria, palazov@io-bas.bg

⁽²⁾ Institute of Oceanology – BAS, Varna, Bulgaria, v.slabakova@io-bas.bg

⁽³⁾ Institute of Oceanology – BAS, Varna, Bulgaria, marinova@io-bas.bg

Abstract

Maintaining good environmental status of marine and inland waters is essential for Bulgaria. It will ensure that the resources of the ecosystems are maintained along with the economic and social benefits deriving from them. Initial assessment of ecological state of Bulgarian marine waters showed lack of data for some descriptors of Marine Strategy Framework Directive (MSFD). Knowing this Bulgarian government established programme BG02 INTEGRATED MARINE AND INLAND WATER MANAGEMENT, managed by Bulgarian Ministry of environment and waters and co-financed by the Financial Mechanism of the European Economic Area (EEA FM) 2009 – 2014. The main goal is to build up tools for assessment of marine environment by implementing new technologies and best practices for addressing main areas of interest with lack of marine data. The main outcomes of the programme are to fill the gaps in information from the Initial assessment of the marine environment and to collect data to assess the current ecological status of marine waters including information as a base for revision of ecological targets established by the monitoring programme prepared in 2014 under MSFD. Project results supported implementation of MSFD in Bulgarian marine waters for the benefit of coastal population, marine industry, tourism, marine research and marine spatial planning.

Keywords: marine monitoring, real time data, MSFD

1. Introduction

The programme BG02 INTEGRATED MARINE AND INLAND WATER MANAGEMENT, managed by Bulgarian Ministry of environment and waters and co-financed by the Financial Mechanism of the European Economic Area (EEA FM) 2009 – 2014 is targeted to fulfill the lack of data for some descriptors of MSFD which became obvious after initial assessment of ecological state of Bulgarian marine waters. Two of the projects supported under the programme (IMAMO and MARLEN) were dedicated to the improvement of the monitoring capacity and expertise of the organizations responsible for marine waters monitoring in Bulgaria to meet the requirements of EU and national legislation. The main goals are to establish a real time monitoring and to build up tools for assessment of marine environment by implementing new technologies and best practices for addressing three main areas of interest with lack of marine data in particular: a) Marine litter detection and classification in coastal areas; b) Regular near real time surface water eutrophication monitoring on large aquatic area ; c) Underwater noise monitoring. The main outcomes of the projects are to fill the gaps in information from the Initial assessment of the marine environment and to collect data to assess the current ecological status of marine waters including information as a base for revision of ecological targets established by the monitoring programme prepared in 2014 under Art. 11 of MSFD. Developed tools are an important source of real time, near real time and delay mode marine data for Bulgarian Black Sea waters. Project results supported implementation of MSFD in Bulgarian marine waters for the benefit of coastal population, marine industry, tourism, marine research and marine spatial planning.

2. Imamo project

The beneficiary of IMAMO - Improved Marine Waters Monitoring project is the Institute of oceanology – Bulgarian Academy of Sciences with two partners: Norwegian Institute for Water Research and Bulgarian Black Sea Basin Directorate. The Project aims to improve the monitoring capacity and expertise of the organizations responsible for marine waters monitoring in Bulgaria to meet the requirements of EU and national legislation. Project activities are targeted to ensure data for Descriptors 5 - Eutrophication, 8 - Contaminants and 9 - Contaminants in fish and other seafood. IMAMO aims to increase the institutional capacity of the Bulgarian partners related to the monitoring and assessment of the Black Sea environment. The main outputs are: establishment of real time monitoring and set up of accredited laboratory facilities for marine waters and sediments chemical analysis as well as to collect environmental data to ensure the ability of Bulgarian partners to monitor progress of subsequent measures undertaken.

From May 2015 to April 2016 twelve cruises with the research vessel „Akademik“ were performed monthly. During the cruises 200 water samples, 8 sediment samples and 16 biota samples were collected. Samples were analysed for priority substances and specific pollutants in marine waters, bottom sediments and biota. The chemical laboratory was prepared in accordance with EU standards and equipment requirements. Analytical instruments were delivered and installed. IO-BAS lab experts were trained in NIVA to work with analytical instruments. Five analytical methods were introduced. Accreditation documents were prepared according to the ISO 17025 standard. Interlaboratory comparison exercise was performed.

A system for real time monitoring was developed consists of two moorings and four coastal stations (Palazov *et al.*, 2017). Surface buoys and bottom stations were deployed in Burgas and Varna bays (Fig. 1). Coastal stations are located in Balchik, Shkorpilovtci, Pomorie and Cape maslen. Several marine variables are provided by two moorings in real time: Wind speed and direction, Air Temperature, Atmospheric pressure, Relative humidity, Turbidity, Conductivity, Dissolved oxygen, Chlorophyll, Dissolved organic matter (CDOM), Sea water temperature, Currents speed and direction, Significant wave height and Wave period. Coastal stations provide Sea water temperature and Salinity and Sea level. Some of them have also weather stations. All data are transmitted in real time to the National oceanographic data center, stored in database and published on the web.

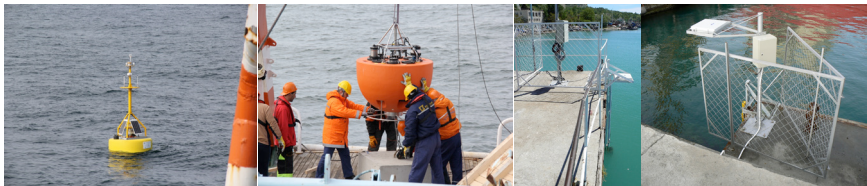

Fig. 1. Moored buoys and coastal stations along Bulgarian Black Sea coast.

The maintenance is one of the biggest problems for *in situ* marine systems. Due to intensive bio-fouling in the Black Sea especially during spring and summer seasons optical sensors become unusable after a few months - Fig. 2.



Fig. 2. Bio-fouling of *in situ* sensors after three months.

To keep the systems operational cleaning should be repeated every one to three months depend of the season. The most sensitive are optical sensors which windows could be damaged due to intensive bio-fouling if not cleaned for long period.

3. Marlen project

The beneficiary of MARLEN - Marine Litter, Eutrophication and Noise Assessment Tools is the Institute of Oceanology – Bulgarian Academy of Sciences with two partners: Burgas municipality and Bulgarian Black Sea Basin Directorate. Initial assessment of environmental state of Bulgarian marine waters showed lack of data for some descriptors of MSFD. The main goal of MARLEN is to build up tools for assessment of marine environment by implementing new technologies and best practices for addressing three main areas of interest with lack of marine data in particular: a) Marine litter detection and classification in coastal areas; b) Regular near real time surface water eutrophication monitoring on large aquatory; c) Underwater noise monitoring. Developed tools are an important source of real time, near real time and delay mode marine data for Bulgarian Black Sea waters. The partnership within the project increased capacity for environmental assessments and training of personnel and enhances collaboration between scientific institutes, regional and local authorities. Project results supported implementation of MSFD in Bulgarian marine waters for the benefit of coastal population, marine industry, tourism, marine research and marine spatial planning.

3.1 Marine litter (ML) classification in the coastal areas

A pilot monitoring of ML has been carried out in 11 unsecured beaches with limited or no access along the Bulgarian Black Sea coast (Fig. 3) base on images taken by unmanned aerial vehicle (UAV). The objectives of this preliminary study were to: i) to develop methodology for remote sensing observation of marine macro litter; ii) to assess the abundance, composition, size classes and special distribution of beach litter (> 2,5 cm) according to the MFSD requirements based on the data obtained from unmanned aerial system ; 2) to assess the efficiency and cost-effectiveness of new technologies to provide quick, accurate and quantitative assessments of the marine litter distribution.

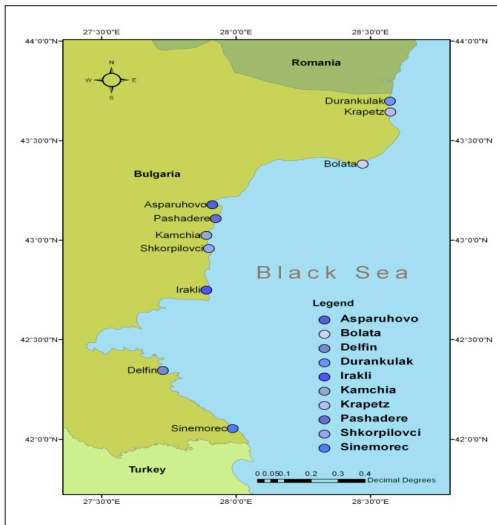

Fig. 3. Distribution of survey beaches.

The pilot surveys were carried out using aerial images collected by a Vertical Takeoff/Landing platform, model DJI Phantom 4 Pro in the period 8-28 March 2017. The identical UAV mission parameters were applied for monitoring of beach litter in all selected sites. Processing of aerial images was carried out using Computer Vision (CV) algorithm of the Pix4D photogrammetric software that allows to process a large amount of images in a fast and easy way, with limited influence of the user on the resulting orthophoto mosaics.

Marine litter item classification was done according to the TGML Master List of categories (Galgani *et al.* 2013). The items were classified into the following categories: artificial polymer materials, rubber, cloth/textile, paper/cardboard, processed/worked wood, metal, glass/ceramics and unidentified with a total 153 subcategories. A classification into different size classes was completed into seven clusters: < 2.5cm; 2.5cm; 5-10cm; 10-20cm; 20-30cm; 30-50cm; >50cm. The ML density was determined as number of the items per m².

In total of 1319 ML items of varying sizes were observed in 11 monitoring sites along the Bulgarian Black Sea coast. The data analysis revealed that plastic constituted 90% of the total litter (Fig. 4).

Results were verified by comparison with a measurement done by manual litter pick up. The *in situ* collection of ML returned a difference of 10% due to semi-transparent plastic objects hardly recognizable by drone images.

3.2 Regular monitoring in near real time of the eutrophication of the marine surface waters

Anderaa version of Ferrybox named SOOGuard has been installed on four voluntary vessels for monitoring of the eutrophication of the Black Sea surface waters. The parameters measured by each system are conductivity, temperature, dissolved oxygen, chlorophyll and turbidity. The data is transmitted in real or near real time via GPRS communication. The FerryBox data are stored in the data base and can be accessed via internet (<http://eugrant.io-bas.bg/>). From the database different vizualizaton tools for the FerryBox data are available.

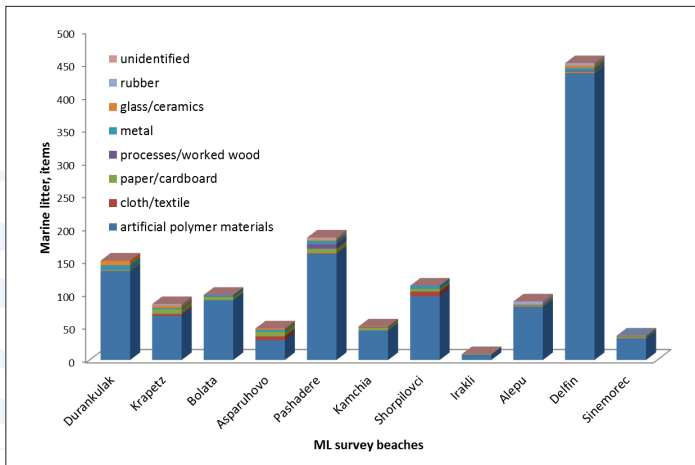

Fig. 4. Proportion of marine litter items by material on the Bulgarian Black Sea coast by count.

The estimated ML density (mean \pm SD) from combined data was $0,08 \pm 0,007$ (item/m²) as highest value was seen at "Delfin" beach ($0,30$ items/m²) situated in the southern part of the Bulgarian Black Sea coast. Another parameter that was investigated was the variation of size distribution among the different marine litter items. The majority (82%) of the ML belonged to the size classes "A" and "B" (Fig. 5).

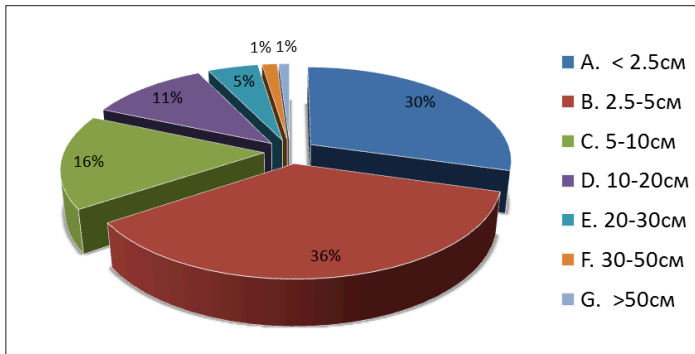

Fig. 5. Percentage contribution of the various size classes in beach litter.

3.3 Passive acoustic monitoring (PAM) of the underwater noise

Measurements are carried out with stationary hydrophone systems located in three near coastal areas with different anthropogenic activity. Monitoring process covers both time wise and space wise distribution of the amplitudes and the frequencies of natural and anthropogenic noises in the marine environment.

4. Conclusions

A real-time monitoring system has been set up for the main physicochemical and biological parameters of the sea water on the Bulgarian Black Sea coast, which increases the volume of the collected monitoring data on a significant scale and significantly improves the spatial and temporal characteristics of the monitoring process while attaining much better traceability of the phenomena and processes in the Bulgarian Black Sea waters.

An efficient system for regular monitoring of surface water eutrophication in large aquatic environments has been established using oceanographic instruments for monitoring the surface waters of the Black Sea, installed on volunteer ships and collecting data during their voyage.

Using stationary instruments with broadband hydrophones for passive acoustic monitoring, data on underwater noise was collected to initiate a regular process to fill the lack of data on noise in the marine environment necessary to assess the ecological status of marine waters in implementation of The Marine Strategy Framework Directive of the European Union.

An innovative technology has been implemented using unmanned aerial vehicle for marine litter monitoring on the beaches and the sea surface, with the help of which large and otherwise difficult accessible areas can be observed.

Marine litter data in pilot beaches, seabed and sea surface were collected, partially completing the lack of marine litter data needed to assess the ecological status, prepare the monitoring plans and the program of measures to achieve good environmental status of marine waters in implementation of the EU Marine Strategy Framework Directive.

The capacity to assess the status of the marine environment has been enhanced, the technical staff involved in monitoring activities have been qualified and cooperation between research institutes, national and regional authorities as well as international cooperation in the field of monitoring of marine waters was improved.

Acknowledgements

This document was created with the financial support of BG02 “Integrated Marine and Inland Water Management” Program, managed by Bulgarian Ministry of environment and waters and co-financed by the Financial Mechanism of the European Economic Area (EEA FM) 2009 – 2014 through two projects: IMAMO - Improved Marine Waters Monitoring (call BG02.02: Improved Monitoring of Marine Waters) and MARLEN - Marine Litter, Eutrophication and Noise Assessment Tools (call BG02.03: Increased capacity for assessing and predicting environmental status in marine and inland waters).

References

- Palazov A., Yakushev E., Milkova T., Slabakova V., and Hristova O. (2017). Improved Marine Waters Monitoring, *Geophysical Research Abstracts*, Vol. 19, EGU2017-10579, 2017, EGU General Assembly 2017
- Palazov A., Velcheva M., Milkova T., Slabakova V., and Marinova V. (2017). Marine Litter, Eutrophication and Noise Assessment Tools, *Geophysical Research Abstracts*, Vol. 19, EGU2017-10712, 2017, EGU General Assembly 2017.
- MSFD GES Technical Subgroup on Marine Litter (TSG-ML), 2013. Monitoring Guidance for Marine Litter in European Seas. *DRAFT REPORT*, July 2013.

NOVEL, MULTI-PLATFORM ACOUSTIC AND OPTICAL SENSORS AND DATA SERVICES DEVELOPED IN THE NEXOS PROJECT

L. Golmen⁽¹⁾, E. Delory⁽²⁾, O. Zielinski⁽³⁾, J. del Rio⁽⁴⁾, K. Kvalsund⁽⁵⁾, J. Pearlman⁽⁶⁾,
L. de Swart⁽⁷⁾, L. Delauney⁽⁸⁾, M. Rieke⁽⁹⁾ and S. Østerhus⁽¹⁰⁾

⁽¹⁾ Norwegian Institute for Water Research, NIVA, Bergen, Norway, Lars.golmen@niva.no

⁽²⁾ Plataforma Oceánica de Canarias, PLOCAN, Telde, Spain

⁽³⁾ Carl von Ossietzky Universität, UNOL, Oldenburg, Germany

⁽⁴⁾ Universitat Politècnica de Catalunya, UPC, Barcelona, Spain

⁽⁵⁾ Runde environmental centre, REC, Runde, Norway

⁽⁶⁾ IEEE, Seattle, WA, USA

⁽⁷⁾ ECORYS, Rotterdam, Netherlands

⁽⁸⁾ IFREMER, Brest, France

⁽⁹⁾ 52°North, Münster, Germany

⁽¹⁰⁾ UNI Research, Bergen, Norway

Abstract

The European Union FP7 project “Next generation, Cost- effective, Compact, Multifunctional Web Enabled Ocean Sensor Systems Empowering Marine, Maritime and Fisheries Management” (NeXOS, 2013-2017) focused on innovative approaches for two classes of insitu observations, acoustic and optical. Two types of innovative passive acoustic sensors were developed - one having a single detector with increased dynamic range and internal processing to reduce communication requirements and the other having an array of four such sensors providing directional capabilities. The optical sensors developed were Matrix fluorescence sensors, a minifluo fluorescence sensor, flow-through cavity absorption sensors, and sensors for monitoring the carbon system. Additionally, optical sensors for chlorophyll-a and dissolved oxygen were adapted for use in fisheries. The sensors were modified to enable plug-and-play capabilities on the basis of the Open Geospatial Consortium (OGC) PUCK protocol embedded in the internal software of the sensor. This protocol ensures that measured data are accompanied by metadata describing the sensor and its history. The OGC Sensor Web Enablement (SWE) and the Sensor Observation Service (SOS) web server make data from the NeXOS sensors available in real-time to the end-users. The final demonstrations took place during summer of 2017 in the Northeast Atlantic, Central Atlantic and the Mediterranean. This manuscript presents the main outcomes of the project.

Keywords: Optical sensor, acoustic sensor, SEISI, Sensor web enablement, NeXOS

1. Introduction

Two main sensing techniques were implemented in the European Union FP7 project “Next generation, Cost- effective, Compact, Multifunctional Web Enabled Ocean Sensor Systems Empowering Marine, Maritime and Fisheries Management” (NeXOS, 2013-2017), reported on here. The aims of the NeXOS project were to provide innovative and practical solutions to some of the challenges of comprehensive ocean observations such as the need to reduce power requirements, reduce data communication bandwidth requirements, introduce new frameworks for interoperability and provide operators and users with improved information.

NeXOS developed two types of innovative sensors – based on optical and acoustic measurement principles, respectively. See Table I for an overview. The optical sensors were of three types: Matrix fluorescence, *in situ* sensors (O_1), Flow-through cavity absorption sensors (O_2), and sensors for monitoring the carbon cycle (O_3), (Pearlman and Zielinski 2017). One series of O_1 sensors applied the distinct wavelengths combination for excitation and emission to measure in a Matrix Configuration. The second series were for measurements by two single optical channels using ultraviolet light range for excitation. The target parameters included fluorescent dissolved organic matter (FDOM) peaks, Chlorophyll-a, Naphthalene, Phenanthrene and Fluorene. The O_2 type flow-through sensors were the semi-automated PSICAM and the fully automated and compact HyAbSv/2, and the flow-through and submersible OSCAR-G2. The O_3 sensors were different combinations for measuring the carbon system parameters pCO_2 , pH and total alkalinity in a flow-through setup.

Two compact, passive acoustic sensors were developed, A1 having a single detector with increased dynamic range and A2, an array of such sensors providing directional capabilities (Delory *et al.* 2014). A2 is a series of individual volumetric hydrophones, enabling real-time measurement of underwater noise and of several soundscape sources, consisting of an array of 4 digital hydrophones with Ethernet interface and a master unit for data processing. Besides this, an antifouling system was developed to fit a type of optical sensor, also adaptive to underwater cameras (Delauney *et al.* 2015). With respect to fisheries management, new, very sturdy, small size and very-low cost sensors were developed specifically for fishing vessels. These are chlorophyll and oxygen sensors for installation on fishing nets. The sensors are defined as an EAF sensor system (Ecosystem Approach to Fisheries).

Table I. Sensors developed in the NeXOS project, with some target platforms.

SENSOR TECHNOLOGY		SENCOR TYPE	
Optical		01 Matrix-fluorescence	
		02 Hyperspectral	
		03 Carbon	
Passive Acoustics		A1 Preprocessed	
		A2 Real-time	
RECOPECA/EAF		EAF/Chlorophyll	
		EAF/Oxygen	
CROSS CUTTING TECHNOLOGIES			
Smart Sensor Interface – OGC PUCK + SWE		Bio-fouling prevention	
TARGET PLATFORMS			
Gliders	Drifters/profilers	Cable Observatories	Ferries
Trawlers	Nets & Lines	Other leisure	Stand alone

All developments in NeXOS followed these requirements: High reliability; High resolution of measurements; Robustness; Low energy consumption; Reduced size and Affordable cost. The selected platforms for demonstrating the sensors were gliders, voluntary observing ships (FerryBox), a seafloor cabled observatory, an autonomous surface vessel (Sailbuoy) and fishing vessels.

In the integration work, the sensors were modified to enable plug-and-play capabilities based on the Open Geospatial Consortium (OGC) PUCK protocol embedded in the internal software. This protocol ensures that measured data are accompanied by metadata describing the sensor and its history. The OGC Sensor Web Enablement (SWE) and the Sensor Observation Service (SOS) web server make data from the NeXOS sensors available in real-time by the end-users.

1.1 Market and TRL study

Manufacturing of sensors for operational use is governed in part by maturity of the sensor and its technology. This is indicated by the technology readiness of the sensors according to a scale “Technological readiness level” (TRL; Sadin 1989) which assigns a level of 6-7 for sensors demonstrated in development, 8 for sensors demonstrated in prototype operations and 9 for operational systems. NeXOS did an assessment of TRL for its sensors. The levels ranged from 2-5 at the beginning of developments, with level 7-8 at the end of the project. This means close to market, but still with some issues to be resolved. The main focus of the NeXOS market study was to assess the market for optical sensors, passive acoustic sensors and the Ecosystem Approach to Fisheries (EAF) sensor system. The value chain of the market was drawn to depict the distinct activities that add value to science and maritime observation activities. The activities on the main branch of the value chain include sensor manufacturing, sensor developing and integrating into platforms as well as adapting the sensors to the needs of the observations, operating them, analyzing the collected data and exploiting the results of the observations.

The main and most promising market segments for marine sensor activities were identified with 3 perspectives of sensor use that actually drive the user requirements for sensors. These perspectives are: i) research, ii) industry and iii) research and development. The growth expectations were examined of the different market segments beyond the traditional, long-standing markets of Europe and North America, looking into the developments on a global scale. Main market segments, which make use of marine sensors include: Industrial water quality; Research, Offshore oil & gas; Environmental monitoring; Ocean renewable energy, Port security, Aquaculture & Fisheries and Deep sea mining.

1.2 Sensor interfacing and sensor web enablement

NeXOS recognized that helping users with data access and data visualization would stimulate adoption and provide practical benefits to the ocean observation and industry communities. At the sensor system level, the Smart Electronic Interface for Sensors and Instruments (SEISI)- supports both a pull-based data access interface (i.e. based on the SOS standard) as well as a push-mechanism for delivering data into observation databases. To provide these functions, non-SEISI systems needed to be integrated into the NeXOS Sensor Web architecture through dedicated Sensor Bridges. As part of this, NeXOS provided guidance on how to apply Sensor Web technology in oceanography (del Rio et al. 2014).

The main objective of the SEISI is to have an interface capable of providing a standard communication interface for non-standard sensors with analogue output and instruments with analogue or digital output (Fig. 1). SEISI is a set of standards and functionalities to enable web-based sharing, discovery, exchange and processing of sensor observations, and operation of sensor systems. NeXOS worked to minimize the integration time with different types of observing systems and platforms, and to maximize the interoperability with upper communication layers. Internet protocols were used for propagating data to the user's Sensor Web Level, by SWE standards. SensorML files with instrument metadata were installed in the instruments, to secure the correct dissemination of data and track-record the applications.

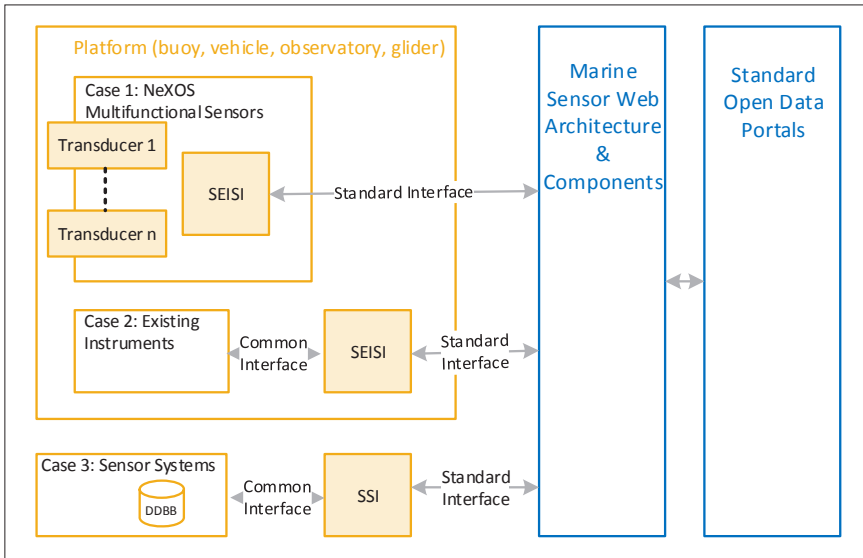

Fig. 1. Smart Electronic Interface for Sensors and Instruments (SEISI).

The SEISI reads the SensorML, a sensor metadata, from PUCK payloads in instruments, actuators, or platforms to automatically configure the onboard services (enable/disable SEISI input interface, or enable/disable output interface Ethernet, RS232). This was illustrated using a FerryBox scenario. In NeXOS, all sensors had a PUCK interface.

2. Validation and demonstration

Validation or verification was performed to document functionality, operability and data quality of a sensor on a specific platform. The sensor systems were then functionally demonstrated at sea under real oceanic conditions, over periods of several weeks. The final demonstrations took place during the summer of 2017 in areas of the Northeast Atlantic, the Central Atlantic and the Mediterranean. Each mission was given a Mission ID (Table II). The acoustic sensors were demonstrated on an underwater glider, on a wave glider, an underwater observatory and on a beacon. The optical sensors were demonstrated on a glider, a float, a buoy and in a FerryBox system. The EAF sensors were installed on fishing gear belonging to fishing vessels in Norway, France and Italy, respectively. An important part of the demonstrations was to document data flowing continuously from the sensors to the internet data viewer, and including the fixed sensor metadata provided in the embedded SensorML files. The functionality of the SOS server and the real-time data viewer was also demonstrated (Fig. 2). Here, multiple data time series and profiles can be selected. This service also includes a map tracing facility, and a data file download option.

Table II. The Platform/sensor pairing in NeXOS, according to the demonstration plan.

MATRIX OF PLATFORMS AND SENSORS					
SENSOR	PLATFORM NAME	PLATFORM OWNER	TYPE OF PLATFORM	SENSOR TO VALIDATE	TARGET DEMO MISSION
A1.4	ESTOCTB	PLOCAN	Stand Alone Mooring	A1	Can4
A1.1 / 01.4	Wave Glider	PLOCAN	Surface Glider	A1 / 01 matrixFlu UV	Can1 / Can2
A1.3	Provov	NKE	Profiler	A1	Can3
A1.2 / 01- Mini	Sea Explorer	ALSEAMAR	Glider	A1 / 01 MiniFluo	Nor2 / Nor1
03.2	Sail Buoy	CMR	Surface Vessel	03 Cbon2-sv	Nor3
03.1 / 03.4	Ferrybox	HZG/NIVA	Vessel	03 CBon2-fb / 03-Cbon3-fb	∫ Nor5
02.1 / 01.2 / 01.3	Ferrybox	HZG	Vessel	02 HyABS / 01 matrixFlu VIS/UV	∫ Nor4
EAF.3 / EAF.5	Fishing Vessel	REC	Vessel	EAF-3 DO / EAF-5 Fluo	Nor6
EAF.4 / EAF.6	Fos/Foos Vessel	CNR	Vessel	EAF-4 DO / EAF-6 Fluo	Med3
A2.1	Obsea	UPC	Cabled Observatory	A2	Med2
A1.e	Beacon	CNR	Moored buoy	A1	Med1
T3.2-	Biofouling test station	IFREMER	Basin/pool	Antifouling system	N/A

The NeXOS project successfully provided 8 new cost-effective sensor systems and products like an open-source SWE framework, a SML Editor, an Internet viewer and SOS services. This enables an open, end-to-end interoperability framework, with data flow from sensor to services and users. The firmware code for embedded processing (acoustics) is open-source, also like the code for plug and play between sensors and platforms. The outcomes should become beneficial to many users and earth observing Communities, from EMSO to GOOS/EuroGOOS and the GEOSS.

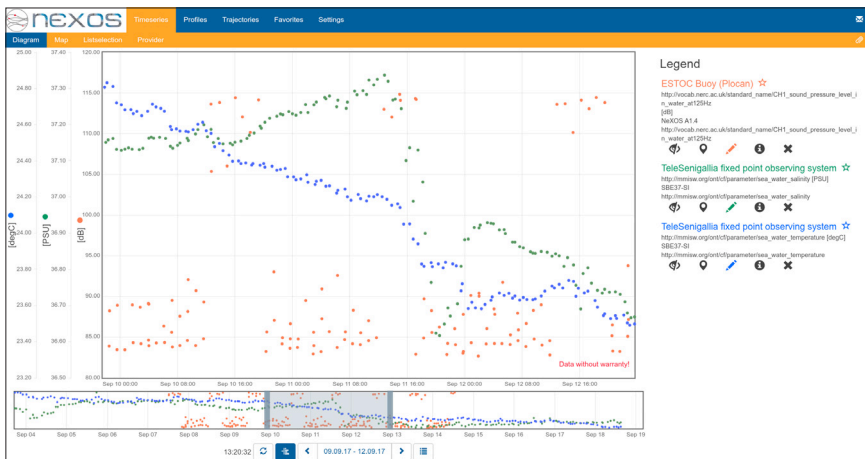

Fig. 2. Example of a data presentation from the SWE user front end viewer developed by 52oN. In this case, data from the ESTOC buoy by Plocan: sea temperature (blue dots), salinity (green dots) and sound level (orange dots).

Acknowledgements

The work reported here has been supported by the European Commission's FP7 research and innovation program under grant number 614102. We acknowledge the support from Statoil and Havila shipping for providing access to their offshore field and their vessels, respectively.

References

Delauney, L., K. Boukerma, K. Bucas, J-Y. Coail, M. Debeaumont, B. Forest, C. Garello, G. Guyader1, Y. Le Bras, M. Peleau and E. Rinnert. (2015). Biofouling protection by electro-chlorination on optical windows for oceanographic sensors and imaging devices OCEANS 2015 – Genova. ITALY, MAY 18-21, 2015, Pages 1-10.

Delory, E., D. Toma, J. Del Rio, P. Ruiz, L.Corradino, P. Brault and F. Fiquet. (2014). NeXOS objectives in multi-platform underwater passive acoustics. <http://www.uaconferences.org/index.php/component/contentbuilder/details/5/378/underwater-acoustics-conferences-unmanned-vehicles-auv,-usv-and-gliders-for-underwater-acoustic-surveillance-and-monitoring?Itemid=214>.

del Río, J., D. Mihai Toma, T.C. O'Reilly, A. Bröring, D.R. Dana, F. Bache, K.L. Headley, A. Manuel-Lazaro and D.R. Edgington. (2014). "Standards-Based Plug & Work for Instruments in Ocean Observing Systems," *Oceanic Engineering, IEEE Journal of*, vol.39, no.3, pp.430,443, July 2014. <http://dx.doi.org/10.1109/OCEANS-Genova.2015.7271715> <http://archimer.ifremer.fr/doc/00349/45998/>

Pearlman, J. and O. Zielinski. (2017). A new generation of optical systems for ocean monitoring. Matrix fluorescence for multifunctional ocean sensing. *Sea Technology*, February 2017, 30-33

Sadin, S., F. Pavinelli and R. Rosen (1989). NASA technology push towards future space mission systems. In: Space and Humanity Conference Bangalore, India, Selected Proceedings of the 39th International Astronautical Federation Congress, *Acta Astronautica*, vol. 20, pp 73-77, 1989.

ACOUSTIC TOMOGRAPHY AS A COMPONENT THE ATLANTIC OCEAN OBSERVING SYSTEM: OPPORTUNITIES AND CHALLENGES

B. Dushaw

Nansen Environmental and Remote Sensing Center, Thormøhlens gate 47, N-5006 Bergen, Norway
brian.dushaw@nersc.no

Abstract

Ocean acoustic tomography is a unique measurement of large-scale ocean variability. The travel times of acoustic signals measure large-scale temperature, barotropic current, and, with an array of transceivers, relative vorticity. Applications include measurements of currents in shallow harbors, basin- and global-scale temperature, and deep-water formation events at high latitudes. Acoustical observations in ice-covered regions are compelling. All such systems provide for underwater GPS. The common perception that the Argo float system obviates the need for acoustic tomography is an error. While tomographic systems as components of regional or global-scale Ocean Observing Systems represent real opportunities for new insights into long-term ocean variability, the practical implementations of sustained acoustical systems are challenging. Such challenges are programmatic or cultural, rather than scientific, however. Given the extraordinary climatological changes presently occurring, it is imperative that all available observational capabilities be thoroughly considered. Studies employing numerical ocean models are required to design optimal observing strategies that exploit the complementary nature of different measurements. Observing Systems require practical techniques to implement data assimilation with the tomographic measurements. Programmatic technical capability and manpower to sustain acoustical measurements is lacking. Successful implementation of tomographic systems will require a stronger symbiotic relation between acousticians and oceanographers.

Keywords: ocean acoustic tomography, integrated temperature measurement, physical oceanography, underwater GPS, long-range acoustic propagation, basin-scale acoustics

1. Introduction

The possible acoustical applications for an ocean observing system are myriad and cross several disciplines, but a review or survey of these applications is beyond the scope of this paper (See Dushaw, *et al.* 2001; Dushaw, *et al.* 2010; Mikhalevsky, *et al.* 2015). The discussion here addresses ocean acoustic tomography (Munk 1986; Munk *et al.* 1995; Dushaw 2013) and ocean observing systems. This document does not present a technical case for why tomography should be a part of the observing system; that case has been made elsewhere (Dushaw, *et al.* 2001; Dushaw, *et al.* 2010; Mikhalevsky, *et al.* 2015). Rather, this document aims to continue the process of building communities for designing, implementing, and sustaining tomography measurements within Ocean Observing Systems (e.g., Dushaw 2016).

2. Atlantic Basin acoustical systems

Almost 20 years ago, the OceanObs99 conference concluded (“Conference Statement” 1999):

“That acoustic tomography did represent a potentially valuable approach and that, initially, it should be implemented in the Arctic and at specific locations such as the Straits of Gibraltar. The Conference also encouraged an exploratory implementation in the North Atlantic in the presence of substantial profiling floats to test the complementarity and/or redundancy between tomography and other measurements.”

As the Conference Statement explicitly noted, “For tomography, there is support for a pilot project in the N. Atlantic.” (“Conference Statement” 1999). Unfortunately, there was little organized effort by acousticians to follow up and build on this consensus (the focus of many of those working on tomography at the time was the North Pacific). The issue remains unresolved, and an acoustic tomography program in the North Atlantic still has every indication of providing substantial new information about the evolving state of the ocean.

The effectiveness of an acoustic tomography observing network for the North Atlantic can be assessed using simulated acoustic transmissions in a high-resolution numerical ocean model. The North Atlantic is a region of rapid climate variability, with temperature changes expected to extend into the abyssal ocean at time scales much shorter than in other ocean basins. Long-range acoustic transmissions may effectively sense average temperature, including abyssal volumes. The optimal design and cost effectiveness of a basin-wide acoustical observing network can be assessed using the simulations. In particular, the simulated acoustic data can be considered in combination with data assimilation techniques and existing data types to quantify the enhanced resolution of large-scale or deep oceanic variability afforded by the acoustic data.

As the 1999 OceanObs conference statement highlighted, one long-lingering question has been the degree of difference between Argo float and tomography measurements. Despite the lack of evidence supporting it, one common perception is that the existence of the Argo float system obviates the need for acoustic tomography. There is considerable evidence that perception is an error. In 1996, Morawitz, *et al.* (1996) examined the combination of hydrographic, acoustic, and moored data in resolving events of deep water formation in the Greenland Sea (Fig. 1). Even during a time of dense hydrographic sampling, the tomography data was essential to resolving the variability. Dushaw, *et al.* (2009) compared basin-scale acoustic data obtained in the North Pacific with equivalent data computed from objective maps of the ocean based on Argo float data and satellite altimetry. The comparison showed little agreement, indicating little redundancy between Argo and acoustic data. Similarly, a direct comparison of the information content of a line array of moored thermistors with tomography using objective mapping techniques explicitly illustrated the complementarity of those two data types (Dushaw and Sagen 2016). The information from sparse hydrographic profiles is not redundant with the information from the line- and depth-averages of tomography.

Over the past few decades, the Atlantic has hosted a number of tomography or long-range propagation experiments. Fig. 1 shows the locations of several tomography experiments from 20-50 years ago; no such experiments have been conducted in recent years. The AMODE, SYNOP, CAMBIOS, MOVE, and Labrador Sea experiments were regional, process-oriented studies, from mesoscale dynamics to meridional overturning circulation to deep-water formation (Dushaw *et al.* 2001; Dushaw *et al.* 2010). The Perth-Bermuda experiment was a test of antipodal acoustic propagation in 1960 that was analyzed as a measure of global-scale temperature change over a half century (Dushaw and Menemenlis 2014). The acoustic propagation spanned the South and North Atlantic Oceans, with the acoustic signals confined near the sound channel axis.

At present there are no specific plans for deployment of acoustic tomography in the Atlantic. Several notional schemes have been identified in the past, and remain viable options (SCOR WG 96, 1994; an update is in order!). Studies are required to demonstrate the utility of such observations and derive optimal configurations for deployment (e.g., Dushaw and Rehm 2016, Johannessen *et al.* 2001). Fig. 1 illustrates three possibilities: (1) an array of six transceivers to observe the western subtropical Atlantic basin, (2) trans-Atlantic Ocean measurements modeled after the basin-scale ATOC measurements of the North Pacific, and (3) two acoustic paths to augment the RAPID measurements of meridional overturning along 26.5°N. Since 2004, the RAPID program (www.rapid.ac.uk) has maintained an array of about 20 moorings along 26.5°N across the Atlantic to observe the strength and structure of the meridional overturning circulation (MOC). The western Atlantic array could certainly be used to map and monitor the climatic variations of the region, and perhaps to monitor the net volume of mode (18°C) water (an idea due to Wunsch). Acoustic propagation along the notional basin-scale path was originally tested by Ewing in 1945. The measurement highlights

Bermuda as a convenient location for a sustained receiving array. Deployments such as these are modest by today's standards, and the maintenance of the RAPID array of moorings over the past decade illustrates the successful strategy of yearly deployments of moorings in maintaining a system. Acoustical systems cabled to shore remain the ideal solution, however.

3. Discussion

Despite the compelling case for the information provided by acoustic tomography and community support for such measurements, tomographic systems have yet to be implemented as part of an Observing System. This deficiency has been disappointing. Its ultimate causes appear to have been a failure of the acoustic and oceanographic communities to meld and a challenging funding environment. At the programmatic level, avenues of funding for sustained acoustical measurements have been precluded. Ultimately, successful implementation of tomographic systems will require a stronger symbiotic relation between acousticians and oceanographers (Dushaw, *et al.* 2016).

While deployments of tomographic systems as components of the Ocean Observing Systems (regional or global scales) represent real opportunities for new insights into long-term ocean variability, the practical implementations of sustained acoustical systems are a challenge. At present, such challenges are programmatic or cultural, rather than scientific, however. Given the extraordinary climatological changes presently occurring in the Earth's ocean-atmosphere system, it is imperative that all available observational capabilities undergo a thorough consideration.

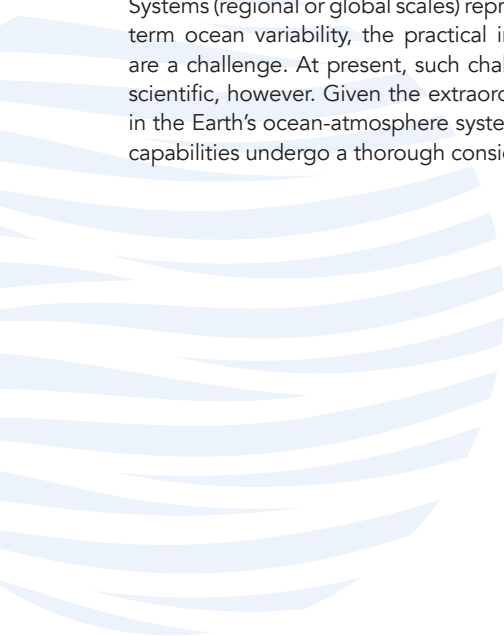

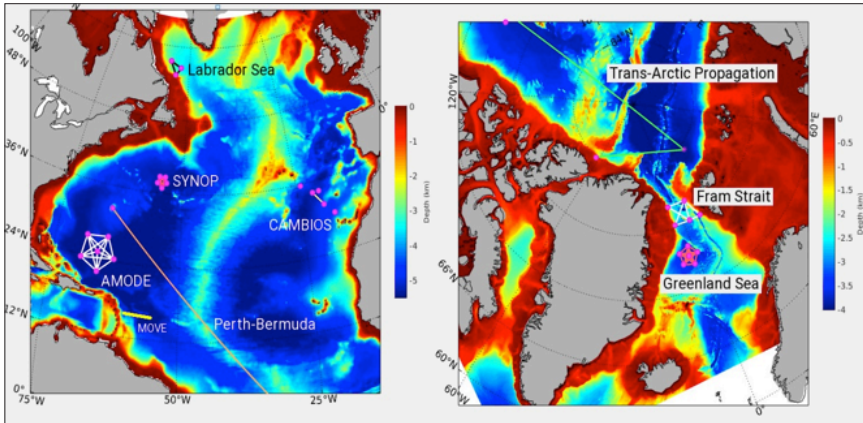

Fig. 1. Past observations in the Atlantic include the Acoustic Mid-Ocean Dynamics Experiment (AMODE), the SYNoptic Ocean Prediction (SYNOP) experiment, the Labrador Sea experiment, the Canary-Azores-Madeira Basin Integral Observing System (CAMBIOS), and the MOVE array along 16°N for monitoring the Meridional Overturning Circulation. The Perth-Bermuda experiment was antipodal, with acoustic propagation across the South and North Atlantic. Experiments in the Arctic Regions include the Greenland Sea Project, the Trans-Arctic Acoustic Propagation (TAP) experiment, and the series of deployments in Fram Strait (DAMOCLES, ACOBAR, UNDERICE). Azimuthal equal area projection.

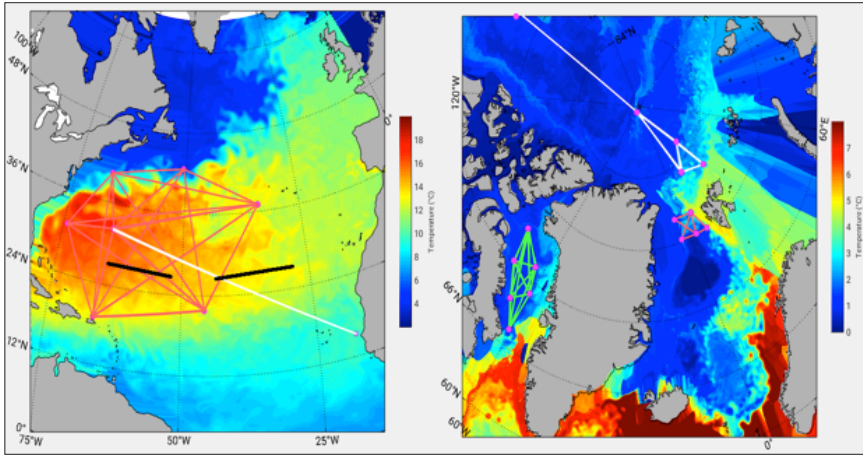

Fig. 2. Notional future observations in the Atlantic include an array in the western North Atlantic (pink), a basin-scale path from Senegal to Bermuda (white), and two paths along 26.5°N augmenting the RAPID array monitoring of the MOC (black). Possible sustained observations in the Arctic Regions include an array in Fram Strait (pink), a regional and trans-Arctic array north of Svalbard (white), and a regional observatory in Baffin Bay (green). Both panels show temperature (@500m Atlantic, @300m Arctic) derived from ECCO2 project state estimates.

Acknowledgements

B.D.D. was supported by ONR Grant N00014-15-1-2186. Any opinions, findings, and conclusions or recommendations expressed in this publication are those of the authors and do not necessarily reflect the views of the Office of Naval Research.

References

“Conference Statement” of the First International Conference on the Ocean Observing System for Climate (OceanObs99), St. Raphael, France, 18-22 October 1999. <http://unesdoc.unesco.org/images/0012/001205/120594eo.pdf>

“Conference Statement” in *Proceedings of OceanObs’09: Sustained Ocean Observations and Information for Society* (Vol. 1), Venice, Italy, 21-25 September 2009, Hall, J., Harrison, D.E. & Stammer, D., Eds., ESA Publication WPP-306, doi: 10.5270/OceanObs09.Statement.

Dushaw, B. (2016). Ocean acoustic tomography: A missing element of the ocean observing system, in *Proceedings Acoustic & Environmental Variability, Fluctuations and Coherence*, Institute of Acoustics, Cambridge, U.K. 12–13 December 2016, 5 pp., http://staff.washington.edu/dushaw/epubs/Dushaw_Tomography_Opinion_Cambridge_2016.pdf.

Dushaw, B. D. (2013). "Ocean Acoustic Tomography" in *Encyclopedia of Remote Sensing*, E. G. Njoku, Ed., Springer, Springer-Verlag Berlin Heidelberg, 2013, ISBN: 978-0-387-36698-2.

Dushaw, B. and E. Rehm (2016). Acoustic Tomography in Baffin Bay: A Preliminary Survey, NERSC Technical Report No. 375, 20 October 2016, 33 pp., doi: 10.13140/RG.2.2.15772.28806, https://www.researchgate.net/publication/313844561_Acoustic_Tomography_in_Baffin_Bay_A_Preliminary_Survey.

Dushaw, B. D. and H. Sagen (2016). A comparative study of moored/point and acoustic tomography/ integral observations of sound speed in Fram Strait using objective mapping techniques, *Journal of Atmospheric and Oceanic Technology*, 33, 2079–2093, doi: 10.1175/JTECH D 15 0251.1.

Dushaw, B. D. and D. Menemenlis (2014). Antipodal acoustic thermometry: 1960, 2004, *Deep-Sea Research I*, 86, 1–20, doi: 10.1016/j.dsr.2013.12.008.

Dushaw, B. D., G. Bold, C.-S. Chui, J. Colosi, B. Cornuelle, Y. Desaubies, M. Dzieciuch, A. Forbes, F. Gaillard, J. Gould, B. Howe, M. Lawrence, J. Lynch, D. Menemenlis, J. Mercer, P. Mikhaelovsky, W. Munk, I. Nakano, F. Schott, U. Send, R. Spindel, T. Terre, P. Worcester, and C. Wunsch (2001). "Observing the ocean in the 2000's: A strategy for the role of acoustic tomography in ocean climate observation" in *Observing the Oceans in the 21st Century*, edited by C. J. Koblinsky and N. R. Smith (GODAE Project Office and Bureau of Meteorology, Melbourne), pp. 391–418.

Dushaw, B. D., P. F. Worcester, W. H. Munk, R. C. Spindel, J. A. Mercer, B. M. Howe, K. Metzger Jr., T. G. Birdsall, R. K. Andrew, M. A. Dzieciuch, B. D. Cornuelle, and D. Menemenlis (2009). A decade of acoustic thermometry in the North Pacific Ocean, *Journal of Geophysical Research*, 114, C07021, doi: 10.1029/2008JC005124.

Dushaw, B., W. Au, A. Beszczynska-Möller, R. Brainard, B. D. Cornuelle, T. Duda, M. Dzieciuch, A. Forbes, L. Freitag, J.-C. Gascard, A. Gavrilov, J. Gould, B. Howe, S. R. Jayne, O. M. Johannessen, J. F. Lynch, D. Martin, D. Menemenlis, P. Mikhalevsky, J. H. Miller, S. E. Moore, W. H. Munk, J. Nystuen, R. I. Odom, J. Orcutt, T. Rossby, H. Sagen, S. Sandven, J. Simmen, E. Skarsoulis, B. Southall, K. Stafford, R. Stephen, K. J. Vigness-Raposa, S. Vinogradov, K. B. Wong, P. F. Worcester, and C. Wunsch (2010). A Global Ocean Acoustic Observing Network, In *Proceedings of OceanObs'09: Sustained Ocean Observations and Information for Society* (Vol. 2), Venice, Italy, 21–25 September 2009, Hall, J., Harrison, D.E. & Stammer, D., Eds., ESA Publication WPP-306.

Johannessen, O. M., S. Sandven, H. Sagen, T. Hamre, V. J. Haugen, P. Wadhams, A. Kadetzky, N. R. Davis, K. Hasselmann, E. Maier-Reimer, U. Mikolajewicz, V. Doldatov, L. Bobylev, I. B. Esipov, E. Evert, and K. A. Naugolnykh (2001). Acoustic monitoring of the ocean climate in the Arctic Ocean, AMOC Final Report, NERSC Technical Report No. 198, January 2001.

Mikhalevsky, P. N., H. Sagen, P. F. Worcester, A. B. Baggeroer, J. Orcutt, S. E. Moore, C. M. Lee, K. J. Vigness-Raposa, L. Freitag, M. Arrott, K. Atakan, A. Beszczynska-Möller, T. F. Duda, B. D. Dushaw, J. C. Gascard, A. N. Gavrilov, H. Keers, A. K. Morozov, W. H. Munk, M. Rixen, S. Sandven, E. Skarsoulis, K. M. Stafford, F. Vernon, and M. Y.

Yuen (2015). Multipurpose acoustic networks in the integrated Arctic Ocean observing system, *Arctic*, 68, Suppl. 1, 17 pp., doi: 10.14430/arctic4449.

Morawitz, W. M. L., B. D. Cornuelle, and P. F. Worcester (1996). A case study in three-dimensional inverse methods: Combining hydrographic, acoustic, and moored thermistor data in the Greenland Sea. *Journal of Atmospheric and Oceanic Technology*, 13, 659–679.

Munk, W. (1986). Acoustic monitoring of ocean gyres, *Journal of Fluid Mechanics*, 173, 43–53, doi: 10.1017/S0022112086001064.

Munk, W., P. Worcester, and C. Wunsch (1995). *Ocean Acoustic Tomography*, Cambridge, UK: Cambridge University Press, 456 pp.

SCOR WG 96 (Scientific Committee on Ocean Research Working Group 96) (1994). Atlantic sub-group: W. J. Gould, Y. Desaubies, B. M. Howe, D. R. Palmer, F. Schott, and C. Wunsch, *Acoustic Thermometry in the Atlantic: A Report to SCOR WG 96*, http://staff.washington.edu/dushaw/epubs/SCOR_WG96.pdf.



NEW ACOUSTIC PROFILING INSTRUMENTATION WITH OPTODE MEASUREMENTS OF pCO₂ AND PH TESTED IN THE SOUTHERN ADRIATIC

V. Cardin⁽¹⁾, A. Tengberg⁽²⁾, M. Bensi⁽¹⁾, E. Dorgeville⁽²⁾, M. Giani⁽¹⁾, G. Siena⁽¹⁾, F. Brunetti⁽¹⁾, L. Ursella⁽¹⁾, S. Kuchler⁽¹⁾, A. Bubbi⁽¹⁾, P. Mansutti⁽¹⁾ and F. Arena⁽¹⁾

⁽¹⁾ Istituto Nazionale di Oceanografia e di Geofisica Sperimentale, OGS, Trieste, Italy. vcardin@inogs.it

⁽²⁾ Aanderaa/Xylem, Bergen, Norway

Abstract

In the framework of the FP7-European project FixO3 (Fixed point Open Ocean Observatory network) a new type of Acoustic Doppler Current Profiler (SeaguardII-DCP) was installed and tested at the E2-M3A site (<http://www.fixo3.eu/observatory/E2-M3A/>) in the southern Adriatic Sea (Eastern Mediterranean). The aim of the experiment was to evaluate the performance of this technology in clear/oligotrophic waters, which are known to affect negatively the acoustic range and performance. The instrument was also equipped with auxiliary sensors for pCO₂, pH, O₂ and Temp. The minimal range of the Doppler Current Sensor was 45-50m and did not vary significantly between summer and winter seasons. Parallel experiments have shown that using broadband technology from "rocking" platforms like a buoy gives bad data quality, therefore in buoy applications narrow band is preferred. In addition, the collaboration between OGS and Aanderaa provided the opportunity to improve the data quality of an RCM-Seaguard installed at 1160m depth, 20m above the bottom. Significant improvements were achieved in the data quality of the deep-water instrument by better quality control methods between deployments and by decoupling the sacrificial Zn anode from the instrument.

Keywords: Adriatic, Technology Development, DCPS=Doppler Current Profiling Sensor, Improved QC

1. Introduction

The Adriatic is an important player for the circulation in the Mediterranean Sea, which on a smaller scale behaves as an ocean, and represents one of the most important sites of deep water formation [1]. The E2-M3A Observatory, a two mooring system, is located in the area of the Southern Adriatic Pit at 41°50.0'N, 17°45.0'E [2]. It provides precious information and long sustained high frequency measurements of multiple interrelated variables from the sea surface to the seafloor to resolve events and rapid processes. The automatic monitoring of the carbonate system set up on the E2-M3A buoy measures two of its main variables i.e. the partial pressure of CO₂ (pCO₂) and the pH. This allows a better understanding of the processes influencing the carbonate system in the southern Adriatic, especially during winter cooling, when dense waters are formed. The aim of the carbonate system automatic monitoring is to understand the role of this physical pump for the transfer process of the CO₂ when winter cooled waters sink forming the Adriatic Dense Water (ADW) which, flowing through Otranto strait, contribute to the Eastern Mediterranean Deep Water.

2. Materials and methods

2.1 Downward looking SeaGuard II below surface buoy

In the framework of the FP7-European project FIXO3 (Fixed point Open Ocean Observatory network) and within the Trans National Access to the Observatories of the network (TNA) a SeaGuardII-DCPS was deployed under the surface buoy of the E2-M3A observatory (Fig. 1) for testing of the acoustics in clear oligotrophic waters in the spring of 2015. It was serviced and redeployed in the autumn of 2015, and finally recovered in the spring of 2017. The Doppler Current Profiling Sensor has features including: User selectable Broadband and Narrowband, Automatic 3 beam/4 beam selection for optimal data quality and object avoidance, Simultaneous upward and Downward profiling by connecting two acoustic sensors, Spread or Burst mode without enhanced power consumption and the ability to sample sensors connected to the instrument at different time intervals. In addition to the current sensor the instrument was equipped with three optodes to measure O₂ (standard 4835), pCO₂ (model 4797) and pH (prototype). They also measure temperature and were set to sample every 30 minutes while the DCPS was measuring currents every 40 s.

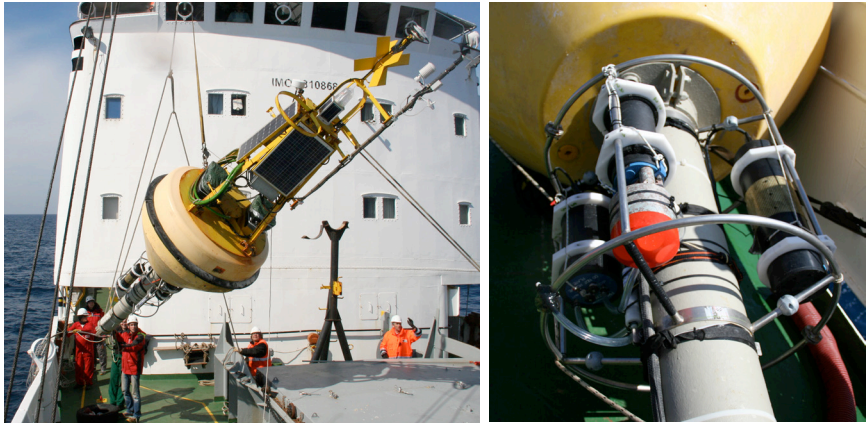

Fig. 1. The sensors placed on the SeguardII-DCP (orange head) attached to a special cage a few meters under the sea surface on the buoy.

2.2 Single point SeaGuard at 1250 m, improvement of data quality

A single point SeaGuard instrument (from Aanderaa) has been used on the E2-M3A deep mooring at 1250m depth since 2013. It is equipped with sensors to measure: currents (single point), oxygen, salinity, depth/tide, turbidity (Particles) and temperature (from 4 sensors). The instrument has collected data reliably since the start but there have been doubts about the quality of the salinity measurements, compared with a nearby SeaBird sensor. Therefore in the frame of this TNA we also focus on improved data quality collected by the SeaGuard including: eliminating potential effects of the Zn anode that is placed on the top plate of the instrument by moving it, better quality control between deployments and investigating the possibility of using acoustic backscatter from the Z-pulse (double pulse) current sensor as a proxy for particles in the water.

3. Results

3.1 Downward looking SeaGuard II below surface buoy

The minimal range of the Doppler Current Profiling Sensors (DCPS) was between 45-50m. It did not vary significantly between summer and winter seasons (Fig. 2). This was surprising considering that normally during the winter season there is fewer scattering particles in the water. Possibly one explanation could be that the summer stratification, at about 35m depth creates some reflections that partly prevents the signal to reach deeper. In less oligotrophic waters the range of the DCPS can be up to 100m.

The DCPS can be set to run either broadband or narrowband. Parallel tests of these settings have shown that due to signal ambiguity reasons it is not suitable to use broadband from moving platforms like a buoy [3]. The noise level becomes very high which lowers the data quality significantly.

3.2 Optode (O_2 , pH and pCO_2) measurements in surface waters

Fig. 3 shows parallel O_2 and pH measurements of optodes compared with colorimetric (Sami pH) and infrared (PSI pCO_2) instruments on the buoy. Due to a power regulation failure on the SeaGuardII instrument the mounted optodes were electronically damaged and only a short period (four months) of parallel data with other instruments was obtained.

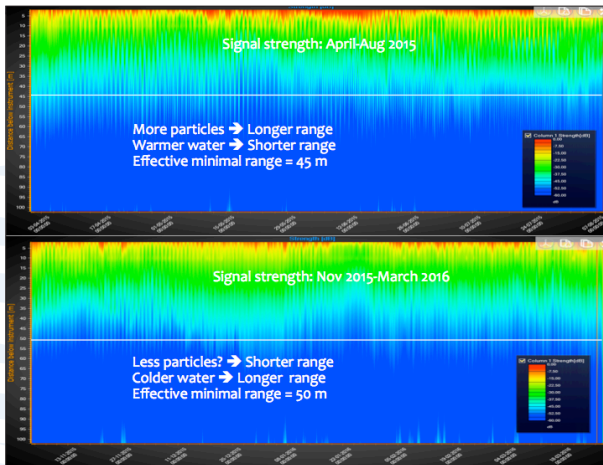

Fig. 2. Effective range of the DCPS during summer (above) and winter (below) illustrated by signal strength plots. Since these trial the acoustic hardware of the sensor has been improved increasing the range with about 10%.

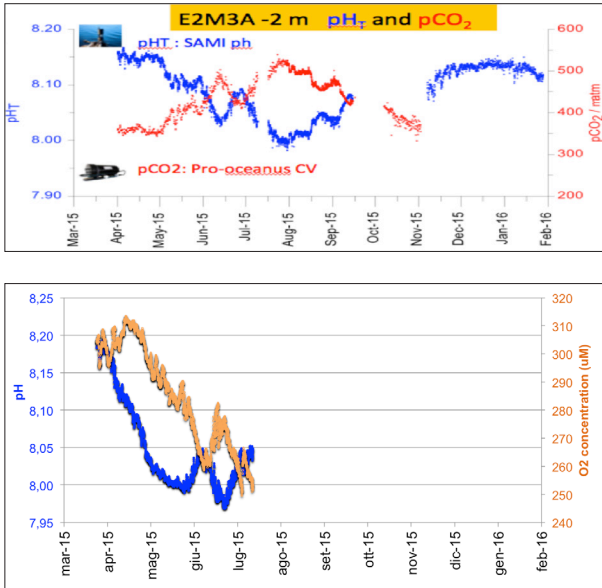

Fig. 3. Parallel Colorimetric pH (SAMI) and IR instrument pCO₂ (Pro-Oceanus), (upper panel) part of the payload of the E2M3A observatory, and pH and O₂ optode data from the SeaGuard II instrument, lower (panel). The O₂ optode recordings track well with Sami pH and are anti-correlated to the pCO₂.

3.3 Single point SeaGuard at 1250 m, improvement of data quality

Several steps were taken to improve the data quality of the measurements from the deep water SeaGuard deployed at E2-M3A since 2013. The sacrificial Zink anode that protects the stainless steel screws on the instrument, the rest is made of Titanium, was removed from the top plate and placed higher up on the instrument handle. This resulted in that the initial drift seen on cond/sal data disappeared. The reason for this is a proximity effect because the change in the metal surface of the Zn anode will influence the cond/sal response when these are placed close, within 10cm from each other. In addition the oxygen optode was decoupled from the Zink anode by cable connecting it to the instrument. This removed noise in the readings because oxygen is consumed at all naked metal parts in contact with the Zink anode, which creates packages of low O₂ water that can be visible as noise at low currents (Fig. 4).

There are several simple best practice measures that can be taken in-between deployments to improve the data quality mainly by checking if the sensors have drifted and are working correctly. It is recommended to let the instrument log in "free air" (not inside the laboratory) several hours before and after the deployment. By knowing the local air-pressure both oxygen [4] and pressure sensors can be checked. It was found in this project that the oxygen optode was showing 9% too low but that it did not drift over the 4-year deployment period that is reported on here. Also pressure data from the deep water rated pressure sensor indicated that there was no drift since it was tracking with air-pressure in-between deployments (Fig. 4).

Aanderaa has made it simple also to do field control of the single point Doppler Current Sensor (using a DCS test unit) and the cond/sal sensor using a resistor loop. In addition most Aanderaa smart sensors include high quality temperature measurements, which normally agree unless there is an electronic/calibration error with a sensor.

Not only does the Doppler Current Sensor provide current and mooring movement, through compass and accelerometer, the signal strength data from the acoustic sensor gives an independent well defined measurement of suspended matter (Fig. 5) that was working better in this case than the dedicated turbidity sensor which is easily disturbed by single objects.

Close to the SeaGuard was a Seabird instrument measuring salinity, temperature, pressure and oxygen. Comparing data from the two instruments reveal that the Seabird salinity measurements was of better quality while for pressure and oxygen it was the contrary and the SeaGuard sensors were more stable. For temperature the data quality was similar. It is not recommended to log the Seabird sensor in air therefore the possibility of air measurements in between deployments is difficult to do. The SeaGuard has given 100 % data return since it was deployed in 2013 while the Seabird instrument had gaps.

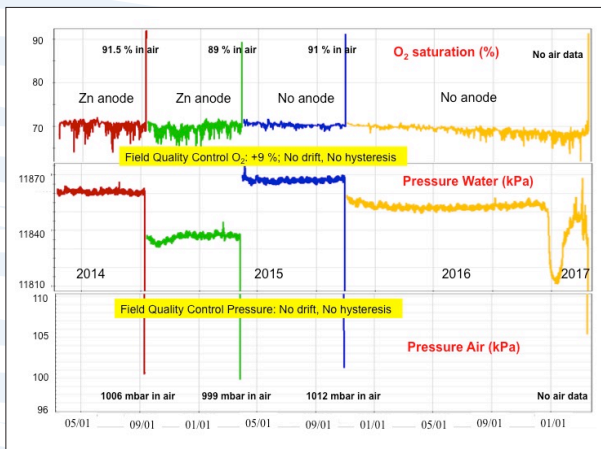

Fig. 4. Simple field quality control letting the instrument log in air. The example shows quality control of the pressure sensor and the oxygen optode mounted on the SeaGuard.

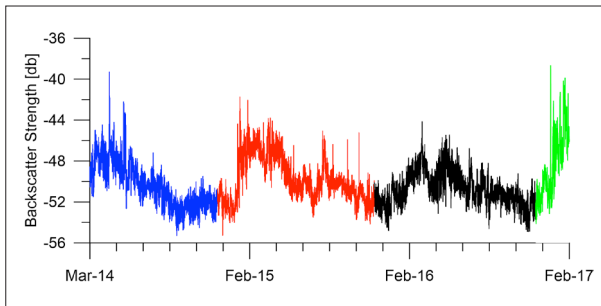

Fig. 5. Acoustic backscatter variations over a +3 year period from the Doppler Current Sensor give evidence of stable particle readings and seasonality. These data should be compared with sediment trap information.

4. Conclusions

The opening of fixed open ocean observatories under the FP7-European FIXO3 project (the Open Ocean Observatory network) and within Trans National Access was designed to offer the broadest scientific and technological capabilities to wide range of users. Besides being an opportunity for scientists, e.g. to collect new observations or test new methodologies, the transnational access offers also *in situ* bench marks to industry and academy for testing prototypes and/or adapting existing instrumentation to new targeted uses. In this context the opening of the E2M3A Observatory allowed evaluating new technologies such as SeaGuardII-DCPS evaluating the performance of this technology in clear/oligotrophic waters. Data obtained from this instrument indicated that the signal propagates satisfactorily for a layer range of more or less 40 to 50m, although expected more for a 600 kHz. This instrument, together with new auxiliary sensor for $p\text{CO}_2$ and pH, gave us valuable information about seasonal dynamics of the upper layer.

The collaboration between OGS and Aanderaa provided also the interesting opportunity to improve the data quality of the RCM-Seaguard installed at 1160m depth (20m above the bottom) at the E2M3A deep mooring since 2013. Technical experiments were performed *in situ* to verify and reduce the disturbance induced by zinc anodes and metal ballasts on the instrument.

Acknowledgements

This work has received funding from the European Union Seventh Framework Programme (FP7/2007-2013) under grant agreement n°. 312463, FixO3 (Fixed point Open Ocean Observatory network, <http://www.fixo3.eu/>). E2M3A experimental data are available at <http://nettuno.ogs.trieste.it/e2-m3a/>. We also thank the captain and the crew of the RV OGS Explora for their support during the maintenance cruises.

References

- [2] Bensi M., Cardin V., Rubino A. (2014). Thermohaline Variability and Mesoscale Dynamics Observed at the Deep-Ocean Observatory E2M3A in the Southern Adriatic Sea. In: The Mediterranean Sea: Temporal Variability and Spatial Patterns, Chapter 9. *Geophysical Monograph* 202. First Edition. Edited by Gian Luca Eusebi Borzelli, Miroslav Gačić, Piero Lionello, and Paola Malanotte-Rizzoli. 2014 American Geophysical Union. Published 2014 by John Wiley & Sons, Inc.
- [1] Cardin V., Bensi M. and Pacciaroni M. Variability of water mass properties in the last two decades in the Southern Adriatic Sea with emphasis on the period 2006-2009. *Continental Shelf Research*, 2011. doi:10.1016/j.csr.2011.03.002.
- [4] Johnson K.S. & J. Plant (2015) Air Oxygen Calibration of Oxygen Optodes on a Profiling Float Array. *Journal of Atmospheric and Oceanic Technology*, 32, 2160-217.
- [3] Tengberg A., J. Hovdenes & H. Tholo (2017) Oceanographic Wave Measurements on Hydrography & Navigation Buoys: Introduction, Technology and MOTUS. Aanderaa/Xylem White Paper.



CURRENT AND EMERGING IN SITU BIOGEOCHEMICAL OBSERVATIONS USING THE FERRYBOX PLATFORM IN SUBARCTIC AND ARCTIC NORWEGIAN WATERS

A.L. King⁽¹⁾, M. Norli⁽²⁾, A.B. Ledang⁽²⁾, P. Jaccard⁽²⁾, E. Reggiani⁽²⁾,
S. Marty⁽²⁾, R.G.J. Bellerby⁽¹⁾, L. Golmen⁽¹⁾ and K. Sørensen

⁽¹⁾ Norwegian Institute for Water Research, Thormøhlensgate 53D, Bergen NO-5006; andrew.king@niva.no

⁽²⁾ Norwegian Institute for Water Research, Gaudstadalleen 21, Oslo, NO-3049

Abstract

In situ observations of the Norwegian coasts and oceans have been made with a network of ships of opportunity (FerryBox) since 2001. The FerryBox system is an autonomous, sensor-equipped, underway flow-through system deployed on passenger and container ships that operate in socioeconomically and environmentally relevant ocean regions including the North Sea/Skagerrak, the Barents Sea opening, and the western Norwegian coast. The basic sensor package measures seawater temperature, salinity, oxygen, chlorophyll-a fluorescence, and turbidity; and above water sensors measure wind, air pressure, and radiance/irradiance. In recent years, as part of EU sensor and ocean observation projects (JERICO-NEXT, NeXOS, MARIABOX, INTAROS), we have been developing emerging sensor and sampling technologies for use with FerryBox systems to measure inherent optical properties (including cDOM), phytoplankton functional groups, contaminants/toxins, microplastics, and carbonate system variables (pH, pCO₂, [CO₃]). These sensors provide knowledge pertaining to satellite ocean colour validation and Marine Strategy Framework Directives-related issues including the timing and duration of harmful algal blooms and eutrophication events, the prevalence and dispersion of contaminants and marine litter, and temporal and spatial variability in ocean acidification. These observations are also used to inform national monitoring programs, as well as a demonstration platform in the EU Ocean Literacy project ResponSEable.

Keywords: FerryBox, phytoplankton blooms, ocean acidification, contaminants, microplastics

1. Introduction

Modern FerryBoxes, autonomous sensor packages that make oceanic measurements on ships of opportunity like ferries and container ships, have been in operation since the early 1990's (Ainsworth, 2008). The NIVA FerryBox network consists of four ships that operate in the North Sea (M/S Color Fantasy: Oslo, Norway – Kiel, Germany), the North Atlantic Ocean (M/S Nörrona: Denmark – Iceland), the coastal Norwegian Sea and Arctic Ocean (M/S Trollfjord: Bergen, Norway – Kirkenes, Norway), and the Barents Sea opening (M/S Norbjørn: Tromsø, Norway – Longyearbyen, Svalbard) (Fig. 1). The network covers several important ocean regions. The North Sea is heavily trafficked by marine vessels and constitutes a significant flux of material into the North Atlantic. The North Atlantic Ocean transect from Denmark to Iceland bisects the primary branch of the North Atlantic Current that delivers heat and biogeochemical contents to the Arctic. The coastal Norwegian Sea and Arctic Ocean is home to the largest (salmon) aquaculture operation in Europe, fossil fuel extraction activities, and large freshwater input and mixing from the massive terrestrial watersheds. And finally, the Barents Sea opening is not only a region of importance for wild fishery harvesting and fossil fuel exploration, but it is in the Arctic, a region currently experiencing the largest rate of change of any large marine ecosystem due to climate change.

Ships of opportunity FerryBox-based observations offer the potential for studies on unique spatial and temporal resolution scales. As described above, the spatial coverage formed by a network of FerryBoxes can be quite expansive and also sample a number of different marine ecosystems. In terms of temporal coverage, some routes run by ferryboats transect the same water mass once daily throughout the entire year, while some vessels have operated the same transect for decades, potentially providing observations for addressing questions that are diel in nature, as well as on longer intra- and inter-annual timescales.

The FerryBoxes currently in operation share a core suite of a debubbler, pump(s), sensors, and communications hardware and software. The basic system pumps seawater from the ship's hull directly into a sensor package that measures salinity and temperature. Most systems also have sensors for measuring turbidity, chlorophyll a fluorescence, and oxygen, as well as a refrigerated autosampling system that can take discrete samples (into empty containers or containers preloaded with preservative solutions) either pre-programmed or triggered remotely by satellite internet connection.

A deckboard sensor package is also present on several of the ships that include measurements of wind speed/direction and upwelling/downwelling radiation. These variables provide basic oceanographic and biogeochemical data for understanding, for example, seasonal variability in cooling/warming, influence of freshwater input, and phytoplankton bloom timing and extent (and eutrophication and harmful algal bloom events). Auxiliary data on nutrient concentrations and phytoplankton species composition can be gathered using the autosampler for taking discrete samples for analysis back in the lab.

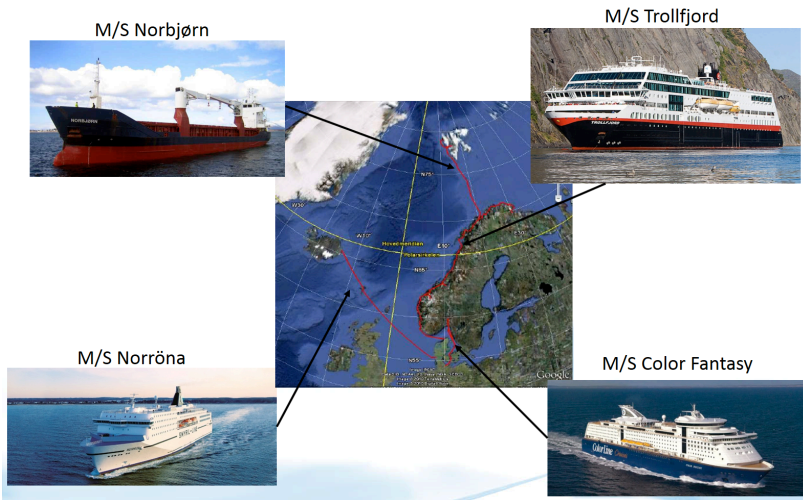

Fig. 1. A map showing transects of FerryBox ships in operation by NIVA. The ships operate in a variety of locations including the North Atlantic to the Arctic Ocean, in the North Sea, and along the coast of Norway.

2. Emerging sensors and sampling technologies

In recent years, several type of sensors and sampling technologies have been developed alongside the FerryBox systems to address pressing issues in the ocean. One of the most important developments has been with regards future ocean acidification projections and the need for making high quality measurements of carbonate system variables like pH, pCO₂, total alkalinity, and total dissolved inorganic carbon – to both better characterize present day variability and to be able to measure long term change. As part of several FP7 and Horizon 2020 projects (NEXoS, JERICO-NEXT, INTAROS) and NIVA institutional funding support, we are currently using and continuing to develop a spectrophotometric pH sensor that measures pH using the indicator dye thymol blue (Reggiani *et al.*, 2016), a non-dispersive infrared detector/membrane equilibrator pCO₂ sensor in cooperation with the sensor manufacturer Franatech AS, and a spectrophotometric carbonate ion sensor based on the lab benchtop technique described by Byrne and Yao (2008). Seawater samples are also collected manually from the FerryBox system for determination of total alkalinity and total dissolved inorganic carbon using conventional titrimetric and coulometric techniques, respectively, back in the lab.

Another group of sensors that have been under development is related to phytoplankton ecology. In addition to using chlorophyll a fluorescence sensors to estimate phytoplankton biomass, a point source integrated cavity absorption meter (PSICAM)-based sensor can give information about phytoplankton pigment concentration and therefore functional groups, as well as total suspended material and colored dissolved organic matter (Wollschlager *et al.*, 2013). A flow-through sensor based on the PSICAM principle (that operates between ~360-750 nm) has recently been acquired to operate on the Barents Sea opening FerryBox as part of the Horizon 2020 Integrated Arctic Observation System (INTAROS) project.

Finally, due to the proximity of human activities to coastal waters, and the far and wide footprint of human activities, there has been a push to increase our observational capacity for contaminants and marine litter such as microplastics. Through the FP7 JERICO and MARine environmental in situ Assessment tool BOX (MARIABOX) projects, and the Horizon 2020 JERICO-NEXT and INTAROS projects, we have been cooperating with collaborators to develop and deploy contaminant samplers/sensors and high-volume microplastics samplers alongside our FerryBox systems. Prototype passive sampler systems have been developed (e.g., Brumovsky *et al.*, 2016), and new contaminant/toxin biosensors are currently under development.

Acknowledgements

We are thankful for funding from the NIVA Strategic Research Initiatives (OASIS and LOI-SIS), the Norwegian Environment Agency, the FRAM Centre Ocean Acidification Flagship, and the European Commission FP7 and Horizon 2020.

References

- Ainsworth C. (2008). FerryBoxes begin to make waves. *Science*, 332, 1627-1629.
- Brumovsky M., Bečanová J., Kohoutek J., Thomas H., Petersen W. Sørensen K., Sanka O., Nizzetto L. (2016). Exploring the occurrence and distribution of contaminants of emerging concern through unmanned sampling from ships of opportunity in the North Sea. *Journal of Marine Systems*, 162, 47-56 .doi: 10.1016/j.jmarsys.2016.03.004.
- Byrne R. H. and Yao W. (2008). Procedures for measurement of carbonate ion concentrations in seawater by direct spectrophotometric observations of Pb(II) complexation. *Marine Chemistry*, 112, 128-135.
- Reggiani E., King A.L., Norli M., Jaccard P., Sorensen K. and Bellerby R.G.J. (2016). FerryBox-assisted monitoring of mixed layer pH in the Norwegian Coastal Current. *Journal of Marine Systems*, 162, 29-36. doi: 10.1016/j.jmarsys.2016.03.017.
- Wollschläger J., Grunwald M., Rottgers R. and Petersen W. (2013) Flow-through PSICAM: a new approach for determining water constituents absorption continuously. *Ocean Dynamics*, 63, 761-775.

NOVEL BIOGEOCHEMICAL SENSORS: OPERATION OF A NEWLY DEVELOPED TOTAL ALKALINITY (TA) ANALYSER IN COMBINATION WITH A FERRYBOX FOR BETTER QUANTIFICATION OF THE CARBON DYNAMICS IN THE NORTH SEA

Y.G. Voynova⁽¹⁾, W. Petersen⁽¹⁾, M. Gehrung⁽¹⁾, and S. Assmann⁽²⁾

⁽¹⁾ Helmholtz-Zentrum Geesthacht, Institute of Coastal Research, Germany, wilhelm.petersen@hzg.de

⁽²⁾ Kongsberg Maritime Contros GMBH, Germany

Abstract

The North Sea is thought to be a site of efficient pumping of carbon dioxide from the atmosphere to the North Atlantic Ocean; however more measurements are necessary to fully understand the carbon cycling in this region. In addition to salinity and temperature, the variability in the carbonate system, necessitates high-frequency measurements of at least two of the carbonate system parameters: dissolved inorganic carbon (DIC), total alkalinity (TA), pH or pCO₂. FerryBoxes have been successfully used over the past years to continuously measure pH and pCO₂ along different sections of the North Sea. However, due to the low precision of standard pH sensors and the strong negative correlation of pCO₂ and pH, the combination of TA and pCO₂ measurements will give more reliable data about the total carbon budget.

Within the EU project NEXOS, currently in progress, a newly developed autonomous flow-through TA analyser has been extensively tested and optimized in cooperation with the manufacturer (KM CONTROS).

For the first time such a TA analyser has been successfully installed alongside a FerryBox aboard a cargo ship travelling between Cuxhaven (DE) and Immingham (UK). This flow-through TA instrument combined with continuous pH and pCO₂, salinity, dissolved oxygen, CDOM and chlorophyll fluorescence measurements will provide better insights in the North Sea carbon cycling. Initial results will be presented and discussed. Combined with dissolved oxygen, these measurements can be used to quantify carbon fluxes and primary production in surface waters.

Keywords: Total alkalinity, carbonate system, North Sea, FerryBox, ships of opportunity

1. Introduction

In addition to salinity and temperature, the variability in the carbonate system, necessitates high-frequency measurements of at least two of the carbonate system parameters: dissolved inorganic carbon (DIC), total alkalinity (TA), pH or $p\text{CO}_2$. FerryBoxes have been successfully used over the past years to continuously measure pH and $p\text{CO}_2$ along different sections of the North Sea. However, due to the low precision of standard pH sensors and the strong negative correlation of $p\text{CO}_2$ and pH, the combination of TA and $p\text{CO}_2$ measurements will give more reliable data about the total carbon budget.

The North Sea is thought to be a site of efficient pumping of carbon dioxide from the atmosphere to the North Atlantic Ocean; however more measurements are necessary to fully understand the carbon cycling in this region. The North Sea is a semi-enclosed marginal sea of the Atlantic Ocean with an average depth of 70m and a volume of 42000 km³ (Otto, 1990). The German Bight, located in the southeast North Sea, is a very dynamic region, influenced by outflow from major rivers like the Elbe River, outflow from the tidal flats and marshes within the Wadden Sea and coastal processes like winds, tides, residual circulation of the North Sea. Kempe and Pegler (1991) demonstrated that in the late spring and early summer, the lowest $p\text{CO}_2$ values within the North Sea, were measured in the German Bight, just north of the East Frisian Islands of the Wadden Sea. A detailed study of the carbon dynamics in this region could allow for better understanding of the carbon budgets and seasonal dynamics of the carbonate system in coastal areas flanked by tidal flats and lagoonal systems. Within the EU project NEXOS, currently in progress, a newly developed autonomous flow-through TA analyser has been extensively tested and optimized in cooperation with the manufacturer (KM CONTROS). Our study reports the preliminary results from this study obtained since the beginning of 2017.

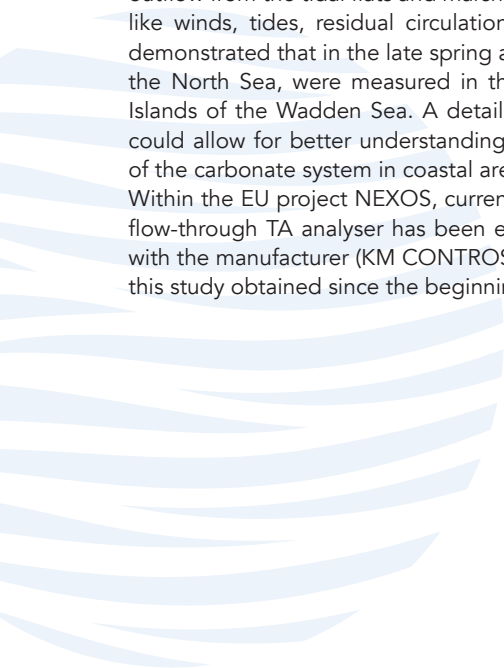

2. Methods

Oceanographic data were collected via a FerryBox installed aboard the cargo vessel (CV) Hafnia Seaways, travelling in the North Sea along two main routes defined as the North and South route in Fig. 1 (left panel). Since the beginning of 2017, the Hafnia Seaways travelled predominantly along the North route (see Fig. 1), and thus only the more complete data plots along this route were presented in the study. The data collected along the South route however have been extremely useful for example to determine whether there was a gradient in biogeochemical parameters from the nearshore to the adjacent coastal German Bight waters.

A flow-through FerryBox (Petersen *et al.* 2014) has been operated between Cuxhaven and Immingham since 2006, initially on board the Tordania and then on board the Hafnia Seaways cargo vessels. Every 10 seconds, the FerryBox measures temperature and salinity (Falmouth Scientific Inc. (FSI), Cataumet, MA and Teledyne Instruments, Poway, CA, USA), dissolved oxygen (DO; Aanderaa optode, Xylem Analytics, Waldheim, Germany), chlorophyll fluorescence (Chl, ECO FLNTU, Seabird Scientific, Philomath, OR, USA), pH (Meinsberg Clark electrode, Xylem Analytics, Waldheim, Germany and Honeywell Durafet electrode, Honeywell International – HPS, Phoenix, AZ, USA), partial pressure of carbon dioxide ($p\text{CO}_2$, Kongsberg Maritime Contros GmbH, Kiel, Germany).

Total alkalinity was measured using the Contros Hydro-FIA TA flow-through system (Kongsberg Maritime Contros GmbH, Kiel, Germany) starting in March, 2017. In the flow-through setup, sample water diverted from the main flow was passed through a cross-flow filter, which filtered water in a collection tube, which was then connected to the TA system intake. Timing of the sample intake and measurements was tested during the first two months of deployment, and following these tests, it was decided that sampling every 10 min (the sample measurement routine is about 6.5 min) was sufficient to properly capture the total alkalinity patterns along this route. Following recipe provided by the manufacturer, reagents were made in the laboratory, using bromocresol green salt for the indicator dye solution and 12M hydrochloric acid for the titration solution. After each reagent change, the instrument was recalibrated using a certified reference material provided Andrew G. Dickson laboratory; reagents were usually replaced every 6 weeks.

3. Preliminary results

The lowest salinities along the North route were measured in late spring-early summer (April-July) between 6-8°E, suggesting the influence of local rivers, like the Elbe, Ems, and even perhaps the Rhine River (Fig. 2). Total alkalinity did not follow this pattern, which suggests that it was influenced by other sources or sinks (Fig. 3). Seasonally, alkalinity increased along the entire transect and particularly in the region north of the Wadden Sea (Fig. 1) from $< 2250 \mu\text{mol kg}^{-1}$ in March to $> 2400 \mu\text{mol kg}^{-1}$ in August. There was also a significant difference between the waters west and east of 4°E: in the east, alkalinity in the surface waters was about $200 \mu\text{mol kg}^{-1}$ higher (Fig. 3).

Biological production may be responsible for some of the total alkalinity changes: although pH and pCO_2 variations do not directly affect total alkalinity, nutrient assimilation and remineralization related to primary production and respiration can change alkalinity (Wolf-Gladrow *et al.* 2007). Therefore Figs 5-6 are useful in accounting for the regions of highest primary production. In 2017, the highest primary production ($\text{pCO}_2 < 350 \mu\text{atm}$, DO 120-130 % sat) was observed in the spring (April-May) along the whole transect. This increased production coincides with the highest chlorophyll fluorescence observed during this time (Fig. 7). In June-July, primary production was still high east of 4°E, and particularly in the 6-8°E regions. This was evident by low pCO_2 and high pH. In comparison, dissolved oxygen was more evenly distributed with surface waters along the entire transect experiencing supersaturation (DO $> 100 \%$). This suggests that waters along this route are productive in the spring-summer season.

Another factor, which may affect total alkalinity, is the distribution and cycling of organic matter. As a proxy for dissolved organic carbon variations, CDOM distribution (Fig. 8) differed from the other parameters: although there was some high CDOM observed in the region of lowest salinity (6-8°E), along most of the transect CDOM was highest in the summer.

4. Further studies

This study will require some more detailed examination of the total alkalinity measurements in comparison to discrete samples, currently in the process of being completed. In addition, a short overview of the total alkalinity measurements near each port revealed that a slight instrument drift may affect the first few (4-5) measurements of each transect. This seems to be connected to the time the instrument is left in standby at each port.

To understand the observed total alkalinity variations, a more comprehensive study is necessary, including quantifying the nutrient, dissolved inorganic and dissolved organic carbon variations in the nearby regions, like the Wadden Sea and the Elbe River.

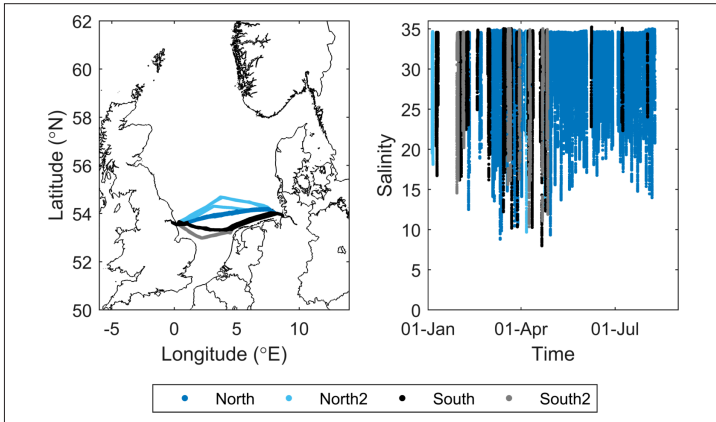

Fig. 1. Left panel: Hafnia Seaways routes in 2017 (01.01-07.08. 2017), divided by North (light and dark blue) and South (black and gray) transects (left panel). Right panel: Salinity distribution during this time (right panel). The gray and light blue transects indicate slight deviations from the typical North and South routes.

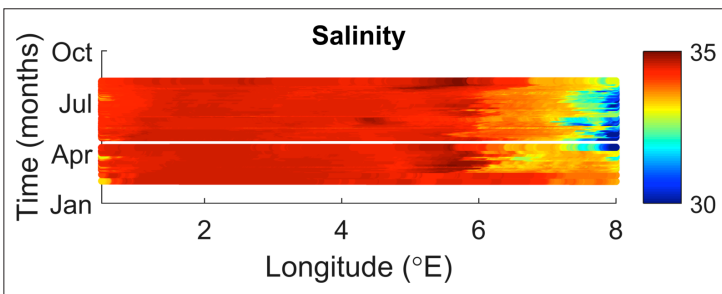

Fig. 2. Salinity measured along the North route (Fig. 1).

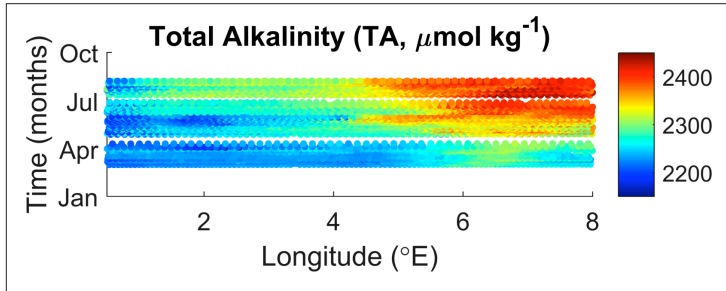

Fig. 3. Total alkalinity (TA) measured in $\mu\text{mol kg}^{-1}$ along the North route.

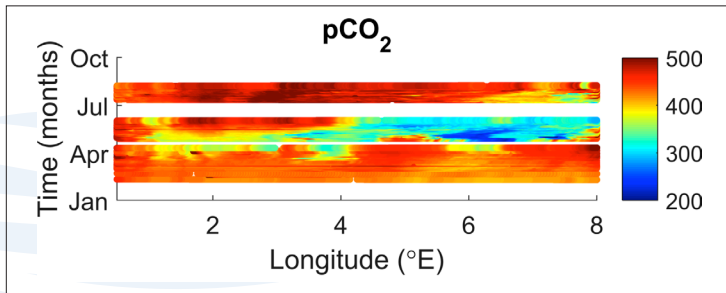

Fig. 4. Partial pressure of CO_2 (pCO_2) measured in μatm along the North route (Fig. 1).

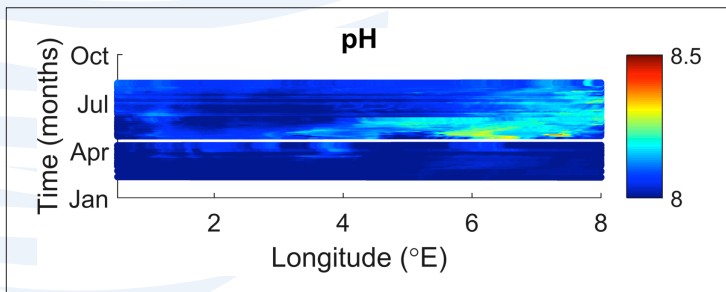

Fig. 5. pH measured along the North route.

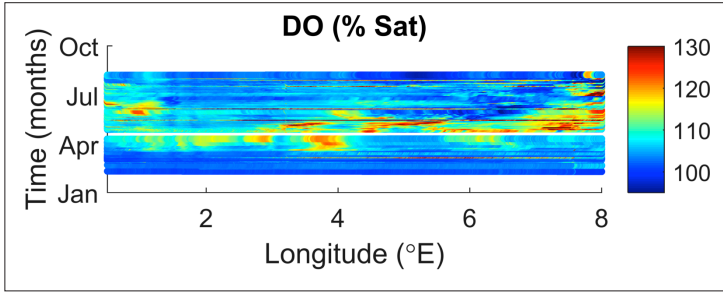

Fig. 6. Dissolved oxygen (DO) measured in % saturation along the North transect.

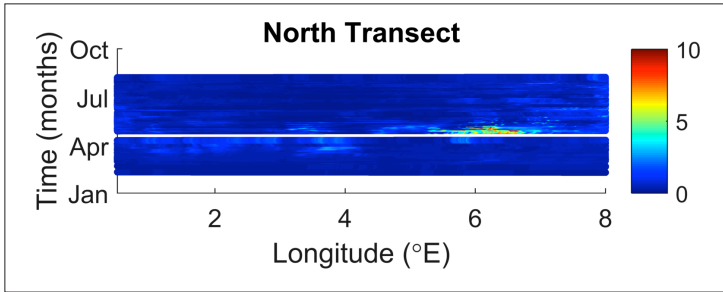

Fig. 7. Chlorophyll fluorescence (DO) measured in raw fluorescence along the North route (Fig. 1).

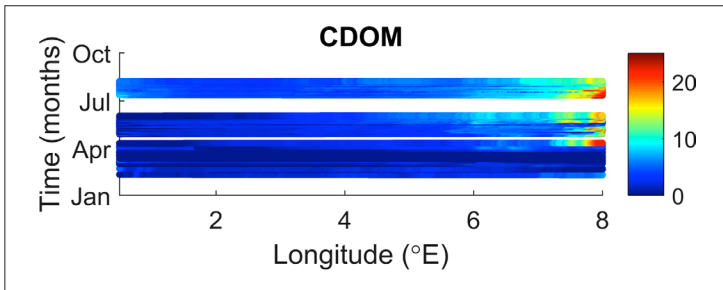

Fig. 8. Colored dissolved organic matter (CDOM) measured as fluorescence along the North route.

Acknowledgements

This research was partly supported by the EU projects NEXOS (Grant agreement no: 614102) and JERICO-NEXT (Grant agreement no: 654410). We thank the company DFDS Seaways (Copenhagen, Denmark) for the possibility of operating the FerryBox on board cargo vessel "Hafnia Seaways" and gratefully acknowledge the support by the ship's crew.

References

Kempe S., and Pegler K. (1991). Sinks and sources of CO₂ in coastal seas: the North Sea. *Tellus*, 43B, 224-235.

Otto L. Zimmerman J.T.F. Furnes G.K., Mork M., Saetre R. and Becker G. (1990). Review of the physical oceanography of the North Sea. *Netherlands Journal of Sea Research*, 26(2-4), 161-238.

Petersen W. (2014) FerryBox systems: State-of-the-art in Europe and future development. *Journal of Marine Systems*, 140, 4-12.

Wolf-Gladrow D.A., Zeebe R.E, Klaas C., Körtzinger A. and Dickson A.G. (2007), *Marine Chemistry*, 106, 287-300.



GLOBCURRENT: A PRE-OPERATIONAL MONITORING SYSTEM FOR SURFACE CURRENT AND UPPER OCEAN DYNAMICS BASED ON SENSOR SYNERGY

J.A. Johannessen ⁽¹⁾, B. Chapron ⁽²⁾, F. Collard ⁽³⁾, M.-H. Rio ⁽⁴⁾, J.-F. Piollé ⁽²⁾, L. Gaultier ⁽³⁾, G. Quartly ⁽⁵⁾, J. Shutler ⁽⁶⁾, R. Escola ⁽⁷⁾, R. P. Raj ⁽¹⁾, C. Donlon ⁽⁸⁾, R. Danielson ⁽¹⁾, A. Korosov ⁽¹⁾, F. Nencioli ⁽⁵⁾, M. Roca ⁽⁷⁾ and M. Hansen ⁽¹⁾

⁽¹⁾ NERSC, Bergen, Norway, johnny.johannessen@nersc.no

⁽²⁾ IFREMER, Plouzané, France

⁽³⁾ OceanDataLab, Locmaria-Plouzané, France

⁽⁴⁾ CLS, Toulouse, France

⁽⁵⁾ Plymouth Marine Laboratory, Plymouth, UK

⁽⁶⁾ University of Exeter, UK

⁽⁷⁾ isardSAT, UK

⁽⁸⁾ ESA ESTEC, Noordwijk, The Netherlands

Abstract

The GlobCurrent project (<http://www.globcurrent.org>) aims to advance the quantitative estimation of ocean surface currents from combined use of satellite and in situ sensor synergy. It is demonstrated that sharp gradients in the sea surface temperature, the sun-glint, the surface current and the ocean chlorophyll-a distribution are often spatially correlated with the sea surface roughness anomalies across a wide range (1-100 km) of spatial scales. Such expressions of 2-dimensional surface structures represent evidence of the dynamics in the upper (~100-200 m) ocean. In this presentation we will demonstrate that systematic utilization of sensor synergy integrated into an advanced visualization platform strengthen the ability to study sub-mesoscale to mesoscale processes associated with upper ocean dynamics. As such, it is also highly valuable for regular intercomparison and validation of ocean models.

Keywords: GlobCurrent project, sensor synergy, surface current, dynamics

1. Introduction

Thanks to satellite and in situ observations combined with high resolution numerical ocean models new knowledge and view of the global ocean surface dynamics filled with a large number of various mesoscale (~30-100 km) and sub-mesoscale (<~3-10km) meandering surface current features and eddies has emerged during the

last decade. However we are still faced with challenges when it comes to process understanding and accurate quantification of the surface current associated with these features. Nor is it always possible to provide forecasts of the exact locations and evolution of the frontal features and eddies with sufficient accuracy. This deficiency results primarily from inability to adequately characterize the upper ocean dynamics at fine spatial resolution. This is partly resulting from a lack of regular high-quality in situ observations with sufficient temporal and spatial resolution. However, more consistent quantitative use of satellite observations is also required to advance the understanding and reduce the knowledge gaps. The GlobCurrent project (<http://www.globcurrent.org>) is anchored on this fundamental view (Johannessen *et al.*, 2016). The overall objective of the project is: to advance the quantitative estimation of ocean surface currents from satellite sensor synergy and demonstrate impact in user-led scientific, operational and commercial applications that, in turn, will increase the uptake of satellite measurements.

To accomplish this multi-variable observations from past and presently operating remote sensing satellites have been consistently and systematically explored in a synergetic approach. As such, satellite-based high-resolution sea surface temperature, ocean color, sun glint, surface roughness and range Doppler observations ensure highly complementary information of the two-dimensional surface current structures and dynamics (Shutler *et al.*, 2016). Hence, it makes sense to regularly collocate and combine these observations with coarser resolution sea surface height measurements from altimetry as illustrated in Fig. 1 linking platforms, sensors, variables and derived surface current types. From the radar altimeter, infrared radiometer and imaging spectrometer (including sun glint) as now provided from Sentinel-3 one can obtain 6 geophysical variables, notably: small scale roughness anomalies, ocean color, sea surface height (SSH), significant wave height, near surface wind speed and sea surface temperature (SST). These variables and their spatial and temporal structure and changes contain direct or indirect manifestations of the surface current conditions, notably: surface current boundaries; surface tracer velocity; surface Ekman current; inertial motion; surface current vorticity; surface geostrophic current and Stokes drift.

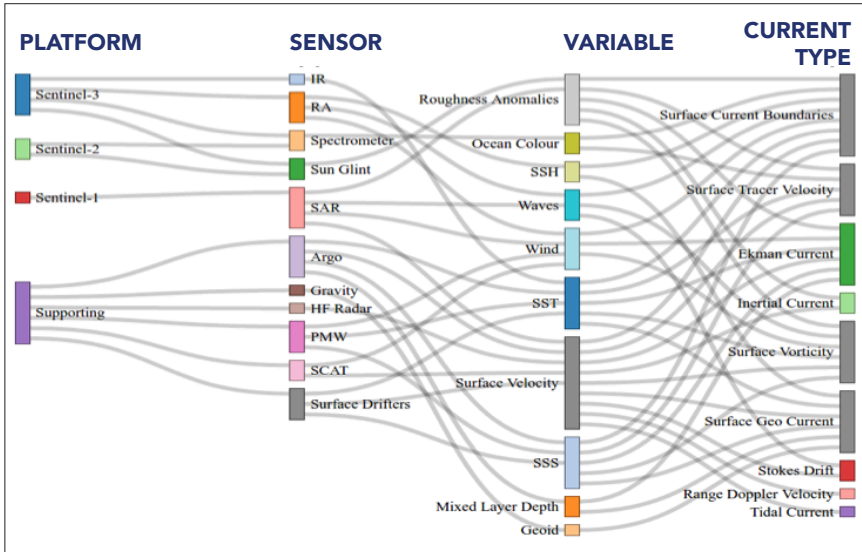

Fig. 1. Provision of data and information products from the Sentinels in support to the global, regional and local surface current estimations. Additional provision of complementary data and information from other missions and in situ data further demonstrates the importance and strength of the systematic use of sensor synergy. temperature (blue dots), salinity (green dots) and sound level (orange dots).

Invoking additional data and information products from Sentinel-1 SAR and Sentinel-2 high resolution spectrometer as well as other supporting satellite missions jointly with data from *in situ* observing systems (e.g. surface drifters, Argo profiling floats) increase the number of derived ocean variables as seen in Figure 1. In turn, more complementary information on the surface current conditions can be derived. Systematic use of satellite sensor synergy combined with *in situ* data is therefore strengthening and improving the ability to obtain high quality and consistent information on surface current conditions at scales from several km to hundreds of km. It also provides a mean for investigating relationship to the upper ocean (~100 m) dynamics and processes as demonstrated in the GlobCurrent project.

2. Data and methods

The GlobCurrent data (available for downloading at <http://www.globcurrent.org>) contains offline global and Mediterranean Sea data from 1993 to 2016. The global data has a $1/4^\circ$ grid resolution and includes: - 3 hourly and daily mean Ekman current at the surface and at 15m; - daily surface geostrophic current; and 3 hourly and daily mean total (geostrophic + Ekman) current at the surface and at 15m (Rio *et al.*, 2014). Comparably, the Mediterranean Sea data has a $1/8^\circ$ grid resolution with the following components: - 6 hourly and daily mean Ekman current at 15m; - daily surface geostrophic current; and 6 hourly and daily mean total (geostrophic + Ekman) current at 15m. In addition, there is a near real time GlobCurrent data product at a $1/4^\circ$ resolution from the 15th of March 2016 to present, including: - 6-hourly and daily mean Ekman current at 15m; - daily mean surface geostrophic current; and daily mean total (geostrophic + Ekman) current at 15m. The current fields are furthermore combined and collocated with satellite-based sea surface temperature fields at a daily timescale and 10km spatial resolution. Finally, these collocated fields of SST and currents are also regularly combined and blended with “snapshot satellite images” including ocean colour data, sunglint observations and SAR roughness anomaly as well as surface drifter data (Lumpkin and Johnson, 2013) and Argo profiling floats.

The GlobCurrent products can be visualized using the data portal <http://globcurrent.oceandatalab.com>. Selecting from a “Products” menu and timeline different viewing options the global and Mediterranean Sea data to be collocated and overlaid. In addition, when selecting drifter trajectories, for instance, one month of trajectory is shown related to the selected month and with a diamond shape indicating the position of the drifter at the selected time. The ability to display these trajectories on top of the near coincident SST and surface current maps as shown in Fig. 2 clearly demonstrates the strength of this visualization platform both for research and dedicated applications including planning and execution of field campaigns.

The use of the visualization platform moreover allow efficient combination and overlays of the surface geostrophic current and SST field with other high-resolution snapshot images such as the Sentinel-1 SAR surface roughness image and the radar altimeter tracks centred to 23 March 2015 as shown in Fig. 3. This allow further investigation of the multiple types of 2-D surface signal expressions and their relationship to mesoscale processes and upper ocean dynamics as demonstrated by Kudryavtsev *et al.*, (2012) and Rasche *et al.*, (2017).

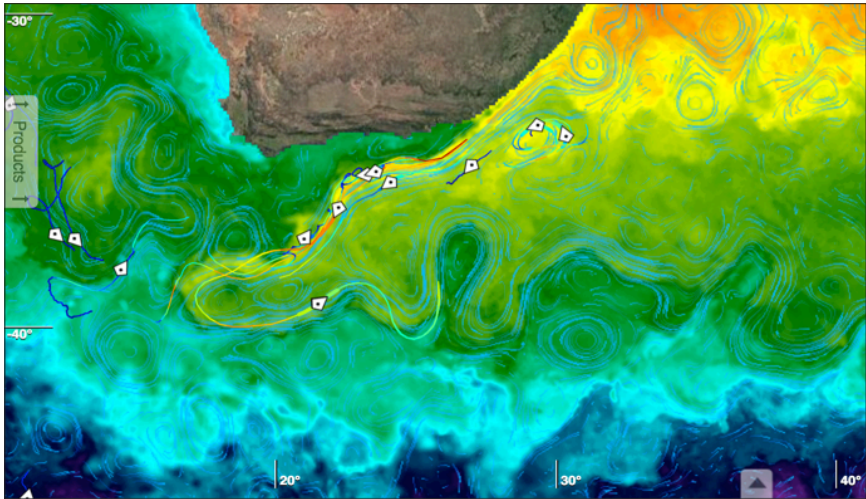

Fig. 2. Zoom in the greater Agulhas Current region with GlobCurrent geostrophic current component as blue streamline overlaid on a ODYSSEA SST map (color) and with the drifter trajectories indicated with colors representing different speed ranges.

An updated drifter dataset downloaded from the Surface Drifter - Data Assembly Center (SD-DAC) at AOML (<http://www.aoml.noaa.gov/phod/dac/dacdata.php>) has been used for validating the GlobCurrent products (Danielson *et al.*, 2016). These data cover the period January 1993-December 2015, and include separated fields with 15m drogued and undrogued drifters. At the surface, the YOMAHA surface velocities based on Argo floats from 1997 to 2015 are used as reference. In addition high-resolution satellite sensor synergy (e.g., optical glitter, roughness anomalies) is used on a case-by-case basis as illustrated in Fig. 3. It is found that the best results are obtained using the GlobCurrent based total geostrophic + Ekman current at both the surface and at 15m depth (Rio, personal communication). The visualization platform furthermore allows for evaluation of fields and identification of inconsistency in the products. For instance, due to the lack of temporal resolution in altimeter data, the retrieved surface geostrophic velocities are not always consistent with the daily updated SST field. This has prompted the development of methods to constrain and align the altimeter-based surface geostrophic velocity vector along SST fronts where the geostrophic assumption is valid (Rio *et al.*, 2016).

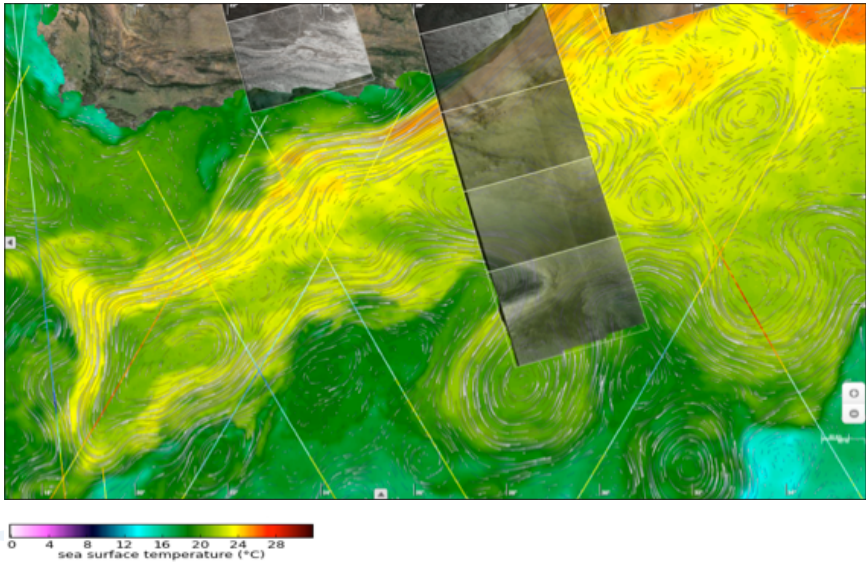

Fig. 3. The combined SST and surface geostrophic current (stippled streamlines) field together with a snapshot surface roughness map from the Sentinel-1 SAR image obtained on 23 March 2015. The altimeter track data are overlaid. The color bar gives the SST in degree Celsius.

3. Summary

Both delayed time and near real time current products have been calculated in the framework of the GlobCurrent project for the global oceans and for the Mediterranean Sea for the period 1993-2017. These products are now considered to be routine (see Table I) and ready for transition into CMEMS-phase II. It is therefore expected that they will be made available both as delayed mode and near-real time products from May 2018.

Table I. Status of the GlobCurrent routine and R&D products.

PRODUCT	AVAILABILITY
Global surface geostrophic velocity	Routine
Global Ekman term	Routine
Total (geostrophic + Ekman) current	Routine
Regional surface geostrophic currents (Mediterranean Sea)	Routine
Regional Ekman currents at 15m (Mediterranean Sea)	Routine
Regional total currents at 15m (Mediterranean Sea)	Routine
Drifter and Argo float match-ups	Routine
Current gradient from swell reflection	R&D
Velocity Projection	R&D
Frontal sharpening	R&D
Eddy tracking	R&D
Range Doppler shift retrievals	R&D
Lagrangian diagnostics	R&D

Moreover, there are a number of highly important complementary research and development activities and tools (as indicated in Table I) such as wave-current interaction and refraction, velocity projections, frontal sharpening, automated range Doppler velocity retrievals, eddy tracking and Lagrangian diagnostics. Sustaining these R&D activities may subsequently evolve towards later important uptake by CMEMS. Altogether the key scientific findings and major achievements from the GlobCurrent project will be published in a special issue on "Advances in the Science of Surface Currents" to appear in Remote Sensing of the Environment (RSE) with expected publication in August 2018.

Acknowledgements

This study was performed in the framework of the European Space Agency (ESA) funded GlobCurrent project under the Data, Utilization and Exploitation (DUE) program with contract number: 4000109513/13/I-LG. The data presented in this study can be downloaded from the following website <http://www.globcurrent.org>.

References

- Danielson, R., A. Korosov, J.A. Johannessen, R. Raj, M.H. Rio, F. Collard, B. Chapron, G. Quartly, J.F. Piolle, A regional characterization of the GlobCurrent ocean surface current analyses, *Proceedings of Living Planet Symposium 2016*, SP-740.
- Johannessen, J.A., B. Chapron, F. Collard, M.-H. Rio, J.-F. Piollé, L. Gaultier, G. Quartly, J. Shutler, R. Escola, R. P. Raj, C. Donlon, R. Danielson, A. Korosov, F. Nencioli, V. Kudryavtsev, M. Roca, J. Tournadre, G. Larnicol, G. Guitton, P. Miller, M. Warren and M. W. Hansen, GlobCurrent: Multisensor synergy for surface current estimation, *Proceedings of Living Planet Symposium 2016*, SP-740.
- Kudryavtsev, V. N. A. Myasoedov, B. Chapron, J. A. Johannessen, F. Collard (2012), Imaging mesoscale upper ocean dynamics using SAR and optical data, *Journal of Geophysical Research*, Vol. 117, C04029.
- Lumpkin, R., and G. C. Johnson, 2013, Global ocean surface velocities from drifters: Mean, variance, El Niño–Southern Oscillation response, and seasonal cycle, *J. Geophys. Res. Oceans*, 118, 2992–3006.
- Rasclé N., J. Molemaker, M. Louis, F. Nougier, B. Chapron, B. Lund, A. Mouche (2017), Intense deformation field at oceanic front inferred from directional sea surface roughness observations. *Geophysical Research Letters*, (in press), <http://doi.org/10.1002/2017GL073473>
- Rio, M.-H., S. Mulet and N. Picot (2014) Beyond GOCE for the ocean circulation estimate: Synergetic use of altimetry, gravimetry, and *in situ* data provides new insight into geostrophic and Ekman currents, *Geophys. Res. Lett.*, 41, doi:10.1002/2014GL061773.
- Rio, M-H, R. Santoleri, R. Bourdalle-Badie, A. Griffa, L. Piterberg, G. Taburet (2016) Improving the altimeter derived surface currents using high-resolution Sea Surface Temperature data: A feasibility study based on model outputs. *Journal of Atmospheric and Oceanic Technology*, Vol. 33, DOI: 10.1175/JTECH-D-16-0017.1.
- Shutler J.D., Quartly G.D., Donlon C.J., Sathyendranath S., Platt T., Chapron B., J.A. Johannessen, F. Girard-Ardhuin, P.D. Nightingale, D.K. Woolf and J.L. Høyer. (2016) Progress in satellite remote sensing for studying physical processes at the ocean surface and its borders with the atmosphere and sea ice. *Progress in Physical Geography*, 40(2):215–46. doi: 10.1177/0309133316638957

EURO-ARGO IN WORK AND NEW POTENTIAL OF GLIDERS IN THE BALTIC SEA BOOS

P. Alenius⁽¹⁾, K. Tikka⁽¹⁾, U. Lips⁽²⁾, L. Tuomi⁽¹⁾, T. Purokoski⁽¹⁾, P. Roiha⁽¹⁾ and S. Siirä⁽¹⁾

⁽¹⁾ Finnish Meteorological Institute, P.O.Box 503, FI-00101 Helsinki Finland, pekka.alenius@fmi.fi

⁽²⁾ Department of Marine Systems, Tallinn University of Technology, Akadeemia tee 15a, 12618 Tallinn, Estonia

Abstract

Argo-floats are part of the Finnish Meteorological Institutes (FMI) routine monitoring of the Baltic Sea since 2012. As Finland is a partner of Euro-Argo ERIC, FMI maintains Argo-floats in the North Atlantic and in the Baltic Sea. FMI has kept Argo-float continuously in the central Baltic Sea and in the Bothnia Sea, a sub-basin of the Baltic Sea. These floats measure CTD profiles once a week. FMI recovers and replaces them once a year and reuses the floats after maintenance service.

FMI was a partner in European glider infrastructure project GROOM in 2011-2014 and showed the potential of gliders in the northern Baltic Sea. FMI has used a Slocum G2 shallow water glider since 2016 in research projects. Department of Marine Systems (MSI) of Tallinn University of Technology has used a similar glider already since 2015. In May 2017 FMI and MSI had the first joint two-glider experiment in the Baltic Sea. The gliders worked together in a project on water exchange between the Baltic Sea Proper and the Gulf of Bothnia. Both institutes have already earlier demonstrated that gliders are very potential instruments for monitoring the shallow Baltic Sea.

Keywords: Argo float, ocean glider, BOOS

1. Introduction

The Baltic Sea is a strongly stratified shallow semi-enclosed sea where seasonal variations of temperature are large. The population of the catchment area is over 80 million. The sea is partly heavily eutrophicated and the ship traffic is intensive. Because of its vulnerability and naturally low oxygen conditions of the deep waters in the Baltic Sea Proper, the Baltic Sea has been monitored for a long time. The international joint

monitoring of the environmental conditions has been well coordinated since the establishment of the permanent secretariat of HELCOM in 1979. In spite of the long monitoring traditions, some of the automatic means of monitoring that have been used in oceans have found their way to the Baltic Sea with a delay. These are the Argo floats and ocean gliders.

The Baltic Sea monitoring programs have been developed and made more cost effective during the years. FMI began to experiment with Argo floats in the Baltic Sea in 2011. Very soon it was noticed that with some modifications, the floats could well be used in the shallow waters, too. FMI developed practices to operate the floats permanently in the areas that do not freeze in winter and semi-permanently in areas where ice occurs in winter. The first long Argo-float experiment was done in the Bothnian Sea in 2012 and the operations in the Baltic Sea proper were started in August 2013.

The other branch of automatic vehicles, the gliders, is not yet used for regular monitoring in the Baltic Sea. After some earlier glider tests in German waters and southern Baltic Sea an ocean glider was tested in 2013 in the Bothnian Sea. Estonia got a glider in use in 2015 and Finland in 2016. Both countries have used glider in several research projects and also jointly. Regular monitoring by gliders is still a future option.

2. Argo-Floats in the Baltic Sea

FMI uses Teledyne Webb Research APEX buoys as its Argo-floats. Because the Baltic Sea is very small in vertical and horizontal dimensions, the floats cannot be left there without any consideration. Thus FMI has developed a way to monitor and adjust the float position and movement in a way, that allows keeping them within the desired monitoring areas throughout the experiments.

FMI's strategy is to keep the floats operative for a year after which they are replaced. Usually the recovering and deployment of the float is done during regular monitoring cruises of research vessel Aranda, but also other vessels can be used. The recovered floats go through maintenance service and then they are deployed again.

The temporal resolution of the CTD profiles that the Argo-float measure, can be adjusted. In the Baltic Sea, the CTD profiles are measured typically once a week. However, during some intensive monitoring campaigns, profiles can be taken even several times a day. The sampling interval may be changed during the deployment. This sampling strategy has proven to be good for the one-year operations. So far all the Argo missions and replacement operations have gone without problems.

Today FMI has had 10 missions in the Bothnian Sea three of which are active at the writing of this, five in the Baltic Sea Proper (Gotland Deep) (Fig. 1), one of which is active, and one new mission in the Bothnian Bay. The data from these missions is available from Coriolis (<http://www.coriolis.eu.org/Data-Products/Data-Delivery/Argo-floats-by-WMO-number>).

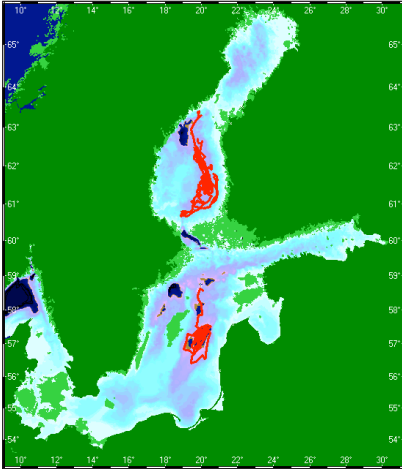

Fig. 1. Tracks (red lines) of FMIs Argo-floats in the Baltic Sea till June 2017.

Argo-data from the central Baltic Sea forms an almost continuous time series (Fig. 2). This gives extended possibilities to analyse the evolution of the conditions in the open-sea water column there and can be considered an important additional component of the international Baltic Sea monitoring.

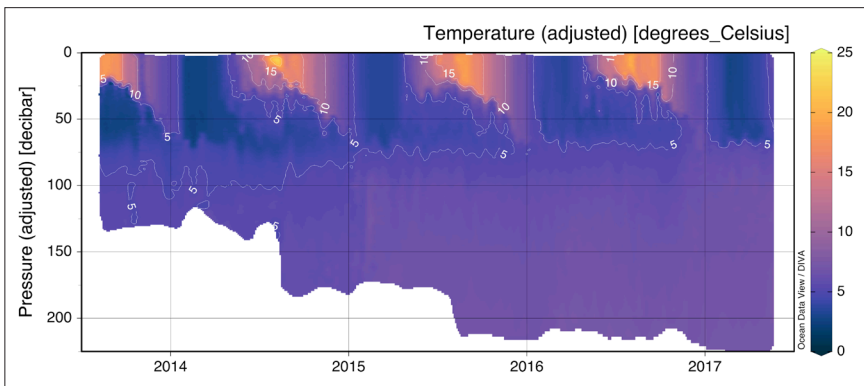

Fig. 2. Time evolution of the temperature in the central Baltic Sea seen from Argo-float data.

3. Gliders in the northern Baltic Sea

In the Baltic Sea area there have been some experiments with gliders in 2000's. Some of the experiments were less successful, but the Bocknis Eck mission gave some time series from the southern Baltic Sea (Karstensen *et al.*, 2014). EU funded infrastructure project GROOM (Gliders for Research, Ocean Observation and Management, <http://www.groom-fp7.eu>) in 2011-2014 aimed at building a Glider European Research Infrastructure (GERI) (see http://www.groom-fp7.eu/lib/exe/fetch.php?media=public:deliverables:groom_final_report_publishable.pdf).

FMI was invited to the project in order to encourage the use of gliders in the Baltic Sea. In that context FMI tested together with PLOCAN, Gran Canary, Spain, their ocean glider in the Bothnian Sea and Archipelago Sea in 2013. In addition to large number of deliverables on different aspects of glider usage, the GROOM community also analysed the potential of gliders in GOOS (Liblik *et al.*, 2016). FMI is also a member in EGO network (Everyone's Gliding Observatories). The goal of the network is to share efforts needed by glider data collection as a community, and support the dissemination of glider data in global databases in real-time and delayed mode for a wider community.

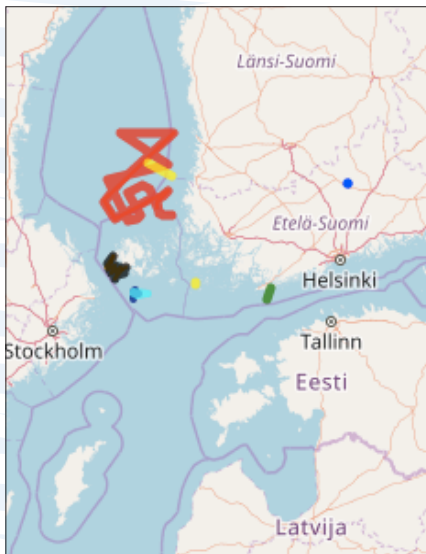

Fig. 3. FMI's glider missions since 2013.

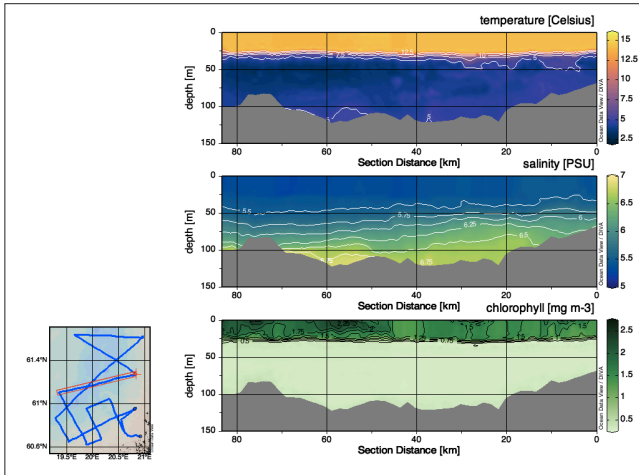

Fig. 4. An example of glider data from glider mission in the Bothnian Sea in autumn 2016.

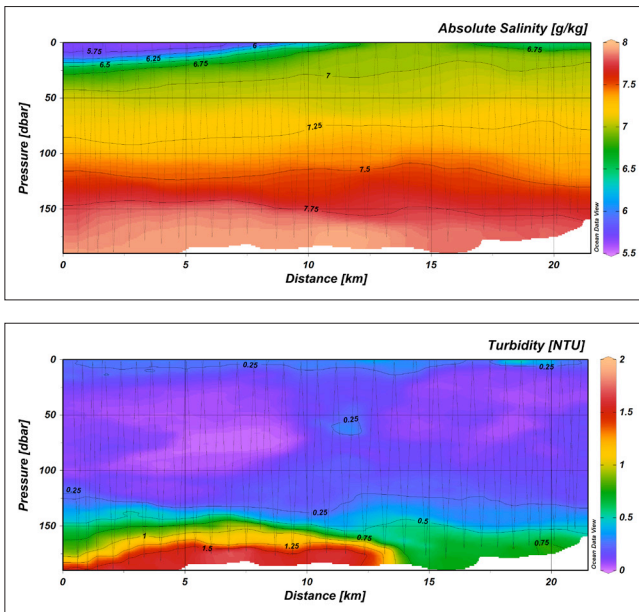

Fig. 5. Vertical sections of salinity and turbidity acquired from Estonian glider during the joint glider mission in May 2017 in the northern Baltic Proper.

MSI has used its glider in the Baltic Sea Proper and in the Gulf of Finland. FMI has conducted glider missions (Fig. 3) in the Gulf of Finland, Archipelago Sea, Åland Sea and Bothnian Sea (Fig. 4). FMI has also tested the glider for freshwater lake research in lake Pääjärvi in southern Finland. FMI and MSI are continuously developing the mutual co-operation in glider usage and had a joint mission in May 2017 (Fig. 5).

4. Summary

Routine use of autonomous underwater vehicles for monitoring the Baltic Sea has advanced somewhat behind that in the oceans, but the situation has rapidly changed during last five years. Experiences have shown that Argo-floats are a valuable addition to the traditional monitoring also in the shallow Baltic Sea. FMI is increasing the amount of active floats and Poland has had at least two Argo missions in the southern Baltic Sea.

Finnish and Estonian activities in glider usage are growing and though both countries have only one glider each, co-operation is advancing towards a mini glider-port. The EU-funded project GROOM was vital for advancement in glider usage in the Baltic Sea. The support from European glider community and co-operation with PLOCAN and SOCIB, Mallorca Spain has been of great value for FMI. FMI is a partner in Finnish Marine Research Infrastructure (FINMARI), which contributed a lot in getting the glider to FMI. Co-operation within EGO network hopefully leads to routine glider data processing and delivery to users as similar system than within Euro-Argo. The use of gliders in monitoring a small heavily trafficked sea that is divided to economic zones of several countries has challenges, but hopefully those are identified.

Acknowledgements

The support of prof. Laurent Mortier and Dr. Pierre Testor, leaders of GROOM, has been of great value as also the excellent co-operation with PLOCAN (C.Barrera) and SOCIB (J. Tintoré, M. Torner Tomás and E. Heslop) from Spain in setting up FMI's glider operations.

References

- Karstensen J., Liblik T., Fischer J., Bumke K. and Krahnemann G. (2014). Summer upwelling at the Boknis Eck time-series station (1982 to 2012) – a combined glider and wind data analysis. *Biogeosciences*, 11, 3603–3617.
- Liblik T., Karstensen J., Testor P., Alenius P., Hayes D., Ruiz S., Heywood K.J., Pouliquen S., Mortier L. and Mauri, E. (2016). Potential for an underwater glider component as part of the Global Ocean Observing System. *Methods in Oceanography*, 17, 50–82.
- Schlitzer, R., Ocean Data View, <https://odv.awi.de>, 2016.

CROSS-SHELF EXCHANGES IN THE BAY OF BISCAY

A. Akpınar⁽¹⁾, G. Charria⁽¹⁾, F. Vandermeirsch⁽¹⁾ and T. Szekely⁽²⁾

⁽¹⁾ LOPS/IFREMER, Technopôle de Brest-Iroise, BP 70, 29280 Plouzané, France, anil.akpinar@ifremer.fr

⁽²⁾ CORIOLIS, CNRS, Technopôle de Brest-Iroise, BP 70, 29280 Plouzané, France

Abstract

Cross-shelf exchanges in the Bay of Biscay are investigated utilizing various tools including in situ temperature and salinity profiles, satellite derived sea surface temperature and chlorophyll-a concentration and numerical simulations. Various eddy-induced cross-shelf transport events were detected following in situ and remotely sensed data. Identified eddy-induced transport events were further investigated using high resolution (1km) simulations. Important role of shelf-break (sub)mesoscale eddies and associated filaments on cross-shelf exchanges in the Bay of Biscay is documented. An example case is presented. This study constitutes a basis for the ongoing study, where the overall goal is to quantify these eddy-induced cross-shelf exchanges.

Keywords: Cross-shelf exchanges, Bay of Biscay, (sub)mesoscale, eddies, filaments

1. Introduction

Cross-shelf exchange is a crucially important pathway for nutrients, biota and materials determining their delivery and removal rates on the continental shelf (Brink, 2016). These exchanges are important for the carbon and nutrient budgets of the ocean (Huthnance *et al.*, 2002).

The Bay of Biscay is one of the key constituents of the Western European Continental Shelf in the North Atlantic, playing an important role in the interactions between the continental shelf and the open ocean waters. Narrow continental shelf in the southern part (~30km), extends to a wider continental shelf (~180km) off Brittany (Charria *et al.*, 2013). Together with internal tides and Ekman flow, this complex topography (and the canyons in it) strongly influences the continental slope current (Pingree and Garcia-Soto, 2014). This complex topography and the instability of the slope current may lead to a generation of coherent mesoscale structures (Charria *et al.*, 2017), such as the Slope Water Oceanic eDDIES (SWODDIES) (Pingree and Le Cann 1992a; Pingree and Le Cann 1992b; Garcia-Soto *et al.*, 2002; Caballero *et al.*, 2014). Despite the fact that the eddy generation and properties have been well documented in the southern

part of the Bay of Biscay, eddy activity in the north remains yet unclear with limited studies based on drifter data (Van Aken, 2002; Charria *et al.*, 2013). Despite the eddy generation mechanism in the north (similar to the south), related with the influence of topographic features and the instability of the slope current, another mechanism might be contributing to the eddy generation. Northern (north of 45°N) part of Bay of Biscay displays a fully developed frontal activity (Yekeçi *et al.*, 2017). The baroclinic instability of these fronts (particularly tidal fronts) might be an additional mechanism leading to eddy generation in the north (Badin *et al.*, 2009).

Albeit the circulation and hydrography in the Bay of Biscay has been well presented, there is limited knowledge on the cross-shelf exchanges in the region. Available knowledge is limited to suggestions of cross-shelf flows following drifter trajectories (Porter *et al.*, 2016) and modelling studies documenting cross-shelf flows of fresh shelf waters (Reverdin *et al.*, 2013). Quantification of the ocean-margin exchange has been limited to rough estimates (Huthnance *et al.*, 2002, 2009).

Cross-shelf exchange is a rather difficult problem to address, considering it is weak, not easy to observe and often ageostrophic (Brink, 2016). Despite the different processes (Ekman transport, bottom boundary-layer flows etc.) that might lead to cross-shelf exchanges (through violation of the Taylor-Proudman assumptions, Brink, 2016), in this study we are mainly interested in the (sub)mesoscale structures; eddies and associated filaments contributing to these cross-shelf exchanges.

Therefore, the main purpose of this study is to determine the eddy activity in the Bay of Biscay, its contribution to cross-shelf exchanges and in the end, quantification of the heat, salt and volume transports at the ocean margin.

2. Data and methodology

In situ vertical profiles of temperature and salinity used in this study are acquired from the Coriolis Ocean Dataset for Reanalysis for the Ireland-Biscay-Iberia region (CORA-IBI, Szekely *et al.*, 2017). CORA-IBI dataset contains observations from a variety of platforms including research/opportunity vessels (CTD, XBT, Ferrybox) and autonomous platforms (Argo floats, moorings, gliders, drifters and fishery observing system - RECOPECA program). CORA-IBI product supplies quality flags, which are assigned through statistical tests and visual quality controls (Szekely *et al.*, 2017).

Remotely sensed sea surface temperature (SST) data are night time Level 2 ungridded products with ~1km resolution available from Moderate Resolution Imaging Spectroradiometer (MODIS) sensor on Aqua and Terra satellites. Remotely sensed chlorophyll-a concentration with ~1km resolution for the North Atlantic Ocean are acquired through E.U Copernicus Marine Service Information (marine.copernicus.eu). Chlorophyll concentration is estimated using the OC5ci algorithm, a combination of

OCI (Hu *et al.*, 2012) and OC5 (Gohin *et al.*, 2008), using OCI for open/case-1 waters and OC5 for coastal/case-2 waters.

Outputs from two different configurations of the MARS3D model (Lazure *et al.*, 2009) have been used for this study. The first configuration is the configuration developed in the frame of the coastal operational oceanography project PREVIMER (Dumas *et al.*, 2014, <http://www.previmer.org>), running operationally (2006-ongoing), with 2.5km horizontal resolution, 40 sigma levels with hourly outputs. For details of the PREVIMER configuration, see Yelekçi *et al.* (2017) and references within. Second configuration of the MARS3D model used in this study is the outputs of BACH1000 simulations (Theetten *et al.*, 2017). This configuration is a hindcast (2001-2010) with 1km horizontal resolution, 40 sigma levels and daily outputs. For details of the BACH1000 configuration, see Charria *et al.* (2017) and Theetten *et al.* (2017). Outputs of these two configurations were compared with the remotely sensed products. Despite both configurations were able to simulate features with a resolution >20km, the PREVIMER configuration was not able to simulate smaller scale features, which constituted a considerable amount of the observed (sub)mesoscale activity on the shelf break. Therefore, in this abstract, results from the PREVIMER configuration are not shown.

In this study, we focus on the northern part of Bay of Biscay, particularly in two rectangular areas (first area bounded by 46oN-48oN and 4oW-8oW and second area by 45oN-47oN and 3oW-7oW). Selection of these areas were done considering the lack of knowledge in literature for this region (north of 45oN), the availability of *in situ* measurements and the observed (sub)mesoscale features (with possible role in cross-shelf exchanges) observed along the shelf-break in the region (from satellite images).

The area was further divided into 3 regions (Fig. 1), following a simple bathymetry criterion, as shelf waters (R3: water depth < 150m), shelf-break region (R2: 150 < water depth < 2500m) and open waters (R1: water depth > 2500m). *In situ* data were used to construct the monthly distribution of temperature and salinity in these 3 sub-regions. After obtaining these background states of temperature/salinity for the sub-regions, anomalies (not shown here) were obtained by simply subtracting the climatological means of each month (average of 2007-2014 for each month) from the corresponding month (e.g: Anomaly of March 2008 = March 2008 - March mean (2007-2014)).

In situ measurements were also used to detect possible imprints of cross-shelf exchanges, simply by investigating data clusters over the shelf-break region, and through individual Argo float transects which cross the shelf break. However, no clear sign of cross-shelf exchange was found. Therefore, satellite images of SST and CHL were carefully investigated for eddies and filaments over the shelf-break. Numerous features were detected. Model results (both configurations) were investigated and compared with the features observed through remote sensing. BACH1000 simulations were able to successfully simulate different types of shelf-break eddies and filaments. Observed features were further investigated using the model outputs, in order to obtain the mechanism behind the formation/dissipation of the features and their impact on the cross-shelf exchanges.

3. Results

In order to understand the general thermohaline characteristics in the region of interest, *in situ* temperature and salinity profiles were used to construct the background state. Fig. 1 represents the distribution of profiles in the domain of investigation. Here, temporal distribution of temperature (Fig. 2) is presented only for the first region (R1-open ocean) as an example. For all the regions, temperature fields represent the seasonal cycle and interannual variations clearly, whereas for salinity it was rather unclear due to high variability. Some of the observed temperature anomalies were associated with eddy activity (as seen by satellite images), whereas for salinity anomalies no direct link was found. Despite the high uncertainty (due to alternating number of observations over time), *in situ* profiles of temperature/salinity provided the climatological state of the region fairly well, constructing background knowledge for the numerical simulations.

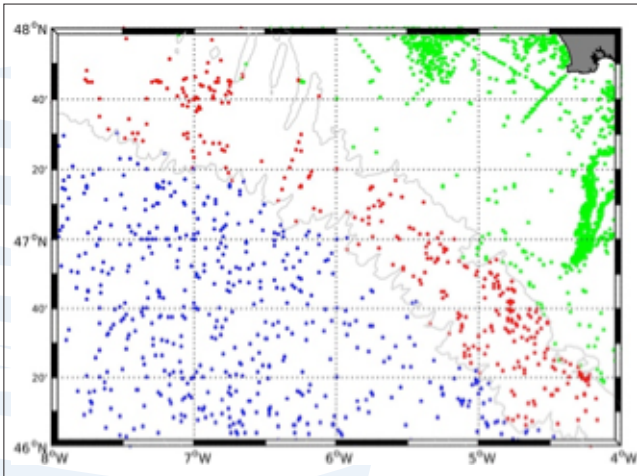

Fig. 1. Distribution of temperature/salinity profiles in the first rectangular area (2007-2014). Blue, red and green dots represent profiles in the open-ocean(R1) , shelf-break (R2) and coastal (R3) regions respectively.

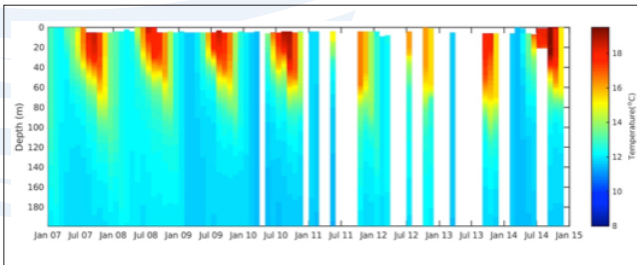

Fig. 2. Temporal evolution of temperature in region R1.

Satellite SST and chl-a concentration images were investigated carefully for eddies and filaments (leading to offshore transport) along the shelf break. We focused on 15 features in area-1, which were categorized in four groups as: cyclonic eddy, anticyclonic eddy, dipole of eddies and large-scale intrusion of cold water from the north. Observed features were further investigated with the outputs of numerical simulations.

Here we illustrate one example for the cross-shelf transport events: a cyclonic eddy and associated filament on the shelf break. On 20 May 2008, satellite chlorophyll concentration map (Fig. 3) suggests transport of high-chlorophyll offshore. Satellite SST (Fig. 4) for the same date also shows a cold filament exactly on the same location as the high-chlorophyll patch. BACH1000 model successfully simulated this feature (on 24 May 2008). The model was able to simulate the filament and associated eddy (Fig. 5). Gray and red lines in (Fig. 5 and Fig. 7) both represent the 46.1oN line, along which the sections were illustrated. The model also simulated the low salinity protrusion offshore (Fig. 6). Simulations suggested the total time for the formation, propagation and dissipation of this eddy took ~one month. Frequent generation of eddies were observed at this location, both in the satellite data and numerical simulations, which seems to be generated due to instabilities occurring around Sables d'Olonne Canyon (located at 46oN-4oW). The periphery of these eddies and the associated filaments displayed the strongest velocities (Fig. 7, Fig. 8) in the cross-shelf direction. For this particular day (Fig. 8), meridional velocity was ~0.15m/s along the filament. However, this filament reached ~0.4 m/s during its lifetime. These results highlight the important role of eddies in the shelf break. Their impact on the cross-shelf transports will be estimated.

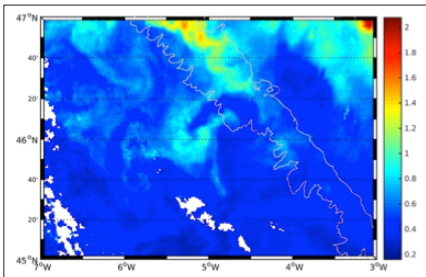

Fig. 3. Observed remotely sensed Chlorophyll concentration (in mg m^3) on 20 May 2008.

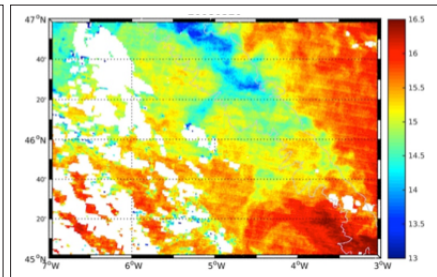

Fig. 4. Observed Sea Surface Temperature (in $^{\circ}\text{C}$) from MODIS-Aqua on 20 May 2008.

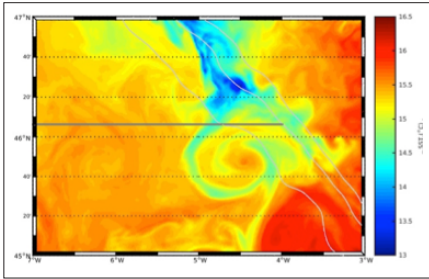

Fig. 5. Simulated Sea Surface Temperature on 24 May 2008.

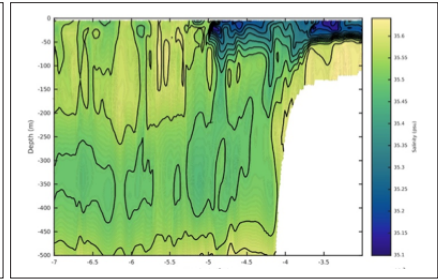

Fig. 6. Simulated salinity section along 46.1°N on 24 May 2008.

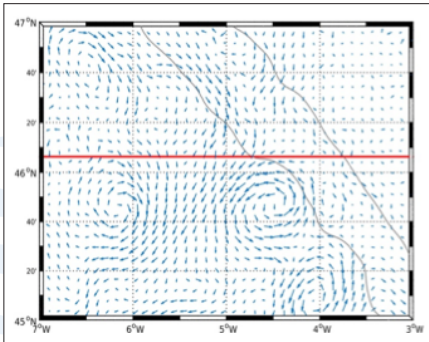

Fig. 7. Simulated surface circulation on 24 May 2008.

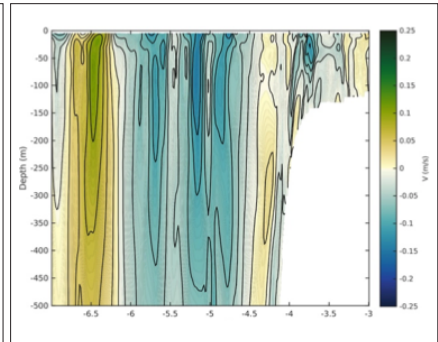

Fig. 8. Simulated meridional geostrophic velocity section along 46.1°N.

References

- Badin G., Williams R. G., Holt J. T., & Fernand, L. J. (2009). Are mesoscale eddies in shelf seas formed by baroclinic instability of tidal fronts? *Journal of Geophysical Research: Oceans*, 114(C10).
- Brink K. H. (2016). Cross-shelf exchange. *Annual review of marine science*, 8, 59-78.
- Caballero A., Ferrer L., Rubio A., Charria G., Taylor B. H. and Grima N. (2014). Monitoring of a quasi-stationary eddy in the Bay of Biscay by means of satellite, *in situ* and model results. *Deep Sea Research Part II: Topical Studies in Oceanography*, 106, 23-37.
- Charria G., Lazure P., Le Cann B., Serpette A., Reverdin G., Louazel S., ... and Morel Y. (2013). Surface layer circulation derived from Lagrangian drifters in the Bay of Biscay. *Journal of Marine Systems*, 109, S60-S76.
- Charria G., Theetten S., Vandermeirsch F., Yelekçi Ö. and Audiffren N. (2017). Interannual evolution of (sub) mesoscale dynamics in the Bay of Biscay. *Ocean Science*, 13(5), 777.
- Dumas F., Pineau-Guillou L., Lecornu F., Le Roux J. F. and Le Squire B. (2014). General Introduction: PREVIMER, a French pre-operational coastal ocean forecasting capability. *Mercator Ocean-Quarterly Newsletter*, (49), 3-8.
- Garcia-Soto C., Pingree R. D. and Valdés L. (2002). Navidad development in the southern Bay of Biscay: climate change and swoddy structure from remote sensing and *in situ* measurements. *Journal of Geophysical Research: Oceans*, 107(C8).
- Gohin F., Saulquin B., Oger-Jeanneret H., Lozac'h L., Lampert L., Lefebvre A., Riou P., and Bruchon F.: Towards a better assessment of the ecological status of coastal waters using satellite-derived chlorophyll-a concentrations, *Remote Sensing of Environment*, 112, 3329-3340, 10.1016/j.rse.2008.02.014, 2008.
- Hu C., Z. Lee and B.A. Franz (2012). Chlorophyll-a algorithms for oligotrophic oceans: A novel approach based on three-band reflectance difference, *J. Geophys. Res.*, 117, C01011, doi:10.1029/2011JC007395
- Huthnance J. M., Holt J. T. and Wakelin S. L. (2009). Deep ocean exchange with west-European shelf seas. *Ocean Science*, 5(4), 621-634.
- Huthnance J. M., Van Aken H. M., White M., Barton E. D., Le Cann B., Coelho E. F., ... and Vitorino J. (2002). Ocean margin exchange—water flux estimates. *Journal of Marine Systems*, 32(1), 107-137.
- Lazure P., Garnier V., Dumas F., Herry C. and Chifflet M. (2009). Development of a hydrodynamic model of the Bay of Biscay. Validation of hydrology. *Continental Shelf Research*, 29(8), 985-997.
- Pingree R. D. and Garcia-Soto C. (2014). Plankton blooms, ocean circulation and

the European slope current: Response to weather and climate in the Bay of Biscay and W English Channel (NE Atlantic). *Deep Sea Research Part II: Topical Studies in Oceanography*, 106, 5-22.

Pingree R. D. and Le Cann B. (1992). Anticyclonic eddy X91 in the southern Bay of Biscay, May 1991 to February 1992. *Journal of Geophysical Research: Oceans*, 97(C9), 14353-14367.

Pingree R. D. and Le Cann B. (1992). Three anticyclonic Slope Water Oceanic eDDIES (SWODDIES) in the southern Bay of Biscay in 1990. *Deep Sea Research Part A. Oceanographic Research Papers*, 39(7-8), 1147-1175.

Porter M., Inall M. E., Green J. A. M., Simpson J. H., Dale A. C. and Miller P. I. (2016). Drifter observations in the summer time Bay of Biscay slope current. *Journal of Marine Systems*, 157, 65-74.

Reverdin G., Marié L., Lazure P., d'Ovidio F., Boutin J., Testor P, ... and Rodriguez C. (2013). Freshwater from the Bay of Biscay shelves in 2009. *Journal of Marine Systems*, 109, S134-S143.

Szekely T., Bezaud M., Pouliquen S., Reverdin G. and Charria G.: CORA-IBI, Coriolis Ocean Dataset for Reanalysis for the Ireland-Biscay-Iberia region, SEANOE, <https://doi.org/10.17882/50360>, 2017.

Theetten S., Vandermeirsch F. and Charria G.: BACH1000_100lev-51 : a MARS3D model configuration for the Bay of Biscay, SEANOE, <https://doi.org/10.17882/43017>, 2017.

van Aken H. M. (2002). Surface currents in the Bay of Biscay as observed with drifters between 1995 and 1999. *Deep Sea Research Part I: Oceanographic Research Papers*, 49(6), 1071-1086.

Yelekçi Ö., Charria G., Capet X., Reverdin G., Sudre J. and Yahia H. (2017). Spatial and seasonal distributions of frontal activity over the French continental shelf in the Bay of Biscay. *Continental Shelf Research*, 144, 65-79.

OPERATIONAL WAVE HEIGHT MONITORING USING NAVIGATION BUOYS AND MARINE RADARS IN THE BALTIC SEA

T. Kõuts⁽¹⁾, S. Rikka⁽¹⁾, L. Käärman⁽²⁾ and A. Usk⁽³⁾

⁽¹⁾ Tallinn University of Technology, Tallinn, Estonia. tarmo.kouts@ttu.ee

⁽²⁾ Estonian Maritime Administration, Tallinn, Estonia

⁽³⁾ Cybernetica AS, Tallinn Estonia

Abstract

Operational measurements at sea get more importance as navigation aids and are becoming seen as a natural component in e-Navigation systems. Wave height is the most critical parameter for safe navigation at sea. Most commonly, wave buoys are used for measurements in real time mode. However, poor coverage and dependence on the ice situation are well known problems. We present methodology based on use of conventional navigational buoys as wave measurement instruments. Automated wave calculation algorithm WHAPAS (Wave Height and Period Software) was developed using high frequency motion data of the buoys as input. Calculated wave heights were validated with pressure based wave measurements near typical navigational buoys. Comparison results showed that that method captures local wave field peculiarities and pilot version of wave height network consisting 32 buoys at the Estonian coast showed good performance and stability during the test period.

The second part of the manuscript deals with marine radars. Unlike other remote sensing systems, marine radars cover smaller areas, but can obtain short-term temporal information about wave fields using consecutive antenna rotations. The method was developed and tested in Tallinn Bay, Gulf of Finland in the Baltic Sea, to derive wave height from the backscatter of the circularly polarized X-band marine radar.

Keywords: Operational oceanography, e-Navigation, wave measurements

1. Introduction

Tallinn bay is situated at the Gulf of Finland in the Baltic Sea (Fig. 1). Sea state in the Tallinn Bay is generally low and influenced by local wind speed and direction. However, the waves with the frequency up to 8 s can occur. High sea state in Tallinn Bay is mostly generated by western winds which yield to waves propagating into the bay from between the mainland and Naissaare island (Soomere and Rannat, 2003; Soomere, 2005). In turn, high sea state influences heavy ship traffic which occurs in Tallinn Bay (Soomere, *et al.* 2003).

The coastal Vessel Traffic Service (VTS) radar data is a good way to monitor sea state in high resolution over a sufficiently large area in relation to the size of the bay. Traditionally, the sea state parameters are received from coastal radar data using different inversion schemes (Hessner, *et al.* 2003; Dankert, *et al.* 2005; Ivonin, *et al.* 2016). The most widely known systems are Wamos I and Wamos II (Reichert, *et al.* 1999).

Most commonly, wave buoys are used for wave measurements in real time mode. However, poor coverage and dependence on the ice situation are well known problems. We present methodology based on the use of conventional navigational buoys and conventional marine radar as wave measurement instruments.

2. Data and methods

2.1 Radar and navigation buoy data and validation measurements

Coastal Vessel Traffic Services (VTS) radar data over Tallinn Bay area is acquired in collaboration with Estonian company Cybernetica AS. The radar is located at the Paljassaare peninsula (24.70753 °E, 59.48558 °N) with the tower high of 26 meters (27 – 28 meters from sea level). Radar antenna is working in X-band, 9374 ± 30 MHz frequency, and the signal is circularly polarized.

The radar images are rasterized to portable network graphics (PNG) format by Cybernetica AS with 5 by 5m pixel resolution with the range of about 10km. 64 consecutive images are transferred at the beginning of every full hour. The time resolution of the images is 3 seconds the same as the rotation rate of the antenna.

Tallinn Bay has a stationary wave gauge station called Vahemadal (at 24.666217 °E 59.510217 N) that is measuring sea state, current speeds, etc. all year around, which allows comparing radar-derived sea state with measured sea state.

On 18.10.2016, two additional mooring stations were deployed within the radar range to have wave height validation data. The buoys were installed different distances from radar tower to estimate incidence angle and shadowing effects. The closest buoy station to radar tower, at Paljassaare peninsula was deployed at 24.70325 °E, 59.49815 °N. The second additional buoy was installed close to Hülkari shallow at 24.6116 °E 59.539367 °N. The Hülkari buoy station is 8km away from radar tower and the image pixel values are expected to be most influenced by various effects of coastal radar, e.g. strong incidence angle and shadowing. Both additional buoys were installed approximately 2m below the sea surface. The validation phase lasted until 14.11.2016 with over 1600 collocation pairs between radar data and measured significant wave height.

Data from navigation buoys is collected routinely by same system which monitor the buoys location and blinking, once an hour for 5 minutes at the beginning of every hour.

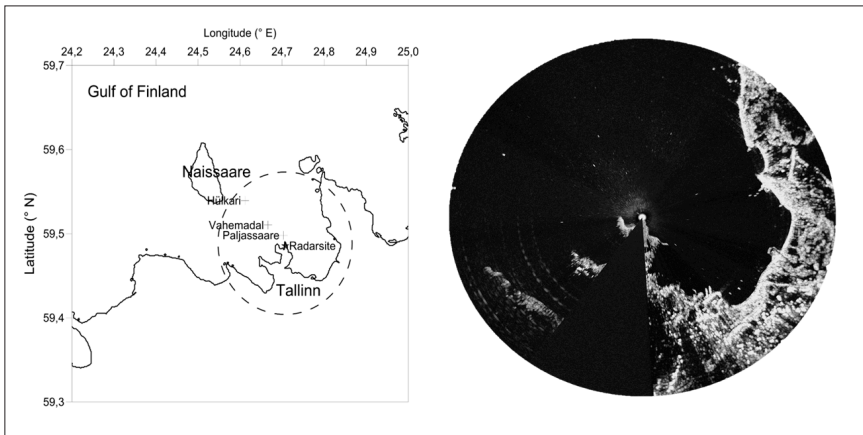

Fig. 1. Map of the Tallinn Bay, locations of radar tower and three buoy stations used for the method development. On the right, an example of radar backscatter.

2.2 Sea state from marine radar data

An empirical function was tuned and developed for significant wave height estimation. The method is based on the analysis of image spectra and was tuned according to collocated *in situ* buoy data. Developed method follows the algorithms used in SAR oceanography where the image processing starts with Fast Fourier Transform (e.g. Pleskachevsky, et al. 2016; Rikka, et al. 2017).

The input for the method is Portable Network Graphics (PNG) file with the resolution of 4096 by 4096 pixels (Fig. 9). The time resolution of the images is the same, as the rotation rate of the antenna 3 seconds and images are rasterized to 5 by 5m pixel resolution with the useable range of calculations being about 10km in radius. Each image is then divided into user defined subsets for image spectrum calculations. Eight consecutive images are used to retrieve significant wave height at the beginning of every full hour. To be specific image spectrum and other parameters are derived separately from eight images and then averaged.

The method was tuned using the collocated *in situ* data from three buoys deployed in the Tallinn Bay. The measurement campaign was carried out from 18 October – 14 November 2016 with stationary measurement location of Vahemadal and two additional buoy stations near the Paljassaare peninsula and Hülkari madal. In total 1678 data points were used. The best fit regression was found between measured wave height and image spectrum parameters to determine the most accurate function to estimate significant wave directly from radar images.

The output of the developed program is radar image with color-coded overlay of significant wave height (Fig. 2 (c)), spectrum image file, calibrated input subset, and text file with all the calculated parameters.

2.3 Analysis of navigation buoy movement to estimate wave height

Data processing by the wave height calculation algorithm is updated so that the results are not influenced by the position of the Z axis when it is not perfectly upright (buoy heeling). Resulting calculations are slightly more resource demanding and therefore not much faster (average 780ms against average 785ms of the previous version) but the intra-modular data exchange is faster and more dependable.

In addition, implementation of the wave height calculation using the method published by the National Oceanic and Atmospheric Administration (NOAA, USA) was tried out but did not produce results comparable to precision of the original algorithm in general, except at low significant wave heights (up to 1.5m). It was developed for wave following buoys and appeared to capture mainly the magnitude of the movement of the buoy itself.

3. Results

3.1 Significant wave height from coastal radar images

The developed algorithm was applied to radar images collected during the January 2017. First step of the method is to read image data (Fig. 2 (a)) from which image spectrum is calculated (Fig. 2 (b)). Image spectrum is used to derive different parameters, e.g. peak location, image energy, etc.

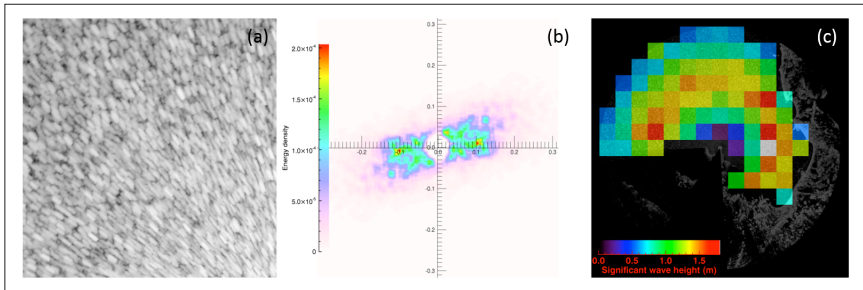

Fig. 2. (a) radar input for the developed method; (b) image spectrum; (c) significant wave height calculated from the radar image with color-coded results.

As can be seen from Fig. 3, the developed method can estimate significant wave height relatively accurately with Pearson correlation coefficient r of 0.79 and the RMSE of 60cm. Although some improvements can be made, for example in radar results there seems to be a “noise floor” around 0.5m which is not considered, wave height estimated from radar images is generally accurate.

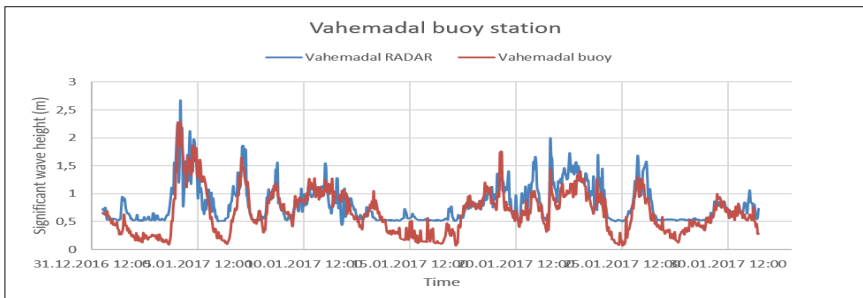

Fig. 3. Comparison between measured wave height in Vahemadal buoy station and corresponding radar values. The Pearson correlation coefficient r is 0.79 with RMSE of 60 cm.

3.2 Significant wave height from navigation buoy movement data

Comparative graphs of wave heights calculated using the initial algorithm (ORIG), initial algorithm with wave height limit applied (MIN_MAX_V1), new improved algorithm (MIN_MAX), and the NOAA algorithm are presented in Fig. 1. During significant heeling periods of certain buoys the original algorithm reported wave heights up to 15m while the new algorithm produces only 2.5m results after processing the same acceleration data set.

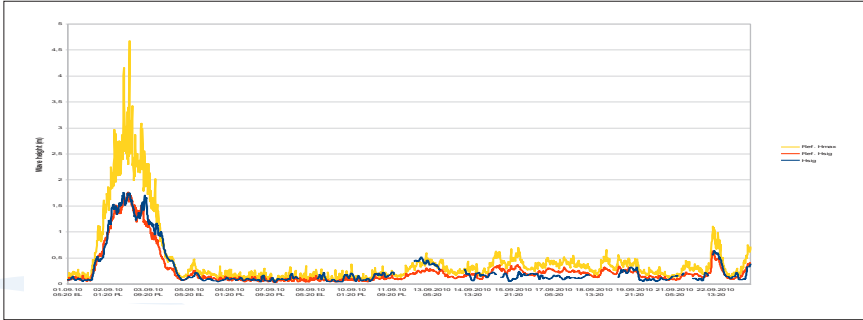

Fig. 4. Comparison of significant wave height calculation results from navigation buoy (blue), as compared with pressure sensor based wave gauge, significant wave height (red) and max wave height (yellow). The navigation buoy carrying the lantern with telematics unit registering and uploading triaxial acceleration data was a 3.5 t steel ice buoy of type SJP3, deployed at 14m depth using a steel mooring.

The difference between the initial algorithm with wave height limitation of 2.5m applied and the new algorithm is shown in Fig. 5.

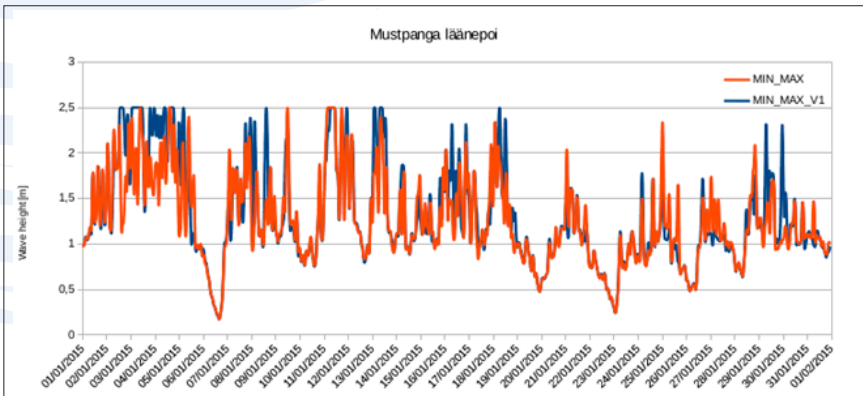

Fig. 5. Comparison of wave height calculation results of the new algorithm (MIN_MAX) with the height-limited old algorithm (MIN_MAX_V1) applied to same input data.

4. Conclusion

An empirical method is developed for X-band marine radars and navigation buoys movement for estimating significant wave height in the Tallinn Bay. The algorithm uses radar backscatter as an input for image spectra calculations which is then used to retrieve wave height. Comparison between measured wave height and estimated wave height from the radar data show high agreement in the case of both high and low sea state. The method is currently developed and deployed in the Bay of Tallinn and the outlook is to build an operational service for the area.

Acknowledgements

The study was supported by institutional research funding IUT (19-6) and Personal Research Funding PUT1378 of the Estonian Ministry of Education.

References

- Pleskachevsky A.L., Rosenthal W. and Lehner S. (2016). Meteo-marine parameters for highly variable environment in coastal regions from satellite radar images. *ISPRS Journal of Photogrammetry and Remote Sensing*, 119, pp.464-484.
- Rikka S., Uiboupin R. and Alari V. (2017). Applicability of SAR-based wave retrieval for wind-wave interaction analysis in the fetch-limited Baltic. *International Journal of Remote Sensing*, 38(3), pp.906-922.
- Soomere T. and Rannat K. (2003). An experimental study of wind waves and ship wakes in Tallinn Bay. In *Proceedings of the Estonian Academy of Sciences: Engineering* (Vol. 9, N° 3, pp. 157-184).
- Soomere T. (2005). Wind wave statistics in Tallinn Bay. *Boreal Env. Res*, 10(2), pp.103-118.
- Soomere T., Elken J., Kask J., Keevallik S., Kõuts T., Metsaveerb J. and Petersonc P. (2003). Fast ferries as a new key forcing factor in Tallinn Bay. In *Proceedings of the Estonian Academy of Sciences, Engineering* (Vol. 9, No. 3, pp. 220-242). Estonian Academy Publishers.
- Reichert K., Hessner K., Nieto Borge J.C. and Dittmer J. (1999). WaMoS II: A radar based wave and current monitoring system. In *The Ninth International Offshore and Polar Engineering Conference*. International Society of Offshore and Polar Engineers.
- Hessner K., Reichert K., Dittmer J. and Borge J.N. (2003). Ocean Wave Measurements by X-Band Radar: from Spectral Wave Parameters to Single Wave Detection, IFREMER Seminar, 2003.
- Dankert H., Horstmann J. and Rosenthal W. (2005). Wind-and wave-field measurements using marine X-band radar-image sequences. *IEEE Journal of oceanic engineering*, 30(3), pp.534-542.

A LONG-TERM STRATEGY FOR MONITORING THE SALT WATER INFLOWS IN THE SOUTHERN BALTIC SEA

W. Walczowski⁽¹⁾, P. Wieczorek, I. Goszczko, M. Merchel, D. Rak, A. Beszczynska-Möller and M. Cisek

⁽¹⁾ Institute of Oceanology Polish Academy of Sciences, 81-712 Sopot, Powstancow Warszawy 55, walczows@iopan.pl

Abstract

We present a long-term strategy for observations of the salt waters inflows in the southern Baltic Sea, developed and under implementation by the Institute of Oceanology of the Polish Academy of Sciences. To monitor properties and dynamics of the deep inflows different data sources will be employed, including hydrographic sections from synoptic surveys, Eulerian data from a moored buoy and Lagrangian data provided by Argo floats. All data will be integrated under the framework of the SatBaltic system. A part of the planned infrastructure has been already implemented and delivers the data while other elements will be ready for deployment at the end of 2017.

Keywords: Baltic Sea, Argo floats, salt water inflows

1. Introduction

Deep inflows of highly saline and oxygen-rich waters, originating from the North Sea are vital for the Baltic Sea ecosystem (Neumann *et al.*, 2017). After passing through the Danish Straits, the inflow waters follow the route along the Arkona Basin, Bornholm Gate, Bornholm Deep, Slupsk Channel and Gdansk Deep (Bulczak *et al.*, 2016). The frequency and intensity of inflows vary in time and after the long period of stagnation, the inflows occur more often in recent years (Mohrholtz, 2015). Monitoring of the inflows, focused on their dynamics and related fluxes of salt and oxygen, is of a highest importance for recognizing the current status of the Baltic Sea ecosystem and predicting its future. Among others, the fish stock, especially Baltic cod, depends heavily on renewal of the deep waters, resulting from the saline inflows.

2. Observations

The Institute of Oceanology Polish Academy of Sciences (IOPAN) has investigated the key regions of the Baltic proper since the late 80s. Every year 3-4 cruises of the IOPAN research vessel Oceania take place to monitor the deep water dynamics and inflow processes. The standard high-resolution CTDO hydrographic section follows the main inflow route (Fig. 1a). In the last three decades a few major inflows and numerous small events were observed (Fig. 1b) during the repeated surveys (Piechura and Beszczynska-Möller, 2004; Rak., 2016).

However, the long-term integrated observing strategy to cover different spatial and temporal scales is still lacking. To improve data coverage and establish the sustained observations, the additional observational methods have to be employed in future to complement the standard synoptic surveys.

The Argo float system has been originally developed for observations in deep oceans. At present almost 4000 floats collect measurements in the global ocean and a significant part of these floats is deployed under the Euro-Argo program. The next phase of the Euro-Argo includes the extension of the float system into the polar oceans and the marginal seas (Euro-Argo, 2017).

IOPAN contributes to both efforts as a leader of the Argo-Poland project (<http://www.iopan.gda.pl/hydrodynamics/po/Argo/argo.html>). For the last decade IOPAN has deployed floats in the Nordic Seas and in 2016 we started deployments of Argo floats in the southern Baltic. The Argo APEX float deployed in March 2017 collected profiles in the entire Bornholm Basin region (Fig. 2a). Newly obtained data allow studying the spatial and seasonal variability of water properties and circulation in the southern Baltic Sea (Fig. 2b).

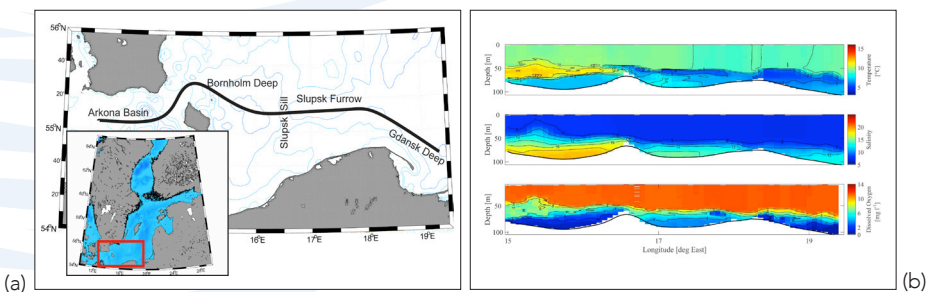

Fig. 1. (a) The main hydrographic section through the deep basins of the Baltic Proper and (b) distribution of temperature, salinity and dissolved oxygen along the section during the small inflow in November 2015.

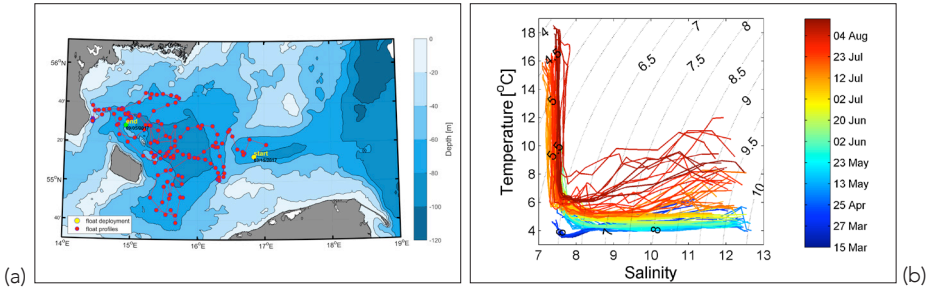

Fig. 2. (a) Trajectory of the Argo float in the Southern Baltic from 15.03.2017 to 5.09.2017 and (b) T-S diagram of the Argo float data.

In September 2017 two ARVOR floats, delivered by Euro-Argo ERIC in the frame of collaboration with MOCCA project, were deployed in the Southern Baltic.

To complement measurements with Argo floats, the NRT continuous measurements will be collected by a moored surface buoy, integrated in the SatBaltic system (Wozniak, 2011) and available online (<http://www.satbaltyk.pl/en/>). The refurbished and modernized Oceanor buoy (Fig. 3a) will be deployed in the Slupsk Channel, east of the Slupsk Sill, in the autumn 2017. Standard meteorological measurements, hydrographic data from the surface and bottom layers (Fig. 3b) as well as sea current profiles provided by ADCP and covering the whole water column will be transmitted via a satellite connection.

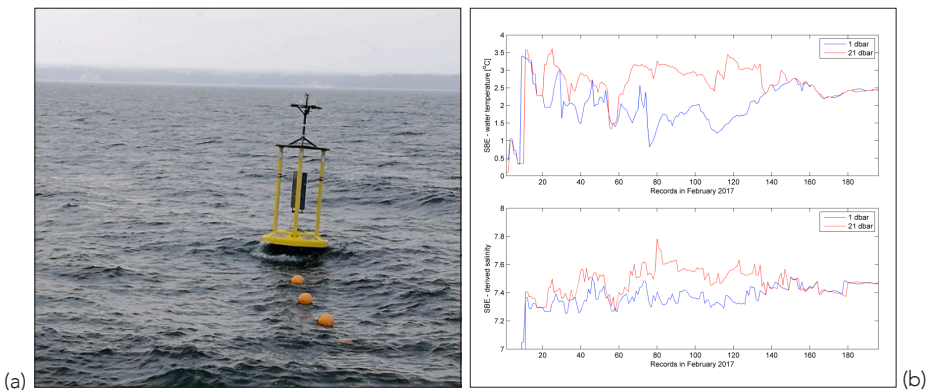

Fig 3. (a) Tests of the Oceanor buoy in the Gdansk Bay and (b) test time series of temperature and salinity in the upper and bottom layer.

3. Conclusion

Rapid changes in the marine environment require constant monitoring and near real time access to data. Autonomous measurement systems are becoming more and more important. Therefore three different measurement systems, including repeated seasonal hydrographic surveys, Lagrangian measurements by Argo floats and Eulerian measurements by instrumentation on the moored buoy, will provide an extensive, complementary data set for monitoring of the inflows properties and dynamics. Data will be distributed to international data centers and available in the IOPAN database. Collected data will be employed for improvement of numerical models and validation of satellite observations carried under the SatBaltic system and results of the integrated analysis will be openly available on the system platform.

Acknowledgements

Authors acknowledge the grant Argo-Poland DIR/WK/2016/12 of Polish Ministry of Science and Higher Education.

References

- Bulczak A.I., Rak D., Schmidt B., Beldowsk J., (2016), Observations of near-bottom currents in Bornholm Basin, Slupsk Furrow and Gdansk Deep, Deep-Sea Research Part II: Topical Studies in Oceanography, 128, pp. 96-113, DOI: 10.1016/j.dsr2.2015.02.021.
- Euro-Argo ERIC members, (2017), Strategy for evolution of Argo in Europe, <http://archimer.ifremer.fr/doc/00374/48526/>
- V. Mohrholz, M. Naumann, G. Nausch, S. Krüger, U. Gräwe, (2015), Fresh oxygen for the Baltic Sea – an exceptional saline inflow after a decade of stagnation J. Mar. Syst., 148 (2015), pp. 152-166, 10.1016/j.jmarsys.2015.03.005.
- Neumann, T., H. Radtke, and T. Seifert, (2017), On the importance of Major Baltic Inflows for oxygenation of the central Baltic Sea, J. Geophys. Res. Oceans, 122, doi:10.1002/2016JC012525.
- Piechura J., Beszczynska-Moeller A., 2004, Inflow waters in the deep regions of the southern Baltic Sea – transport and transformations, *Oceanologia*, 46-1, 2004.
- Rak D., (2016). The inflow in the Baltic Proper as recorded in January — February 2015. *Oceanologia* 58 (3), 241—247, <http://dx.doi.org/10.1016/j.oceano.2016.04.001>.
- Wozniak B., et al., (2011), SatBałtyk – A Baltic environmental satellite remote sensing system – an ongoing project in Poland. *Oceanologia*, 53(4).

OPERATIONAL IN SITU OIL SPILL DETECTION IN THE BALTIC SEA, USING FERRYBOX SYSTEM EQUIPPED WITH OIL SENSOR

T. Kõuts, S. Pärt and K. Vahter

Marine Systems Institute, Tallinn University of Technology, Akadeemia str 15a, Tallinn 12618, Estonia, tarmo.kouts@ttu.ee

Abstract

Intensive maritime traffic in the Baltic Sea increases oil spill probability. Spatial distribution of detected oil spills show that they are most probably noted on major ship routes, which leads to idea to monitor oil in water with Ships Of Opportunity (SOOPs). UV (Ultra-violet) fluorescence is highly sensitive and straightforward method to determine oil-based aromatic compounds in seawater, sensitivity up to 0.001 µg/L. FerryBox system developed by TUT Marine Systems Institute is used on board ferry M/S BALTIC QUEEN, during GRACE project, UviLux UV-fluorometer (Chelsey Instruments Ltd) is used to monitor oil compounds, polycyclic aromatic hydrocarbons (PAHs) in surface layer of the open sea in parallel with seawater temperature, salinity and turbidity. Such a system with real time data transfer enables asset for automated detection and monitoring of oil spills on Tallinn – Stockholm fairway.

Results of the study show reliable operation of the FerryBox system equipped with UviLux oil sensor and PAH concentrations (in terms of Carbazole) varying between 0,12-0,74 µg/ with stable variability pattern along the fairway. No actual oil spills were recorded during measurement period. In situ oil detection allows to monitor small spills, which are mostly undetected by remote sensing methods and repeated tracks give data for statistical analysis.

Keywords: FerryBox, SOOP, Real-time data, Baltic Sea, Surface water monitoring, Oil-spill detection, PAH, UV-fluorometer

1. Introduction

The Baltic Sea, with its high maritime traffic, has increased probability for oil pollution occurrence. Spatial distribution of detected oil spills show that they are most probably noted on major ship routes, which has led to the idea to detect and monitor oil in water with FerryBox system on board a ferry between Tallinn and Stockholm. FerryBox systems for automated measurements utilizing ships of opportunity have reached reliability status (Petersen 2014). The installed systems can integrate data from water quality and meteorological sensors with GPS information into a data stream that is automatically transferred from ship to shore. In general, all FerryBox systems employ a similar design - the system consists of a water inlet from where the water is pumped into the measuring circuit containing multiple sensors and gathered data is transmitted to shore via GSM/GPRS connection or satellite communication in real time.

2. Methods

The compact FerryBox system developed by Marine Systems Institute at Tallinn University of Technology is used on board of the M/S BALTIC QUEEN (Tallink Group). For detecting and monitoring oil in surface layer of the sea an UviLux (Chelsey Instruments Ltd) UV-fluorometer is used. Other seawater properties are recorded by the same system in parallel – temperature, salinity and turbidity. UV (Ultra-violet) fluorescence is considered to be highly sensitive, reasonably selective, simple, rapid and straightforward method to determine oil-based aromatic compounds in seawater, even in low concentrations. Sensitivity of the UviLux sensor is up to 0.005 µg/L. Sensors calibrated range is 0,005 – 2000 µg/L of oil compounds polycyclic aromatic hydrocarbons (PAH) concentration (in terms of Carbazole), excitation light 255nm and emission light 360nm.

Water for analysing is taken from the ferry's sea chest. Parameters are measured in one minute intervals, giving a 100-150m spatial resolution along the fairway, where occurrence of oil spills is most probable.

Data from the sensors in FerryBox is collected by datalogger and transferred in real time into on shore FTP server of the Marine Systems Institute, using GSM/GPRS protocol with one minute interval. GPS data and time stamps are added to the FerryBox measurement data.

Special web-based user interface is built to visualize data on-line <http://on-line.msi.ttu.ee/GRACEferry> where FerryBox data, ship's track, current position and gathered data can be seen both in real-time and with historical views. The web based user interface is equipped with different options: the user can make selection of parameters, time periods, construct map view and 2D graphs of single and multiple parameters. Data is available in tabulated form and can be assessed regarding the quality.

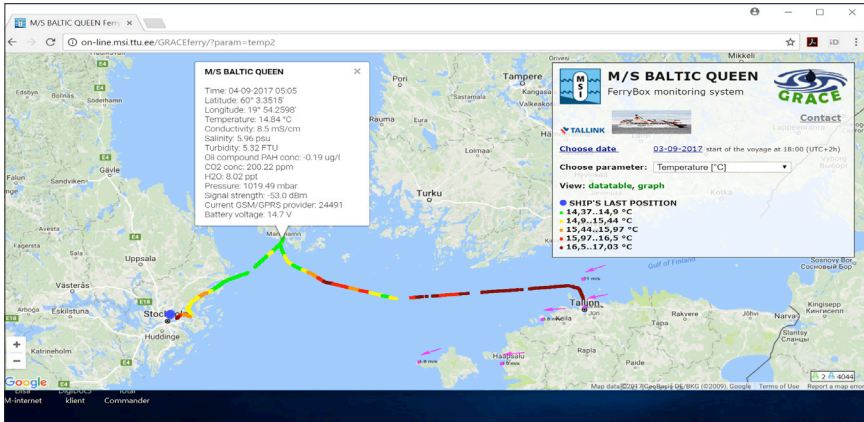

Fig. 1. Screen view of the FerryBox system user interface <http://on-line.msi.ttu.ee/GRACEferry>.

3. Results and Discussion

All together 55 ship voyages were analyzed (16.02 – 11.04.2017), consisting of 960 data points each, 52 800 in all. PAH concentrations varied between 0,12 - 0,36 $\mu\text{g/l}$, having remarkable and quite stable variability patterns, as is with other measured parameters. Measured PAH concentrations are not absolute values, but rather relative, variability patterns can be still estimated.

Sudden concentration rises which would directly indicate oil spills, have not been detected during the observation period, all PAH concentrations have stayed far below those defining an oil spill.

Regular maintenance of the FerryBox system was required during the measurement period, as the optical UviLux sensor was sensitive to biofouling which has an impact on the data quality.

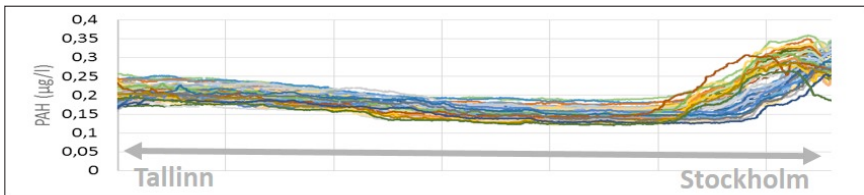

Fig. 2. PAH concentrations (in terms of Carbazole) during 55 ship voyages between Tallinn and Stockholm.

4. Conclusions

FerryBox system equipped with the UV-fluorometer, showed its potential as an oil-spill detection and monitoring tool. Repeated tracks of the ferry allow obtaining statistics of oil compounds in water in different sea areas over longer time period allowing to give estimates for variability pattern of parameters and react in case of anomalies. Especially important is the monitoring of small spills, which stay undetected with conventional remote sensing methods, but are most numerous and detectable only with *in situ* measurements. One drawback of the FerryBox-based oil detection system is the high sensitivity to biofouling, which could be handled with an automated cleaning system.

Acknowledgements

The study has received funding from the European Union's Horizon 2020 research and innovation programme under grant agreement N° 679266 project GRACE (InteGrated oil spill Response ACtions and Environmental effects) focusing on comparing and evaluating the effectiveness and effects of different oil spill response methods in a cold climate.

References

Petersen W. (2014). FerryBox systems: State-of-the-art in Europe and future development. *Journal of Marine Systems*, 140, 4-12.

MULTISCALE AND MULTI-DISCIPLINARY MARINE RAPID ENVIRONMENTAL ASSESSMENT DATA COLLECTION METHODOLOGY FOR OPERATIONAL AND FORECASTING OCEANOGRAPHY

I. Federico⁽¹⁾, F. Maicu⁽²⁾, N. Pinarji^(1,3), P. Oddo⁽⁴⁾, M. Zavatarelli⁽³⁾, V. Lyubartsev⁽¹⁾, S. Causio⁽¹⁾, C. Caporale⁽⁵⁾, M. Demarte⁽⁵⁾, A. Falconieri⁽⁶⁾, R. Lecci⁽¹⁾, T. Lacava⁽⁶⁾, M. Lisi⁽³⁾, A. Sepp-Neves⁽³⁾, G. Lorenzetti⁽²⁾, G. Manfe' ⁽²⁾, F. Trotta⁽³⁾, L. Zaggia⁽²⁾, S. A. Ciliberti⁽¹⁾, C. Fratianni⁽⁷⁾ and A. Grandi⁽⁷⁾

⁽¹⁾ Centro Euro-Mediterraneo sui Cambiamenti Climatici (CMCC), Lecce, Italy

⁽²⁾ Istituto di Scienze Marine, CNR, Venezia, Italy

⁽³⁾ Department of Physics and Astronomy, University of Bologna, Bologna, Italy

⁽⁴⁾ Centre for Maritime Research and Experimentation (CMRE), La Spezia, Italy

⁽⁵⁾ Istituto Idrografico della Marina Militare Italiana, Genova, Italy

⁽⁶⁾ Istituto di Metodologie per l'Analisi Ambientale, CNR, Potenza, Italy

⁽⁷⁾ Istituto Nazionale di Geofisica e Vulcanologia (INGV), Bologna, Italy

Abstract

The work provides an overview on Marine Rapid Environmental Assessment (MREA) experimental and observational methodology developed in the last years, thanks to the synergies between several oceanographic research centers and the Italian Navy Hydrographic Institute.

The approach is based on an optimal strategy (i) to collect evidences on ocean mesoscales and submesoscales with a spatial-and-time synoptic coverage and repeated surveys, (ii) to increase the skills of ocean forecasting, producing both initialization and verification datasets for numerical models.

1. Introduction

The Marine Rapid Environmental Assessment (MREA) is an optimal experimental strategy to collect marine data useful to improve our knowledge of the marine state and specific dynamical processes and increase skill of ocean forecasting and analyses. Data collection and analysis has been developed considering synoptic time scales and repeated surveys to produce both initialization and verification data sets.

The MREA has been implemented globally, in several regions, and adaptive sampling has also been developed (Lermusiaux, 2007, Frolov *et al.*, 2014). Starting from the experiences of the so-called REA (Rapid Environmental Assessment) implementations in Mediterranean areas in late 1990s (Robinson and Sellschopp, 2002, REA96, REA97, REA98 in Fig. 1) developed to collect synoptic oceanographic data relevant for nowcasts, forecasts and derived applications, the Italian MREA experiments (MREA07, MREA08 MREA14, MREA16, MREA17 in Fig. 1), have been progressively improved and adapted to the physical processes to be investigated.

The Italian MREA strategies were thought to contribute to: (i) the definitive set up of a rapid CTD and ADCP collection strategy in different regions of Italy and other areas of particular strategic interest; (ii) the study of surface and near surface processes that couple waves and currents, physical and biochemical processes, from the coastal to the open ocean; (iii) demonstrate and validate the numerical model downscaling from large scale operational and forecasting oceanography products. In the following section we provide a brief overview on the surveys carried out in Taranto Gulf (2014 and 2016) and Ligurian Sea (2017).

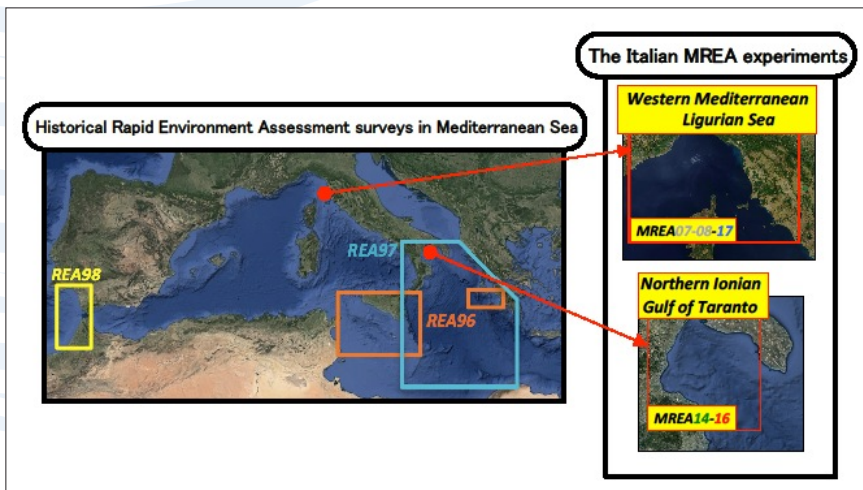

Fig. 1. Sketch of the historical REA surveys in Mediterranean Sea and the Italian MREA in Gulf of Taranto and Ligurian Sea.

2. Methodology, sampling strategies and main results

2.1 MREA14 in Taranto Gulf (Eastern Mediterranean)

The first MREA application was carried out in Taranto Gulf (Eastern Mediterranean) in October 2014 (MREA14, Pinardi *et al.*, 2016) and it was based on the classical regular grid CTD sampling strategy at different oceanographic scales (from large- to shelf- to coastal-scale), with the repetition of stations on a weekly basis.

The large-scale surveys (LS1 and LS2 in Fig. 2a) were carried out with a quasi-synoptic timescale, in Taranto Gulf area, which is on average 800m deep. The stations were repeated in order to understand large-scale temperature and salinity changes on a weekly basis. The mean station distance between stations was 16 km, which is about the Rossby radius of deformation for the eastern Mediterranean (Hecht *et al.*, 1988). This spacing was chosen as a good compromise between the horizontal resolution and the time needed to cover the area synoptically.

The shelf-scale (CS1 in Fig. 2a) survey was carried out in the northeastern Gulf of Taranto, an extended shelf area of the Gulf. The mean distance between the stations was 5km and the mean depth of the area was 400 m. The coastal harbor survey (MG1 in Fig. 2a) covers the shelf area of the Mar Grande, which is a heavily human impacted harbor area. The distance between stations in the Mar Grande is ~1km and the mean depth was 15m.

The analysis of the water masses properties and circulation fields highlighted the presence of a submesoscale eddy, also reproduced in numerical modeling investigation based on multiple nesting (Trotta *et al.*, 2017, companion presentation in EUROGOOS2017). Furthermore, the observed data have been adopted to assess performances of operational forecasting systems (Federico *et al.*, 2017) and downscaling approach from sub-regional to coastal and harbor scale (Gaeta *et al.*, 2016).

2.2 MREA16 in Taranto Gulf (Eastern Mediterranean)

The second experiment (MREA16) was carried out in 2016 again in Taranto Gulf, but in a different season (Summer).

Since the main objective was to evaluate the possible changes of the large-scale circulation compared with the previous MREA, the MREA16 focused on LS1 and LS2 surveys (Fig. 2b). Additional measurements one-day long were performed in fixed stations (CG1 and CG2, in Fig. 2b) in coastal waters to assess daily cycle of temperature. Furthermore, the sampling methodology tested in 2014 was refined and strengthened by integrating the classical CTD data collection with additional simultaneous measurements of currents by means of vessel-mounted ADCP. The strategy was completed by sampling of optical properties of sea surface with radiometric surface measurements. The set-up of measurements during the on-board operations is reported in bottom panel of Fig. 2b.

The comparison with MREA2014 shows the reverse of circulation from the large-scale gyre anticyclonically-oriented in Autumn (MREA14) and cyclonically-oriented in Summer (MREA16).

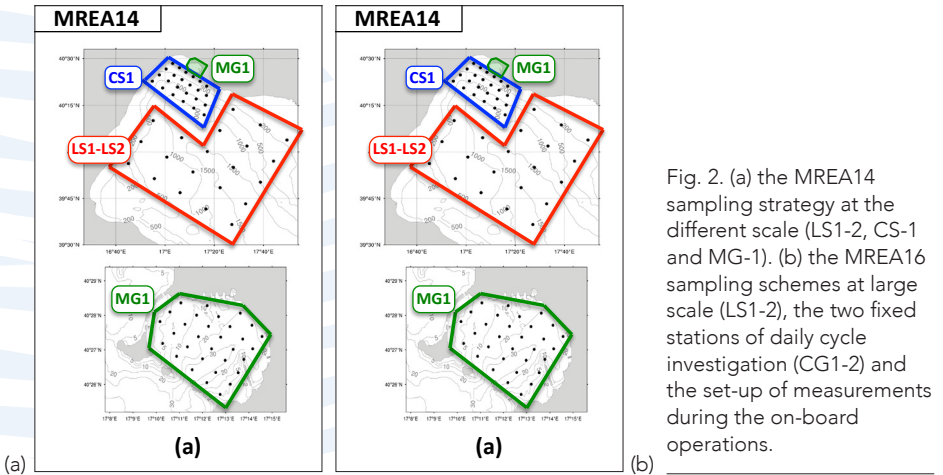

Fig. 2. (a) the MREA14 sampling strategy at the different scale (LS1-2, CS-1 and MG-1). (b) the MREA16 sampling schemes at large scale (LS1-2), the two fixed stations of daily cycle investigation (CG1-2) and the set-up of measurements during the on-board operations.

2.3 MREA17 in Ligurian Sea (Western Mediterranean)

The next campaign (MREA17) planned in Autumn 2017 in Ligurian Sea (Western Mediterranean) will adopt a new approach, consisting in the use of sampling schemes with increasing spatial resolution covered simultaneously by two ships. This will allow to capture possible submesoscale structures and simultaneously characterize the large scale dynamics. The spacing between stations range from the 2.5km (SM-2500 survey in Fig. 3a) to 500m and 250m (SM-500, SM-250 and SM-hyb in Fig. 3a).

The multiscale-multidisciplinary aspects are addressed combining standard shipborne instrumentations already tested in MREA16 (classical CTD and vessel-mounted ADCP) with underwater remotely operated towed vehicles equipped with multidisciplinary sensors. The set-up of measurements during the on-board operations in the two ships is reported in bottom panel of Fig. 3b.

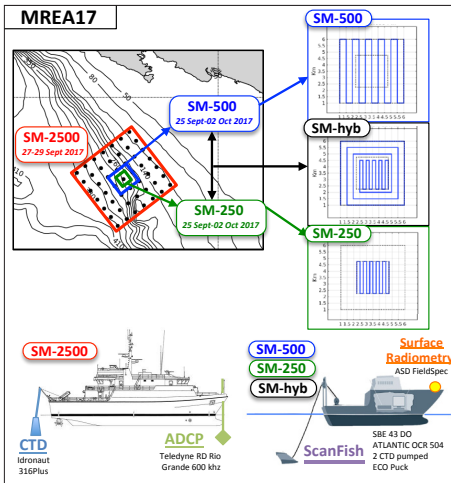

Fig. 3. The MREA17 sampling strategy at the different sub-meso-scale (SM-2500, SM-500, SM-200 and SM-hyb), and the set-up of measurements during the on-board operations.

3. Conclusions

The MREA methodology has been developed, progressively improved and refined with standard protocols for the on-board operations. The sampling methodology has been strengthened in the last years integrating (i) the classical CTD data collection with additional simultaneous measurements of (ii) currents by means of vessel-mounted ADCP, (iii) optical properties of sea surface with radiometric surface measurements and (iv) underwater remotely operated towed vehicles, equipped with CTD, oxygen and light sensors. The methodology has been verified to be relocatable in different areas (Ligurian Sea and Gulf of Taranto), at multiple scales (from large- to meso- to submeso- scale).

The MREA data collections have allowed (i) supporting operational and forecasting oceanography (producing both initialization and validation datasets and increasing the forecasting skills), and (ii) performing process study (e.g. the possible formations of sub-mesoscale structures, the reversal of circulation in certain periods of the year from anticyclonic to cyclonic in Gulf of Taranto).

Further information and data download is available at the following link: <http://mrea.sincem.unibo.it/>.

References

- Federico I., Pinardi N., Coppini G., Oddo P., Lecci R. and Mossa M. (2017). Coastal ocean forecasting with an unstructured grid model in the southern Adriatic and northern Ionian seas, *Nat. Hazards Earth Syst. Sci.*, 17, 45-59.
- Frolov S., Garau B. and Bellingham J. (2014). Can we do better than the grid survey: Optimal synoptic surveys in presence of variable uncertainty and decorrelation scales, *J. Geophys. Res.-Oceans*, 119, 5071–5090.
- Gaeta M.G., Samaras A.G., Federico I., Archetti R., Maicu F. and Lorenzetti G. (2016). A coupled wave–3-D hydrodynamics model of the Taranto Sea (Italy): a multiple-nesting approach, *Nat. Hazards Earth Syst. Sci.*, 16, 2071-2083.
- Hecht A., Pinardi N. and Robinson A. R. (1998). Currents, Water Masses, Eddies and Jets in the Mediterranean Levantine Basin, *J. Phys. Oceanogr.*, 18, 1320–1353.
- Lermusiaux P. F. J. (2007). Adaptive modeling, adaptive data assimilation and adaptive sampling, *Physica D*, 230, 172–196.
- Pinardi N., Lyubartsev V., Cardellicchio N., Caporale C., Ciliberti S., Coppini G., De Pascalis F., DIALTI L., Federico I., Filippone M., Grandi A., Guideri M., Lecci R., Lamberti L., Lorenzetti G., Lusiani P., Macripo C.D., Maicu F., Mossa M., Tartarini D., Trotta F., Umgiesser G. and Zaggia L. (2016). Marine Rapid Environmental Assessment in the Gulf of Taranto: a multiscale approach, *Nat. Hazards Earth Syst. Sci.*, 16, 2623-2639
- Robinson A.R. and Sellschopp J. (2002). Rapid Assessment of the Coastal Ocean Environment. *Ocean Forecasting: Conceptual Basis and Applications*. N. Pinardi & J.D. Woods, Springer, 203-232.
- Trotta F., Pinardi N., Fenu E., Grandi A. and Lyubartsev (2017). Multi-nest high resolution model of submesoscale circulation features in the Gulf of Taranto, *Ocean Dynamic*, 67, 12, 1609–1625.

OPERATIVE MET-OCEAN MEASUREMENTS - CHALLENGES AND OPTIONS

D. Klarić⁽¹⁾ and D. Rašić⁽²⁾

⁽¹⁾ Meteorological and Hydrological Service of Croatia, Marine Meteo Center.
dijana.klaric@cirus.dhz.hr

⁽²⁾ Meteorological and Hydrological Service of Croatia, Marine Meteo Center

Abstract

Meteorological and Hydrological service of Croatia (abb. DHMZ) is running operative met-ocean monitoring of the sea state by observations and measurements. Recently DHMZ started with the update of the sea state and sea physical measurements in the three directions: new design for real-time network of met-ocean moored buoys measurements; new real time sea surface temperature buoys network for sea climatology; real time Voluntary observing ships (VOS) automatic weather stations from E-SURFMAR actions. Innovative IT options with data transfer via radio dissemination has been explored - Application Specific Messages (AMS) for Automatic Identification System (AIS).

Keywords: moored-buoys, VOS, AtoN AIS

1. Introduction

Meteorological and Hydrological service of Croatia has been state authority for meteorological and marine meteorological analyses, forecasts and warnings for more than 70 years. The operative met-ocean monitoring of the sea state has been provided by observations and measurements. The real-time monitoring at 3h frequencies at marine stations and marine traffic lighthouses has been the main origin of real-time data for the decades (see Fig. 1). System is obsolete in the terms of data quantity and quality, taking into account requirements for feeding National Adriatic Sea monitoring and forecasting system, that is under the development.

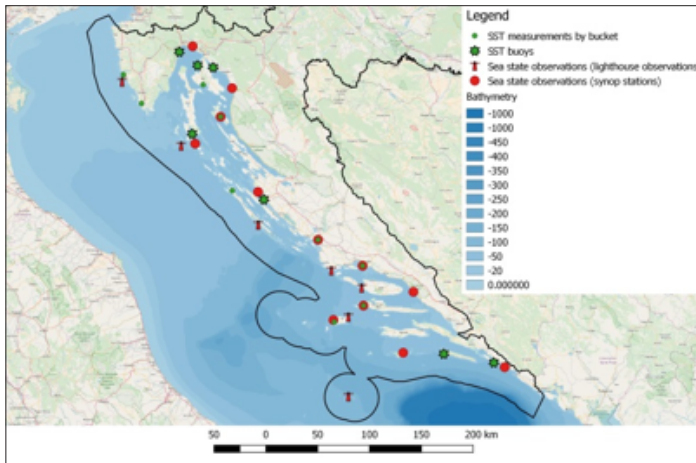

Fig. 1. Sea observation network, status Jan 2017: sea surface temperatures measured by buoys and buckets; sea-state observed at synop-stations and lighthouses.

2. Modernisation of network - Metmonic

According to the review and recommendations of Oklahoma University, Met service of Croatia started the program METMONIC – Modernization of meteorological network at Croatia, with new design for real-time network of met-ocean moored buoys measurements for the purpose of nowcasting and forecasting as well. The network of met-ocean moored buoys is designed to cover the territorial waters of Croatia, at open waters and at the area of open sea-inner waters circulation, for the purpose of sea oceanography and chemistry at the water depth down to 200m. The network will measure also the wind waves and meteorological parameters (5 moored buoys as the start). A new real time sea surface temperature buoys network for sea climatology is also planned.

2.1 AIS ATON Solutions

The safety and efficiency of the marine traffic has been in the focus of national and regional maritime authorities coordination. To contribute with METMONIC products, innovative IT options with data transfer via radio dissemination has been explored - Application Specific Messages (AMS) for Automatic Identification System (AIS).

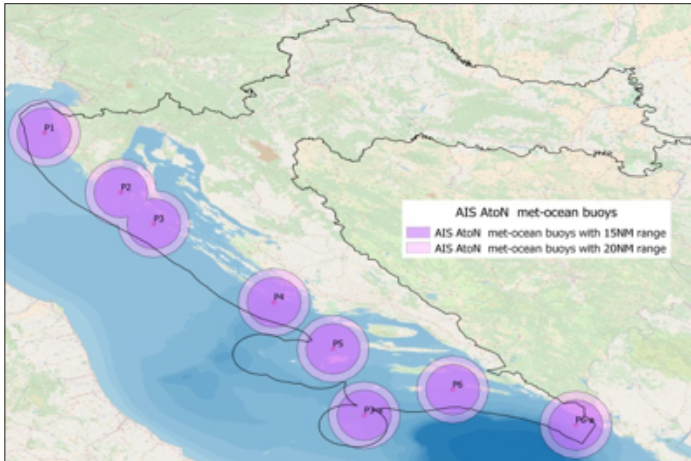

Fig. 2. Positions for future met-ocean moored-buoys with the active AIS AtoN radio dissemination system in the range 15-20 NM.

3. E-SURFMAR voluntary observing ships program implementation

DHMZ as the member of European network of meteorological services – EUMETNET is part of the program E-SURFMAR, that provides meteorological and sea state measurements and monitoring coordinated by met services. E-SURFMAR Voluntary Observing Ships (VOS) fleet has been operating for many years, where DHMZ is contributing with 1 VOS ship. In order to improve the timeliness of VOS data exchange as well to provide the efficient and affordable satellite dissemination of data, E-SURFMAR started project EUCAWS EU Common Automatic Weather Station, that plan to modernize E-SURFMAR VOS fleet with standard data quality and formats, distributed via IRIDIUM system to Meteo-France WIS DCPC center. DHMZ is under installation of 1EUCAWS ship in 2017, and have plan to equip 3 ships more within next 2 years.

The system will be designed to fit into the WIGOS marine national system of data integration and distribution, as part of the National Adriatic Sea monitoring and forecasting system.

References

Cohuet J.B et al (2016). The Shipborne European Common Automatic Weather Station. *WMO 125-TECO-2016*, 16pp.

IALA (2002): Guidelines on the Universal Automatic Identification System (AIS), *IALA*,134pp.

Oklahoma University (2009): DHMZ Modernization Project. Oklahoma. 390 pp.

WMO (2017): Manual on the WMO Integrated Global Observing System (WIGOS). *WMO- N°. 1160*, 97pp.



A NEW AERONET-OC SITE FOR THE NORTHERN NORTH SEA

R.M. Forster⁽¹⁾, V. Créach⁽²⁾ and C. Soraghan⁽³⁾

⁽¹⁾ University of Hull, United Kingdom

⁽²⁾ Centre for Aquaculture, Fisheries and Environmental Sciences

⁽³⁾ Offshore Renewable Energy Catapult

1. Introduction

The need for high-frequency, high-quality optical measurements at sea level to support and validate satellite measurements of ocean colour has long been recognised (Zibordi, Berthon, *et al.* 2009). With the aims of creating new satellite products for Sentinels 2 and 3, and greatly increasing the availability of marine *in situ* data for validation, the HIGHROC proposal was submitted to Framework 7, and subsequently received funding for four years. A large dataset of *in situ* measurements of coastal water quality has been generated in the project. Automated SMARTBUOY and FERRYBOX systems were used to produce a database of high quality measurements (suspended sediment load, chlorophyll concentration and underwater light penetration). These are the types of data which are typically used in national assessments of water quality, and in Environmental Statements by maritime industry. Utilisation of automated *in situ* measurements can greatly increase the number of match-ups with satellite data (Neukermans *et al.* 2012).

In addition to the in-water measurements, readings of the radiance leaving the water surface are very important for satellite validation (Zibordi, Mélin, *et al.* 2009, Zibordi *et al.* 2015). The water-leaving radiance (L_w) is equivalent to the radiance measured by a satellite after correction for attenuation of light in the atmosphere. There are at present no suitable operational measurements of L_w in UK waters, indeed there were none in the whole of the North Sea prior to HIGHROC. To improve the coverage of sea-level radiance in the North Sea, three new AERONET_OC sites have been established (Fig. 1).

Cefas and the University of Hull are working together with the Offshore Renewable Energy Catapult centre in the development of an AERONET ocean-colour measuring station located at an experimental meteorological tower in the northern North Sea.

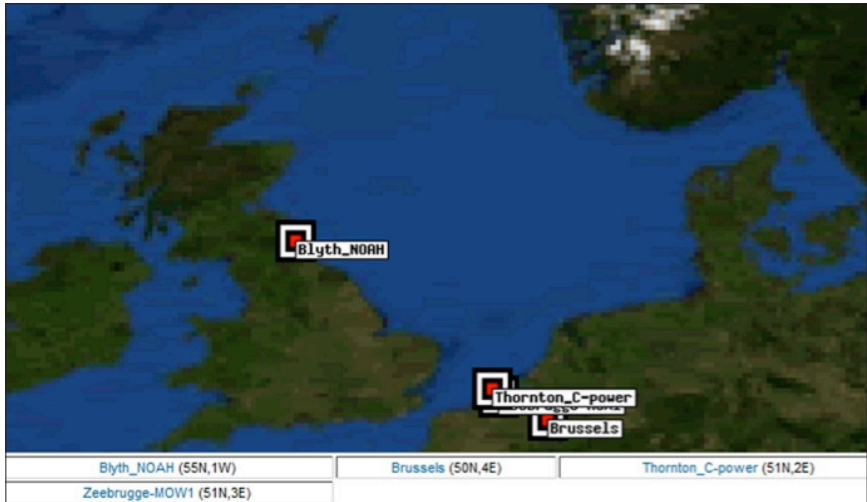

Fig. 1. Location of the three new AERONET_OC sites in the North Sea.

2. Methods

The NOAH tower is located in 35m of water off the coast of Northumberland at 55.15° N: 1.42° W near an experimental offshore windfarm (Blyth Offshore Demonstrator project, Fig. 3). The radiometric sensor is held above the sea surface at an elevation of 19.0m (Fig. 2). Power is supplied by a wind/PV primary power unit with a diesel Genset backup. Dedicated microwave links and CCTV observations support communications and viewing of the instrument performance.



Fig. 2. South-facing location of the AERONET_OC SeaPrism radiometer.

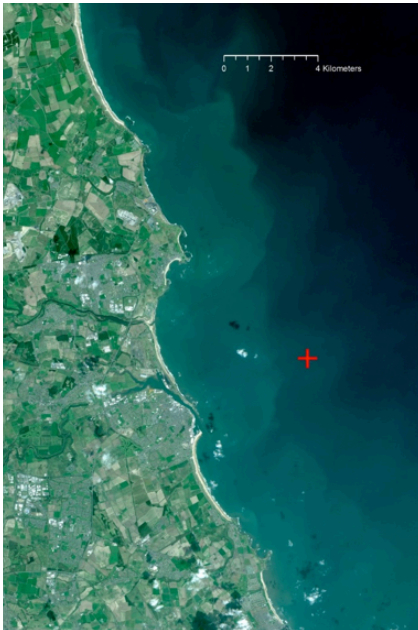

Fig. 3. Location of the NOAH platform.

3. Results and conclusions

Optical conditions at the site range from low chlorophyll, clear case-1 type in summer, through to sediment and cDOM dominated water types during winter, particularly when river plumes are present. Measurements of L_w from the NOAH site will allow therefore a detailed comparison to be made between atmospherically-corrected satellite estimations of radiances in the spectral bands of Sentinel 2 and 3 scenes across a wide range of optical situations (Fig. 4).

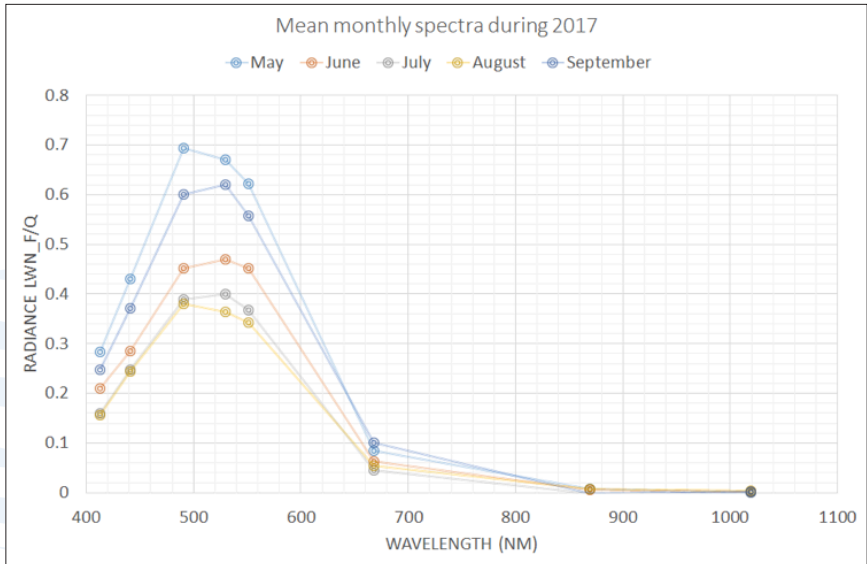

Fig. 4. Monthly mean water-leaving radiance at the Blyth AERONET_OC site.

Data are available from the AERONET_OC website at http://aeronet.gsfc.nasa.gov/new_web/ocean_color.html.

Acknowledgements

The installation was funded by HIGHROC (FP7-space, 606797).

References

- Neukermans G., Ruddick KG., Greenwood N., (2012) Diurnal variability of turbidity and light attenuation in the southern North Sea from the SEVIRI geostationary sensor. *Remote Sens Environ* 124:564–580
- Zibordi G., Berthon JF, Mélin F, D’Alimonte D., Kaitala S. (2009) Validation of satellite ocean color primary products at optically complex coastal sites: Northern Adriatic Sea, Northern Baltic Proper and Gulf of Finland. *Remote Sens Environ* 113:2574–2591
- Zibordi G., Mélin F, Berthon J-F, Holben B., Slutsker I., Giles D., D’Alimonte D., Vandemark D., Feng H., Schuster G., Fabbri BE., Kaitala S., Seppälä J., (2009) AERONET-OC: A Network for the Validation of Ocean Color Primary Products. *J Atmos Ocean Technol* 26:1634–1651
- Zibordi G., Mélin F, Berthon J-F, Talone M. (2015) In situ autonomous optical radiometry measurements for satellite ocean color validation in the Western Black Sea. *Ocean Sci* 11:275–2

A NEW DATABASE OF QUALITY-CONTROLLED PHYTOPLANKTON PIGMENTS FOR THE EUROPEAN NORTH-WEST SHELF

K. Collingridge⁽¹⁾, R. Forster⁽²⁾, E. Capuzzo⁽¹⁾, L. Schlüter⁽³⁾, T. Hull⁽¹⁾ and V. Creach⁽¹⁾

⁽¹⁾ Centre for Environment, Fisheries and Aquaculture Science (CEFAS), Lowestoft, UK, NR33 0HT. kate.collingridge@cefas.co.uk

⁽²⁾ Institute for Estuarine and Coastal Studies, University of Hull, Hull, UK, HU6 7RX

⁽³⁾ DHI, 2970 Hørsholm, Denmark

Abstract

High-quality geo-referenced in situ samples are invaluable for the validation of biogeochemical models (Ford et al. 2017) and satellite ocean colour products (Ruddick et al. 2016). Here, we present a description of a database of 636 phytoplankton pigment samples from a variety of cruises. Geographically, the sampling extent covers two important shelf sea areas: the North Sea using gridded sampling on summer International Bottom Trawl Survey cruises between 2010 and 2016, and the Celtic Sea using autumn pelagic survey between 2012 and 2016. Water samples were taken from the ferrybox intake of the research vessel “Cefas Endeavour” for surface samples, or from Niskin bottles deployed from a CTD rosette at depth. Samples were filtered on GFF and frozen immediately in liquid nitrogen or at -80° C before shipment to the international pigment laboratory at DHI. Results were quality controlled after Aiken et al. (2009) and entered into a relational database. The HPLC-derived chlorophyll a was used to convert fluorescence from the vessel’s ferrybox fluorometer on a per cruise basis. This enabled the use of data from the high-frequency autonomous instruments to be used to provide chlorophyll estimates along the ship route at the surface. The quality-controlled data can be incorporated into ecosystem assessments (e.g. MSFD), and are used to validate chlorophyll estimates derived from remote sensing where matchups are available.

1. Introduction

Chlorophyll *a* is an important parameter providing a measure of phytoplankton biomass, and is used for many purposes, including MSFD assessments, and input into ecosystem and food web models with a wide range of uses. Chlorophyll concentration is estimated using a variety of methods, of which HPLC is the most comprehensive technique, also providing concentrations of the whole suite of phytoplankton pigments, which can be used to identify phytoplankton functional types.

Increasingly, autonomous instruments are used to measure chlorophyll by conversion from fluorescence. These can provide data at a higher spatial or temporal resolution, however it has been shown that the relationship between fluorescence and chlorophyll is not constant and varies widely depending on location, season or other factors affecting the phytoplankton community (Roesler *et al.*, 2017). Therefore, in addition to standard manufacturer calibrations of instruments, regular collection of in situ chlorophyll samples are necessary to convert fluorescence to chlorophyll and make full use of available fluorescence data. Similarly, chlorophyll concentrations derived from remotely sensed ocean colour have the potential to provide estimates of chlorophyll across a broad spatial area, but retrieval algorithms require in situ data for validation especially in optically-complex waters.

2. Methods

T2 litre water samples were taken from the continuous flow ferrybox water supply (4m depth), or from Niskin bottles on a rosette fired at particular depths. Water samples were filtered through a Whatman GFF filter, and immediately frozen in liquid nitrogen (2010-2012) or in a -80°C freezer on board (other years). Pigments were stored at -80°C for 1-4 months then transferred to the analysis laboratory using dry ice. Pigments were analysed by HPLC as described in (Schlüter *et al.*, 2016).

Data quality control was performed after Aiken *et al.*, 2009. Samples were removed if they had insufficient chlorophyll (<0.04µg/l), a ratio of above 0.5 of degradation pigments to chlorophyll *a*, a difference between total chlorophyll *a* (TChl*a*) and accessory pigments (AP) of more than 40% of the total pigments, or if regression of TChl*a* to AP for the cruise was poor ($r^2 < 0.7$, slope <0.7 or <1.5).

Chlorophyll *a* from HPLC was used to calibrate fluorescence measurements from the ferrybox for the summer North Sea survey and autumn Celtic Sea survey on RV Cefas Endeavour. Matchups with ferrybox were done based on time, using a five-minute average of ferrybox fluorescence. The relationship between total chlorophyll *a* and fluorescence (using a log-log linear regression for each cruise) was then used to convert fluorescence to chlorophyll *a*.

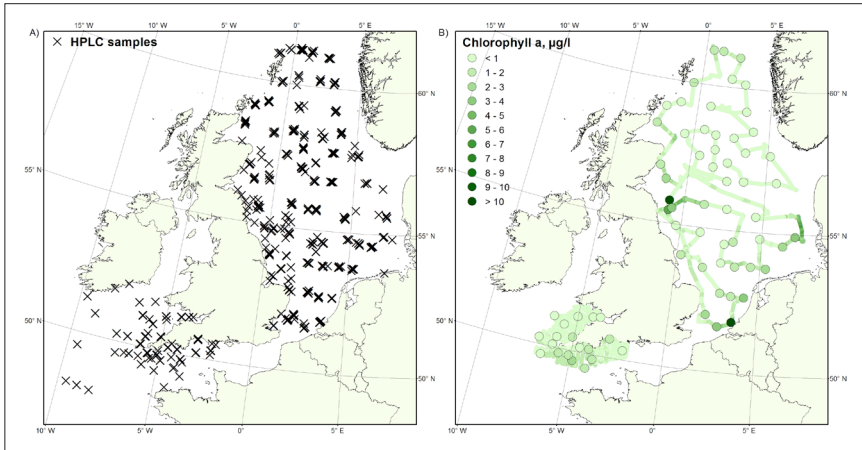

Fig. 1. (a) Location of HPLC samples for 2010-2016. (b) Chlorophyll a concentrations at sampled stations in 2014, with converted chlorophyll from ferrybox fluorescence. In the North Sea, the cruise was in August, and in the Celtic Sea/English Channel the cruise was in October.

3. Results and conclusions

636 HPLC pigment samples from the North and Celtic seas were collected and passed QC (Fig. 1A). The relationship between fluorescence and chlorophyll was found to be highly variable, with slopes between 0.6 and 23. Differences were not found to be due to season or sea area, however, ratios of diatom to dinoflagellate diagnostic pigments explained 34% of variation in slope.

One problem encountered was that there are several cases in our dataset where all analysed HPLC samples had low chlorophyll concentrations and fluorescence, yet during the cruise high fluorescence was observed between stations. Unless these blooms are deliberately targeted and sampled it is impossible to know whether the relationship between fluorescence and chlorophyll applies at higher values encountered by the Ferrybox.

Acknowledgements

The pigment analyses were funded by: DEVOTES (FP7-environment, 308392), HIGHROC (FP7-space, 606797), DYMAPHY (Interreg 4A-2seas), and PROTOOL (FP7-environment, 226880); POSEIDON (Defra, Dr. Jeroen van der Kooij) and national monitoring programme for Eutrophication (David Sivyer). Thanks also to the colleagues who collected samples on the RV Cefas Endeavour.

References

Aiken J., Pradhan Y., Barlow R., Lavender S., Poulton A., Holligan P., & Hardman-Mountford N. (2009). Phytoplankton pigments and functional types in the Atlantic Ocean: A decadal assessment, 1995-2005. *Deep-Sea Research Part II: Topical Studies in Oceanography*, 56, 899-917.

Roesler C., Uitz J., Claustre, H. E. Boss, E. Xing, X. Organelli E., ... Barbieux M. (2017). Recommendations for obtaining unbiased chlorophyll estimates from *in situ* chlorophyll fluorometers: A global analysis of WET Labs ECO sensors. *Limnology and Oceanography*, 15.

Schlüter L., Behl S., Striebel M. and Stibor H. (2016). Comparing microscopic counts and pigment analyses in 46 phytoplankton communities from lakes of different trophic state. *Freshwater Biology*, 61, 1627-1639.

EFFECTIVE VERTICAL MIXING OVER A DEEP BASIN VIA THE USE OF AN ARGO FLOAT

N. Krauzig⁽¹⁾, V. Zervakis⁽²⁾, E. Tragou⁽³⁾ and E. Krasakopoulou⁽⁴⁾

⁽¹⁾ Department of Marine Sciences, University of the Aegean, 81100 Mytilene, Greece.
E-mail: marm16008@marine.aegean.gr

^(2,3,4) Department of Marine Sciences, University of the Aegean, 81100 Mytilene, Greece.

Abstract

Successive CTD profiles of an ARGO float trapped within a deep sub-basin of the North Aegean Sea during 2014-2015 enabled the identification of the deep-water ventilation episodes and the determination of effective vertical eddy diffusivity during the stagnation period that followed these events. The assumption of turbulent mixing between the intermediate and deep water masses led to the identification of a conductivity sensor drift rate of $4.6 \times 10^{-6} \text{ S m}^{-1} \text{ day}^{-1}$. After correcting the sensor's drift, the eddy diffusion coefficients K_r , K_s and K_{σ_θ} were found to range between 2×10^{-4} and $2\text{-}3 \times 10^{-3} \text{ m}^2 \text{ s}^{-1}$ for the deeper than 400m waters. These estimates are at least one order of magnitude higher than eddy diffusivities based on the internal wave strain method, suggesting that open-ocean internal waves cannot maintain the observed mixing rates.

Keywords: vertical mixing, eddy diffusivity, stagnation period, ARGO float

1. Introduction

During stagnation periods between deep-water replenishment events, the evolution of the hydrographic characteristics of the deep waters in the North Aegean is determined by turbulent mixing through the 400m interface with the intermediate layer water mass. Past eddy diffusivity calculations (Zervakis *et al.*, 2003) based on successive CTD casts temporally separated by several months correspond to the effective mixing over time scales of a year or more. Recent numerical simulations by Mamoutos *et al.* (personal communication) indicated that during stagnation periods, an annual cycle might be overlaid on the interannual density decay of the deep basins. However, this result is highly dependent on the selection of the numerical scheme for vertical advection as well as the selection of a turbulence closure scheme. Thus, it is imperative to use new

high-frequency data from the deep layers of the North Aegean in order to examine the behavior of the basin at shorter-than-annual time scales. An excellent opportunity to investigate this question rose, when a profiling ARGO float was trapped within a deep sub-basin of the North Aegean and remained there for about a year. This work exploits the ARGO-derived hydrographic profiles in order (a) to examine whether there is an annual cycle recorded in the deep basins and (b) to produce vertical eddy diffusivity estimates, representing phenomena of shorter time-scales.

2. Results

2.1 Air-sea heat fluxes

Air-sea fluxes (NCEP, NCAR daily reanalysis fields) reveal large heat losses in January and March of 2015 leading to surface water cooling and triggering convection processes in late March, as previously observed in the region (Theocharis and Georgopoulos, 1993; Zervakis *et al.*, 2000). Maximum Mixed Layer Depth (MLD) values, exceeding 200 m, are observed in late March (using a 0.125 kg m^{-3} density threshold criterion), following the heat-loss event (Fig. 1).

2.2 Evolution of deep-waters throughout 2014-2015

The layer below 600m does not appear to have been affected by a seasonal cycle during the winter of 2014-2015. On the contrary, the spatial mean of the deeper-than-400m waters exhibits an intermittent rise in density from October 2014 until March 2015, a fact signifying that the deep layers are ventilated in a rather continuous fashion by shelf formation rather than open-sea convection. The period following the beginning of April 2015 until October 2015, characterized by a gradual decrease of the spatial mean density for the deeper-than-600m waters is identified as a stagnation period for the deep layer.

2.3 Vertical mixing during stagnation period based on the corrected data

Preliminary analysis revealed a gradual positive drift of the conductivity sensor. Removal of the linear trend leads to a much improved cumulative θ/S diagram and to identical eddy diffusivities (estimated as in Zervakis *et al.*, 2003, using float data instead of CTD casts) as shown in Fig. 2 right below.

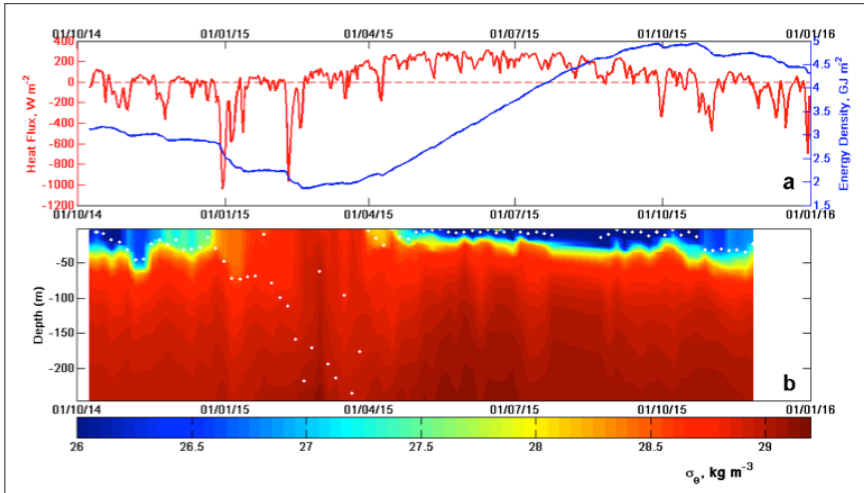

Fig. 1. (a) Net vertical heat flux (red) through the air-sea interface throughout late 2014-2015, averaged over the North Sporades basin. Superimposed is the accumulated heat density gain by the sea (blue curve). (b) Evolution of density along the path of the ARGO float, within the upper 250m of the water column. The mixed-layer depth estimate is presented by the white bullets. Sea/English Channel the cruise was in October.

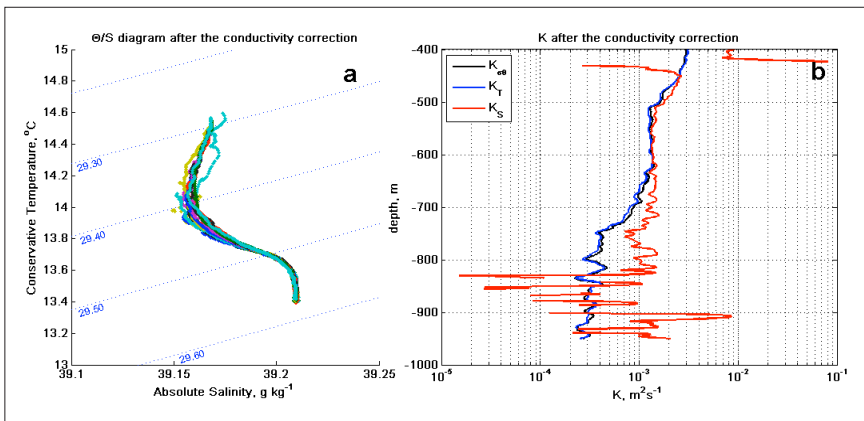

Fig. 2. (a) θ/S diagram from the range of depths 400m – seabed, obtained from all the ARGO float profiles within the stagnation period. (b) Vertical eddy diffusivity of temperature (K_T), salinity (K_S) and potential density anomaly ($K_{\sigma\theta}$) using the “corrected” ARGO float data.

References

Theocharis A. and D. Georgopoulos (1993), Dense water formation over the Samothraki and Limnos Plateaux in the north Aegean Sea (Eastern Mediterranean Sea), *Continental Shelf Research*, 13, 919–939.

Zervakis V., D. Georgopoulos and P.G. Drakopoulos (2000), The role of the North Aegean in triggering the recent Eastern Mediterranean climatic changes, *J. Geophys. Res.*, 105, 26103–26116.

Zervakis V., E. Krasakopoulou, D. Georgopoulos and E. Souvermezoglou (2003), Vertical diffusion and oxygen consumption during stagnation periods in the deep North Aegean, *Deep Sea Research Part I: Oceanographic Research Papers*, 50, 53–71.



**PROCESSES,
MODELLING AND
FORECAST**



THE ARCTIC MARINE FORECASTING CENTRE OF THE COPERNICUS MARINE SERVICES

L. Bertino ⁽¹⁾, A. Ali ⁽¹⁾, A. Carrasco ⁽²⁾, A. Melsom ⁽²⁾, M. Müller ⁽²⁾, A. Samuelsen ⁽¹⁾, G. Sutherland ⁽²⁾, T. D. Williams ⁽¹⁾ and J. Xie ⁽¹⁾

⁽¹⁾Nansen Environmental and Remote Sensing Center, Thormøhlensgate 47, 5006, Bergen, Norway

Abstract

The Arctic Marine Forecasting Center (ARC MFC) provides 10-days forecasts of the ocean currents, sea ice, marine biogeochemistry and waves on a daily basis and a 25 years reanalysis of the Arctic Ocean updated every year. The ARC MFC is powered by the Topaz configuration of the HYCOM model, coupled to the sea ice model CICE, the ecosystem model ECOSMO, and assimilating the following data with the Ensemble Kalman Filter: along-track sea level anomalies, sea surface temperatures, sea ice concentrations, sea ice drift, sea ice thickness and in situ temperature and salinity profiles. Waves are forecasted using an Arctic configuration of the WAM model. We review the main achievements of the ARC MFC during the first 3 years of the services and the plans for its future developments.

Keywords: ocean, analysis, forecasting, research, physics, biogeochemistry, applications extensions

1. System overview

The Arctic Marine Forecasting Center (ARC MFC) has inherited from the Topaz system developments initiated with the EU DIADEM and TOPAZ projects from 1999 to 2003, then followed by the MERSEA IP (2004-2008) and successive MyOcean projects (2009-2015). In parallel to the latter, the MyWave project (2012-2014) has further developed the WAM wave model. Both Topaz and WAM are since 2015 the main components of the Copernicus Marine Environment Monitoring Services (CMEMS) for modelling and forecasting the Arctic.

The ARC MFC is covering the Nordic Seas and Arctic Ocean North of 63N with forecast of the ocean and sea ice physics, waves and ocean biogeochemistry. Ocean physical and biological reanalyses (25 years and 4 years respectively) are also provided. All use the Ensemble Kalman Filter (EnKF) to assimilate different types of satellite and in situ observations (Sakov *et al.*, 2012, Xie *et al.*, 2017).

The ocean model is a regional configuration of the Hybrid Coordinate Ocean Model (HYCOM, Bleck 2002) and coupled with a dynamic-thermodynamical sea ice model (CICE) and two ecosystem models (NORWECOM and ECOSMO). The use of a dynamical EnKF was motivated by the problem of coupled ice-ocean assimilation (Lisæter *et al.*, 2003) and the ability to estimate biological model parameters when assimilating biological observations (Simon *et al.*, 2015, Gharamti *et al.*, 2017) and then generalized as the technique that assimilates all types of observations consistently using the same representation of the uncertainty, using one single ensemble. The waves are forecasted by an Arctic polar-stereographic configuration of the WAM model at 8km resolution.

2. Ocean physics

A steady increase of the resolution of forecasting systems is necessary to keep up with the state of the art. Since the ARC MFC data assimilation integrates 100 dynamical members, the available computing facilities have so far restricted the choice of the model resolution to about 12km horizontally and 28 hybrid vertical layers. In the course of the first phase of CMEMS, the ARC MFC is doubling both its horizontal and vertical resolution, and the domain can be restricted to the Northern latitudes, taking benefit from lateral boundary conditions from the global NEMO system (GLO MFC). This increase of resolution is expected to resolve better the narrow topographically-steered currents in the Nordic Seas and Arctic Ocean. The new domain will as well include the Bering Sea in the Pacific Ocean.

3. Biogeochemistry

The ARC MFC has implemented a chlorophyll component in the ECOSMO model following the formulation from Bagniewski *et al.*, (2011). This replaces a fixed diagnosis of chlorophyll from the phytoplankton biomass and is intended to improve the assimilation of satellite retrievals of chlorophyll from CMEMS.

4. Waves and sea ice

The inclusion of waves in CMEMS provides a historical opportunity to include wave terms into the ocean surface circulation as well as the wave processes that shape the Marginal Ice Zone (MIZ).

As part of the Retrospect project funded by the Research Council of Norway, the following wave-to-ocean terms have been implemented in HYCOM, following the SHOM implementation (R. Baraille, pers. comm.): the Coriolis-Stokes drift, the surface stress due to wave generation and decay, and the wave induced mixing by Langmuir cells. The Coriolis-Stokes drift uses a deep-water approximation of the Stokes profile based on the Phillips Spectrum (Breivik *et al.*, 2016), which conserves the wave momentum to be fed to the ocean mean flow. Four different parameterizations of the Langmuir cells are being evaluated. These wave-to-ocean terms are expected to improve the prediction of drift of surface objects, including the drift of biological material.

When waves reach the sea ice, the mechanical flexure efforts breaks the ice into smaller floes, which in turn attenuate the waves by both scattering and dissipation processes. The waves-in-ice model proposed by Williams *et al.*, (2013) includes the above effects and has been implemented and tested in HYCOM (see Fig. 1 for an example extracted from a near-real-time - NRT - experiment using the WAVEWATCH III model from Ifremer as input). The resulting predictions of waves in ice and floe size are relevant to the offshore industry, which is more likely to work in the MIZ than in heavier ice pack conditions. The wave-in-ice model is also being introduced into the Lagrangian-coordinates sea ice model neXtSIM (Williams *et al.*, 2017).

5. Reanalysis

A comparison of the reanalyses from the ARC MFC, GLO MFC and a non-assimilative ROMS Arctic hindcast has revealed that data assimilation was improving the water and heat fluxes between the North Atlantic and the Arctic both in the ARC and the GLO MFCs (Lien *et al.*, 2016).

Marine ecosystems offer a challenging test bed for data assimilation methods. One important aspect of biogeochemical modelling is the strong dependency on unknown ecosystem model parameters for the prediction of the ecosystem. The ARC MFC has previously shown the advantages of using a dynamical ensemble Kalman Filter for updating jointly the unobserved 3-dimensional ecosystem variables and the unknown model parameters, and as well of using a Gaussian anamorphosis to account for their non-Gaussian probability distributions (Simon *et al.*, 2012, 2015). As part of the CMEMS work, it was more recently proven that a smoother approach was necessary in addition to control the unknown parameters during the blooms (Gharamti *et al.*, 2017a). These data assimilation advances are now being used jointly in the production of the V4 biological reanalysis of the ARC MFC assimilating Chlorophyll data and in situ profiles of nutrients from CMEMS.

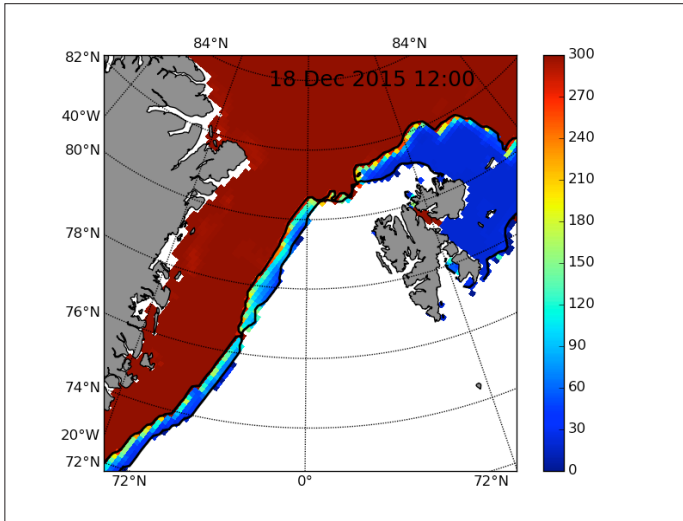

Fig. 1. Maximum floe size predicted by the model on 18th Dec 2015 following the passage of a storm. The ice pack is represented in red, the MIZ defined by the action of waves has a variable floe size up to 300 m.

6. Product Quality Assessment

Measuring the skills of a sea ice forecast requires some user-defined metrics: since most navigators would like to remain safely outside of the ice edge, the distance to the ice edge has been used as an intuitive way to quantify and compare sea ice forecast skills in the ARC MFC and GLO MFC (Fig. 2).

The ARC MFC physical ocean reanalysis provides one of the most extensive demonstrations of an ensemble data assimilation to date, and an opportunity to challenge the convergence of the EnKF. Xie *et al.*, (2017) have used diagnostics of the Reduced-Centered Random Variable and show that the EnKF remained reliable throughout the 1200 assimilation cycles of the reanalysis and that the solution was balancing well the different observations assimilated (none of the six different remote sensing and in situ data types was assimilated at the expense of the others).

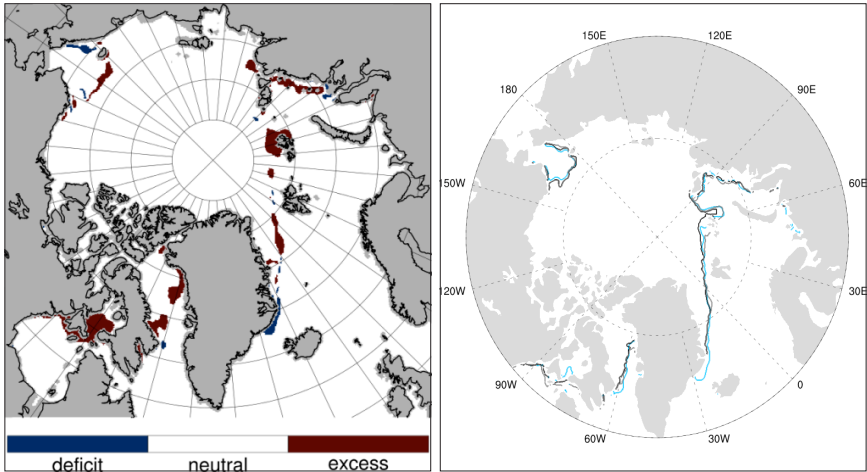

Fig. 2. Maps displaying regions with deficit and excess of sea ice of at least 25% (left) and ice edge delineation from OSI SAF observations, forecast and model best estimate (right). Figures available from <http://cmems.met.no>

7. The assimilation of sea ice thickness

The value of assimilating sea-ice thickness measurements for short term forecasting has been evaluated by Xie *et al.*, (2016). Even though only measurements of ice thinner than 40cm were retained, the SMOS data proved beneficial to forecast thicker ice, as well as a slight improvement of sea ice concentrations. The assimilation updated jointly ocean and sea-ice variables and was not detrimental to ocean properties. The SMOS ice thickness data are scheduled for assimilation into the NRT system in mid-October 2017. The combined SMOS-CryoSAT2 data from AWI is also assimilated in the V4 version of the physical reanalysis.

8. Impact of r&d advances for users and applications

- **Weather, seasonal and climate.** Although CMEMS targets shorter time scales than the climate modelling community, the developments of the ARC MFC system shares common conceptual and software components with the Norwegian Climate Prediction Model (NorCPM): both use isopycnal vertical coordinates (both in MICOM and HYCOM) apply the EnKF for data assimilation, a coupling to the CICE sea ice model and the OSA EnKF for the biogeochemical component (Counillon *et al.*, 2016, Gharamti *et al.*, 2017b). These methodological exchanges could be exploited in future seamless predictions from days to decades, which have a strong appeal to those using both NRT and climate forecasts.
- **Marine resources (fishery and aquaculture).** The monitoring of fish stocks is relying on good simulations drift of biological material at the ocean surface, would it be for the availability of nutrients and plankton at the basis of the food web or the nearly passive drift of fish larvae. Ocean temperature is also an important condition to the early stages of fish development in high latitudes (Stige *et al.*, 2015). Improvements of the surface currents and vertical mixing are therefore in focus for the next version of the ARC MFC.
- **Offshore industry and Marine Renewable Energies.** The Arctic Response Technology Joint Industry Project has emphasized the importance of knowing the diffusive properties of the sea ice dynamics in view of forecasting the fate of hypothetical oil spills trapped in the ice. Rampal *et al.*, (2016) have evaluated such properties in the classical sea ice model used in the ARC MFC to the neXtSIM model using a more advanced Maxwell Elastic-Brittle rheology and showed that neXtSIM had the most realistic diffusive properties. This makes a strong incentive for using neXtSIM in the next phase of the ARC MFC.
- **Marine Safety and maritime transport.** The shipping industry relies on e-Navigation services (optimal routing) that must be continuous from harbour to harbour (B. Å. Hjøllo, NAVTOR AS). This continuity requires a dynamical downscaling approach from the GLO MFC to all regional MFCs, which is being practiced more and more broadly across the CMEMS MFCs.

Acknowledgements

The authors acknowledge the CMEMS Phase 1 contract for the Arctic MFC. Additionally, the EU FP7 SWARP project has contributed complementary research on waves-in-ice coupling, the RETROSPECT project from the Research Council of Norway on waves-ocean interactions. Grants of computing time (nn2993k) and storage (ns2993k) from the Norwegian Sigma2 infrastructures are also gratefully acknowledged, as well as computing time from the PRACE-DECI project BHAO.

References

- Bagniewski, W., Fennel, K., Perry, M.J., D'Asaro, E.A., 2011. Optimizing models of the North Atlantic spring bloom using physical, chemical and bio-optical observations from a Lagrangian float. *Biogeosciences* 8, 1291–1307. doi:10.5194/bg-8-1291-2011
- Bleck, R., 2002. An oceanic general circulation model in pressure coordinates. *Ocean Modelling*, 37, 55.88. [http://doi.org/doi:10.1016/S1463-5003\(01\)00012-9](http://doi.org/doi:10.1016/S1463-5003(01)00012-9)
- Breivik, Ø., Bidlot, J. R., & Janssen, P. A. E. M., 2016. A Stokes drift approximation based on the Phillips spectrum. *Ocean Modelling*, 100, 49–56. <http://doi.org/10.1016/j.ocemod.2016.01.005>
- Counillon, F., Keenlyside, N., Bethke, I., Wang, Y., Billeau, S., Shen, M. L. and Bentsen, M., 2016. Flow-dependent assimilation of sea surface temperature in isopycnal coordinates with the Norwegian Climate Prediction Model. *Tellus A*, 68, 1–17. <http://doi.org/10.3402/tellusa.v68.32437>
- Gharamti, M. E., Samuelsen, A., Bertino, L., Simon, E., Korosov, A., & Daewel, U., (2017a). Online tuning of ocean biogeochemical model parameters using ensemble estimation techniques: Application to a one-dimensional model in the North Atlantic. *Journal of Marine Systems*, 168, 1–16. <http://doi.org/10.1016/j.jmarsys.2016.12.003>
- Gharamti, M. E., Tjiputra, J., Bethke, I., Samuelsen, A., Skjelvan, I., Bentsen, M., & Bertino, L., (2017b). Ensemble data assimilation for ocean biogeochemical state and parameter estimation at different sites. *Ocean Modelling*, 112, 65–89. <http://doi.org/10.1016/j.ocemod.2017.02.006>
- Lien, V. S., Hjøllø, S. S., Skogen, M. D., Svendsen, E., Wehde, H., Bertino, L., Counillon F, Chevallier M, Garric, G., 2016. An assessment of the added value from data assimilation on modelled Nordic Seas hydrography and ocean transports. *Ocean Modelling*, 99, 43–59. <http://doi.org/10.1016/j.ocemod.2015.12.010>
- Lisæter, K. A., Rosanova, J., & Evensen, G., 2003. Assimilation of ice concentration in a coupled ice-ocean model, using the Ensemble Kalman filter. *Ocean Dynamics*, 53(4), 368–388. <http://doi.org/10.1007/s10236-003-0049-4>
- Rampal, P., Bouillon, S., Bergh, J., & Ólason, E., 2016. Arctic sea-ice diffusion from observed and simulated Lagrangian trajectories. *The Cryosphere*, 10(4), 1513–1527. <http://doi.org/10.5194/tc-10-1513-2016>

Sakov, P., Counillon, F., Bertino, L., Lisæter, K. A., Oke, P. R., and Korablev, A., 2012. TOPAZ4: an ocean-sea ice data assimilation system for the North Atlantic and Arctic. *Ocean Science*, 8(4), 633–656. <http://doi.org/10.5194/os-8-633-2012>

Simon, E., & Bertino, L., 2012. Gaussian anamorphosis extension of the DEnKF for combined state parameter estimation: Application to a 1D ocean ecosystem model. *Journal of Marine Systems*, 89(1), 1–18. <http://doi.org/doi:10.1016/j.jmarsys.2011.07.007>

Simon, E., Samuelsen, A., Bertino, L., & Mouysset, S., 2015. Experiences in multiyear combined state-parameter estimation with an ecosystem model of the North Atlantic and Arctic Oceans using the Ensemble Kalman Filter. *Journal of Marine Systems*, 152, 1–17. <http://doi.org/10.1016/j.jmarsys.2015.07.004>

Stige, L. C., Langangen, Ø., Yaragina, N. A., Vikebø, F. B., Bogstad, B., Ottersen, G., Hjermann, D., 2015. Combined statistical and mechanistic modelling suggests food and temperature effects on survival of early life stages of Northeast Arctic cod (*Gadus morhua*). *Progress in Oceanography*, 134, 138–151. <http://doi.org/10.1016/j.pocean.2015.01.009>

Williams, T. D., Bennetts, L. G., Squire, V. A., Dumont, D., & Bertino, L., 2013. Wave-ice interactions in the marginal ice zone. Part 2: Numerical implementation and sensitivity studies along 1D transects of the ocean surface. *Ocean Modelling*, 71, 92–101. <http://doi.org/10.1016/j.ocemod.2013.05.011>

Williams, T. D., Rampal, P., and Bouillon, S., 2017: Wave-ice interactions in the neXtSIM sea-ice model, *The Cryosphere*, 11, 2117-2135, <https://doi.org/10.5194/tc-11-2117-2017>

Xie, J., Bertino, L., Counillon, F., Lisæter, K. A., & Sakov, P., 2017. Quality assessment of the TOPAZ4 reanalysis in the Arctic over the period 1991–2013. *Ocean Science*, 13(1), 123–144. <http://doi.org/10.5194/os-13-123-2017>

Xie, J., Counillon, F., Bertino, L., Tian-Kunze, X., & Kaleschke, L., 2016. Benefits of assimilating thin sea-ice thickness from SMOS into the TOPAZ system. *The Cryosphere*, 10 (November), 2745–2761. <http://doi.org/10.5194/tc-10-2745-2016>

RELOCATABLE OCEAN MODELLING FOR DOWNSCALING TO THE SHELF AND COASTAL AREAS

F. Trotta⁽¹⁾, N. Pinardi⁽¹⁾, S. Masina⁽²⁾, G. Coppini⁽²⁾, D. Iovino⁽²⁾,
S. A. Ciliberti⁽²⁾, R. Lecci⁽²⁾, A. Storto⁽²⁾, A. Cipollone⁽²⁾, F. Montagna⁽²⁾, S. Creti⁽²⁾,
F. Palermo⁽²⁾, G. Turrise⁽²⁾, L. Stefanizzi⁽²⁾ and M. Francesca⁽²⁾

⁽¹⁾ Department of Physics and Astronomy, Alma Mater Studiorum University of Bologna, Italy

⁽²⁾ Fondazione Centro Euro-Mediterraneo sui Cambiamenti Climatici (CMCC), Italy

Abstract

A new operational service is being developed for the provision of high resolution oceanographic forecast data for safety of offshore operations. The service includes the provision of high-resolution ocean sea level, currents, temperature and salinity forecasts at $1/64^\circ$ resolution in the following areas: Gulf of Mexico, Caribbean Sea, Britain, Mediterranean, Black Sea, Caspian Sea, Red Sea, Guinea Gulf, Angola, Mozambique, South China Sea and Australia.

The nested model is the Structured and Unstructured grid Relocatable ocean platform for Forecasting (SURF, Trotta et al., 2016) that is a modelling system rapidly deployable in any world ocean region based upon the NEMO code. The present implementation considers the nesting of SURF in the large-scale Global Ocean Forecasting System (GOFS16) at $1/16^\circ$ resolution (Iovino et al., 2016, 2017) and a horizontal grid resolution of $1/64^\circ$ with about 100 vertical levels.

Keywords: relocatable ocean model, nested ocean model

1. Introduction

The Structured and Unstructured Relocatable ocean model for Forecasting, SURF, (Trotta *et al.*, 2016) provides a numerical platform for the short-time forecasts of hydrodynamic and thermodynamic ocean fields in limited regions at high spatial and temporal resolutions. The system is designed to be nested in any portion of a large-scale ocean prediction system and can be rapidly implemented in any region of the world by taking specific choices of model parameters with respect to the nesting model. It represents a component of an advanced decision support system to increase safety of offshore operations, oil spill forecasting, search and rescue operations, navigation routing such as described by Coppini *et al.*, (2017).

SURF has been already implemented in various regions in the Mediterranean Sea where it has been coupled with the large-scale ocean prediction system, called Mediterranean Forecasting System-MFS (Pinardi and Coppini, 2010). In the Tuscan Archipelago during the Serious Game oceanographic campaign carried out from 17 to 21 May 2014 (Trotta *et al.*, 2016) and in the Gulf of Taranto during the Mrea14 campaign from 1 to 11 October 2014 (Trotta *et al.*, 2017). Using the CTD data collected during the observational surveys, SURF has been shown to improve the forecasts and simulations compared to the coarse-resolution MFS model.

The aim of this study is to realize a new operational oceanography service which will provide operational forecasts of the circulation in several areas of the world with horizontal grid resolutions $1/64^\circ$ and about 100 vertical levels, starting from $1/16$ and 98 levels GOF16 forecasts and analyses. Fig. 1 shows the SURF model domain of all proposed areas.

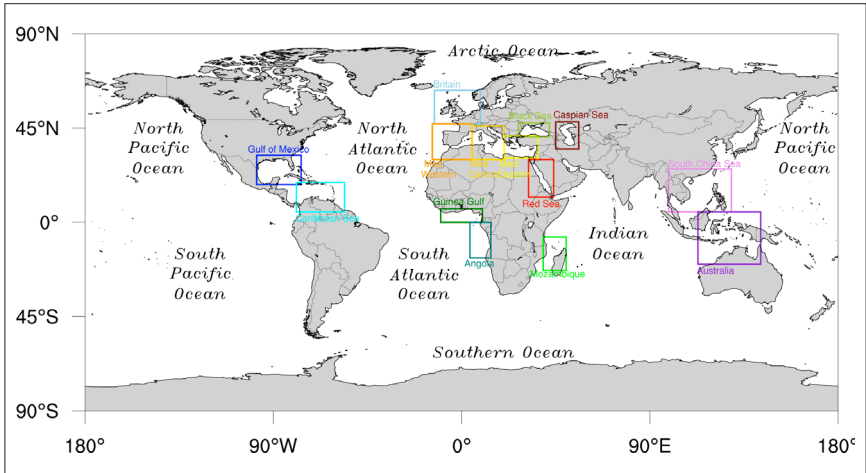

Fig. 1. The fourteen SURF model domains: Gulf of Mexico, Caribbean Sea, Britain, Mediterranean (western, central and eastern), Black Sea, Caspian Sea, Red Sea, Guinea Gulf, Angola, Mozambique, South China Sea and Australia.

2. Nested-Grid Ocean Circulation Modelling System

SURF provides a numerical platform for the short-time forecasts of hydrodynamic and thermodynamic fields in limited regions at high spatial and temporal resolutions. In this application it is nested in 14 regions of a large-scale Global Ocean Forecasting System at $1/16^\circ$ resolution (GOF516; Iovino *et al.*, 2016, 2017). The parent coarse-grid model provides initial and lateral boundary conditions for the SURF child model application. SURF requires an initial spin up period from a few days to a week in order to develop the new dynamical structures allowed by the higher resolution starting from the initial interpolated fields of the parent model. The SURF workflow connects the NEMO simulation code (Madec, 2008) to several pre- and post-processing procedures, making each platform component easy to deploy in a limited region which is part of the parent model domain where SURF is nested.

NEMO solves the three-dimensional (3D) primitive free-surface ocean equation under hydrostatic and Boussinesq approximations along with turbulence closure schemes and a nonlinear equation of state, which couples the two active tracers (temperature and salinity) to the fluid velocity. The 3D space domain is discretised by an Arakawa-C grid where the model state variables are horizontally and vertically staggered. In the vertical direction, we use stretched z-coordinates distributed along the water column, with appropriate thinning designed to better resolve the surface and intermediate layers and partial cells parameterisation in order to fit the real bathymetry.

Density is computed according to Jackett and McDougall's nonlinear equation of state. A horizontal biharmonic operator was used for the parameterisation of lateral subgrid-scale mixing for both tracers and momentum. The horizontal eddy diffusivity and viscosity coefficients were parameterised as a function of the parent coarse resolution model. If a_0 is the parent biharmonic viscosity or diffusivity, the nested model equivalent coefficient is initially set to $a = a_0 (\Delta x_F / \Delta x_L)^4$, where Δx_F is the nested, SURF grid spacing and Δx_L is the large-scale, parent model grid resolution.

The vertical eddy viscosity and diffusivity coefficients were computed following the Pacanowsky and Philander's Richardson number-dependent scheme. For cases where unstable stratification is a possibility, a higher value ($10 \text{ m}^2/\text{s}$) is used for both the viscosity and diffusivity coefficients.

The Monotonic Upstream Scheme for Conservation Laws (MUSCL) is used for the tracer advection and the Energy and Enstrophy conservative (EEN) scheme is used for the momentum advection. No-slip conditions on closed lateral boundaries are applied and the bottom friction is parameterised by a quadratic function. The surface air-sea fluxes are computed through the CORE formulas as implemented in GOFs16.

The open boundary conditions are: for the barotropic velocities, the Flather scheme is used, while for the baroclinic total velocities, active tracers and sea surface height, the flow relaxation scheme is used. In the future all these choices will be managed by a machine learning algorithm that will choose the best values of the free model parameterizations for the child model.

3. Conclusions

An innovative oceanographic service has been implemented in several regional and coastal areas of the world ocean at $1/64^\circ$ resolution using the Structured and Unstructured Relocatable ocean model for Forecasting-SURF based on the NEMO code. SURF is nested within the GOFs16 global ocean operational forecasting model and can produce 5 days forecasts every day. The high-resolution ocean forecast data will be provided to the offshore oil spill companies in order to define optimal and safer conditions of work at sea and in the future establish risk and hazard mapping.

References

- Coppini, G., Marra, P., Lecci, R., Pinardi, N., Creti, S., Scalas, M., Tedesco, L., D'Anca, A., Fazioli, L., Olita, A., Turrisi, G., Palazzo, C., Aloisio, G., Fiore, S., Bonaduce, A., Kumkar, Y. V., Ciliberti, S. A., Federico, I., Mannarini, G., Agostini, P., Bonarelli, R., Martinelli, S., Verri, G., Lusito, L., Rollo, D., Cavallo, A., Tumolo, A., Monacizzo, T., Spagnulo, M., Sorgente, R., Cucco, A., Quattrocchi, G., Tonani, M., Drudi, M., Nassisi, P., Conte, L., Panzera, L., Navarra, A., and Negro, G.: *SeaConditions*, 2017. A web and mobile service for safer professional and recreational activities in the Mediterranean Sea, *Nat. Hazards Earth Syst. Sci.*, 17, 533-547, <https://doi.org/10.5194/nhess-17-533-2017>.
- Iovino, D., Masina, S., Storto, A., Cipollone, A., and Stepanov, V. N. (2016). A 1/16° eddy simulation of the global NEMO sea-ice-ocean system, *Geosci. Model Dev.*, 9, 2665-2684, 2016.
- Iovino et al., (2017). The CMCC global ocean forecast system (GOFS16) and relocatable regional downscaling. JCOMM-5 - TECO
- Madec, G. (2008). NEMO ocean engine. *Note du Pole de modélisation, Institut Pierre-Simon Laplace (IPSL), France, Note 27*, ISSN 1288-1619, pp 209.
- Pinardi, N. and Coppini, G. (2010). Operational oceanography in the Mediterranean Sea: the second stage of development. *Ocean Sci.*, 6, 263-267.
- Trotta, F., Fenu, E., Pinardi, N., Bruciaferri, D., Giacomelli, L., Federico, I., Coppini, G. (2016). A Structured and Unstructured grid Relocatable ocean platform for Forecasting (SURF), *Deep-Sea Research Part II: Top. Stud. Oceanogr.*, 133, pp. 54-75.
- Trotta, F., Pinardi, N., Fenu, E. and Grandi A. (2017). Multi-nest high resolution model of submesoscale circulation features in the Gulf of Taranto, *Ocean Dynamic*, under review.

PERFORMANCE AND QUALITY ASSESSMENT OF THE GLOBAL OCEAN EDDY-PERMITTING PHYSICAL REANALYSIS GLORYS2V4

G. Garric⁽¹⁾, L. Parent⁽¹⁾, E. Greiner⁽²⁾, M. Dréville⁽¹⁾, M. Hamon⁽¹⁾, J.M. Lellouche⁽¹⁾, C. Régnier⁽¹⁾, C. Desportes⁽¹⁾, O. Le Galloudec⁽¹⁾, C. Bricaud⁽¹⁾, Y. Drillet⁽¹⁾, F. Hernandez⁽¹⁾, C. Dubois⁽¹⁾ and P-Y. Le Traon⁽¹⁾

⁽¹⁾ Mercator Ocean, Ramonville St Agne. ggarric@mercator-ocean

⁽²⁾ Collecte Localisation Satellite, Ramonville St Agne

Abstract

The purpose of this paper is to give an overview of the latest Global Ocean Reanalysis (GLORYS) upgrade (GLORYS2V4) produced at Mercator Ocean, performed and disseminated in the framework of Copernicus Marine Environment Monitoring Service (CMEMS; <http://marine.copernicus.eu/>). The reanalysis is run on the altimetry era (1993-2016) at $\frac{1}{4}^\circ$ horizontal resolution and 75 vertical z-levels with the NEMO model and driven at the surface by ERA-Interim reanalysis. The reanalysis system uses a multi-data and multivariate reduced order Kalman filter based on the singular extended evolutive Kalman (SEEK) filter formulation together with a 3D-VAR large scale bias correction. The assimilated observations are along-track satellite altimetry, sea surface temperature, sea ice concentration and in situ profiles of temperature and salinity.

In terms of data assimilation statistics, this new upgrade outperforms the previous version in many aspects. An overview of quality assessment based on GODAE metrics classification gives a general reduction of RMSE (root mean squares error) for essential variables. The particular attention dedicated to altimetry and water masses equilibrium largely improves the representation of global thermo-haline content ending with linear trend of 3.56mm/year for Global Mean Sea Level and a 1.8mm/year for the thermo-steric signal.

Keywords: reanalysis, ocean, global

1. Introduction

A number of efforts have been initiated in recent years and tenths of global ocean reanalysis have already been produced worldwide over different periods and with different objectives; see for instance various Ocean Reanalyses Intercomparison Project (ORA-IP) papers comparing different reanalysis on different topics ((Balmaseda, *et al.*, 2015) (Storto, *et al.*, 2015) (Palmer, *et al.*, 2017)). The GLORYS reanalysis Global Ocean Reanalysis (GLORYS) produced at Mercator Ocean designed and set up in the framework of CMEMS has different operational commitments: (1) Being as close as possible (one year delay maximum) to Near Real Time in order to be a reference for real time application and for the monitoring, the assessment and the reporting on past and present marine environmental conditions (physics and biogeochemistry) (Schuckmann, *et al.*, 2016), (2) delivering boundaries conditions for coastal and regional applications and (3) delivering initial conditions to coupled (seasonal) prediction. These objectives clearly assume a realistic reproduction of climatic signals on the altimeter period (from 1993 until present), with interannual variability and trend (heat and salt content, mass, sea ice & biogeochemistry).

The first section presents the core of the system and the upgrades implemented in latest version (GLORYS2V4 hereafter), how the new system performs against assimilated data is presented in the section 2 and main results for the steric sea level is in section 3.

2. Description of the Glorys System

2.1 Core of the GLORYS system

The GLORYS system at $\frac{1}{4}^\circ$ horizontal resolution is based on the NEMO platform with 75 vertical z-levels coupled to the thermodynamic-dynamic LIM2 sea ice model and driven by ERA-Interim atmospheric reanalysis at the surface. Due to large known biases in precipitations and radiative fluxes at the surface, a satellite-based large-scale correction is applied to the ERA-Interim fluxes. No corrections are applied at high latitudes. No global restoring strategy has been implemented in this system to sea surface salinity or to the sea surface temperature.

The data are assimilated by means of a reduced-order Kalman filter, based on the SEEK formulation with a 3-D multivariate modal decomposition of the forecast error and a 7-day assimilation cycle. A 3D-VAR bias correction method has been implemented to correct large-scale temperature and salinity biases when enough observations are present. Analytical increments are applied smoothly during the analysis cycle with an Incremental Analysis Update.

The following data are assimilated into the system: along track L3 Sea Level Anomalies together with an adjusted version of the CNES-CLS013 Mean Dynamic Topography (MDT), in situ Temperature and Salinity profiles coming from the latest CORA4.1 database (Cabanes *et al.*, 2013), AVHRR sea surface temperature from NOAA and Ifremer/CERSAT sea ice concentration (Ezraty *et al.*, 2007).

2.2 Upgrades implemented in GLORYS2V4

In this new version, specific attention has been devoted to the surface mass flux forcing, global steric signal and initial conditions of water masses. With respect to the previous version, GLORYS2V4 contains a number of improvements, in particular:

- a) A new initial temperature and salinity conditions derived from EN4 (Good, *et al.*, 2013) data base and replacing the Levitus *et al.* (1998) climatology used in the previous system. A method using a robust regression model applied to the EN4 monthly objective analysis allowed to re-built the December 1991 water masses conditions. This method considerably reduced the imbalance between a climatology not centred on the initial date and the steric signal seen by the altimetry in 1992.
- b) The CORA 4.1 in situ database produced by the CORIOLIS centre (Cabanes *et al.*, 2013) is now assimilated (<http://www.coriolis.eu.org/Science/Data-and-Products>). Compared to the CORAv3.3 release, the CORA4.1 database includes the temperature and salinity vertical profiles from the sea mammals database (33 000 profiles from elephant seals), as well as moorings from TAO/RAMA/PIRATA programs and corrections on XBT measurements. This data set has been extensively quality controlled using classical “in situ” quality control procedures. For years 2015 and 2016, the delayed mode database was not available, so that the real-time database produced by the Coriolis data centre was used instead.
- c) The use of the new “CNES-CLS13” MDT product referenced over the 1993-2013 period instead of the “CNES-CLS09” product derived from observations (Rio *et al.*, 2011) that was used in the previous system.
- d) The sparsity of the observation networks (both altimetry and in situ) during the 7-days assimilation window together with and the uncertainties in the MDT estimation on the assimilation window (7 days) are not able to correctly estimate the mean global sea level; we then set to zero the global mean increment of the steric sea surface height during each assimilation windows.
- e) The monthly seasonal climatology river runoff is now inferred from (Dai, *et al.*, 2009). It is a reliable estimate for the world’s 925 largest rivers of continental freshwater discharge in all lands areas except Antarctica and Greenland. In addition, the runoff fluxes coming from Greenland and Antarctica ice sheets and glaciers melting has been built from the Altiberg icebergs database project (Tournadre *et al.*, 2016).

- f) Despite the previous corrections and updates, the global freshwater Budget, still far from being balanced, is still set to zero in the new system. In addition and in order to avoid any mean sea-surface-height drift due to the poor water budget closure, we add a trend of 1.74 mm/year to the runoffs in order to represent somehow the recent estimation of the global water mass addition to the ocean (from glaciers, land water storage, Greenland & Antarctica ice sheets) (Chambers *et al.*, 2017).
- g) Although none global restoring is present, a temperature and salinity restoring towards EN4 products has been added at Gibraltar and Bab-el-Mandeb straits to correctly capture the outflow of Mediterranean and Red seas waters into the Atlantic and Indian oceans. The temperature and salinity 3D-restoring applied below 2000m and poleward 60°S with a representative time scale of 20 years, already present in the previous system, is now made towards the EN4 products.

3. Performance and assessment

The sea surface height GLORYS2V4 reanalysis is very close to altimetric observations and has a good ability to describe the sea level variability. Global and regional trends are also very well reproduced. Along the entire 1993-2015 period, the globally averaged RMSE of the analysed sea level is 5.7cm and the forecast sea level is 0.5cm higher (Fig. 1a).

The global mean sea surface temperature (SST) is close to the AVHRR data observations with a weak (warm) misfit (difference between the forecast and the assimilated observations) of 0.07 °C all along the reanalysis and an RMSE of 0.6°C (Fig. 1b)), essentially located in the north-eastern Atlantic Ocean. The RMSE with the SST *in situ* data decreases drastically with the increasing deployment of the ARGO network. The global positive SST linear trend is highly consistent with AVHRR data. The globally averaged mean surface net heat flux is weakly positive (+ 0.5 W.m²) with a negative trend all along the 1993-2015 periods (not shown).

Thanks to sea ice concentration assimilation, all the sea ice extent temporal variability (seasonal cycle, interannual variability and trend) is well reproduced in GLORYS2V4. Both sea ice extent and volume show a general decrease (resp. increase) in the Arctic Ocean (resp. around Antarctica). Biases and RMSE show a seasonal cycle, with a maximum during summertime, in both hemispheres. Biases are close to zero and RMSE is below 20% in both hemispheres (Fig. 1 c,d), which is largely in the error bars of the observations.

GLORYS2V4 reanalysis has weak (cold) biases in temperature profiles with respect to *in situ* data (less than 0.04°C on average, not shown); the largest biases occurring in the [50m-100m] layer and in the northern Atlantic and Southern oceans. However, the RMSE is increasing towards the surface and can reach up to 0.8°C in the first 100m upper layers (Table 1). The thermal structure largely improves with the deployment of Argo buoys (after 2002), mainly in the upper layers (depth < 300m, Tabl 1) with a bias close to 0°C (not shown) and RMSE against all the *in situ* observations less than 0.7°C over this period (Fig. 1e).

The sea surface salinity (SSS) is generally fresher (less than 0.2 psu) than *in situ* data sets. However, largest surface fresh anomalies are found in tropical areas such as the western Atlantic and Pacific oceans. The RMSE (Fig. 1f) shows persisting surface (fresh anomaly) values with a general salty bias (less than 0.1 psu, not shown) found in the [50m-200m] layer but both features are decreasing with time during the whole period. Positive trends of SSS are seen over most parts of the global ocean. Yet, local negative trends are found in the Arctic Ocean and in the Indonesian Throughflow. This overall positive trend is mitigated by a strong negative trend the first three years of the reanalysis (see next section).

4. Steric sea level

The sea level thermo steric component, which dominates the total steric signal, shows a linear increase of about 1.78 mm/year on the 1993-2015 period (Fig. 2) for the first [0-700m] upper layers in GLORYS2V4. This is nearly twice the values found with the *in situ* data (Fig. 2). The halo steric for the first [0-700m] upper layers, fairly negligible, shows a null trend with, however, substantial variability prior to 2004. The trend found in the thermo steric for the entire water column, almost completely explained by the first [0-700m] upper layers, is also larger than the one found recently by Chambers *et al.*, (2017) (Table II). However the trend of the GMSL (Global Mean Sea level) found with GLORYS2V4 is largely in error bars of Chambers *et al.*, (2017). The negative trend found in the GLORYS2V4 halo steric signal is almost entirely due to the drift of bottom layers (deeper than 2000m depth).

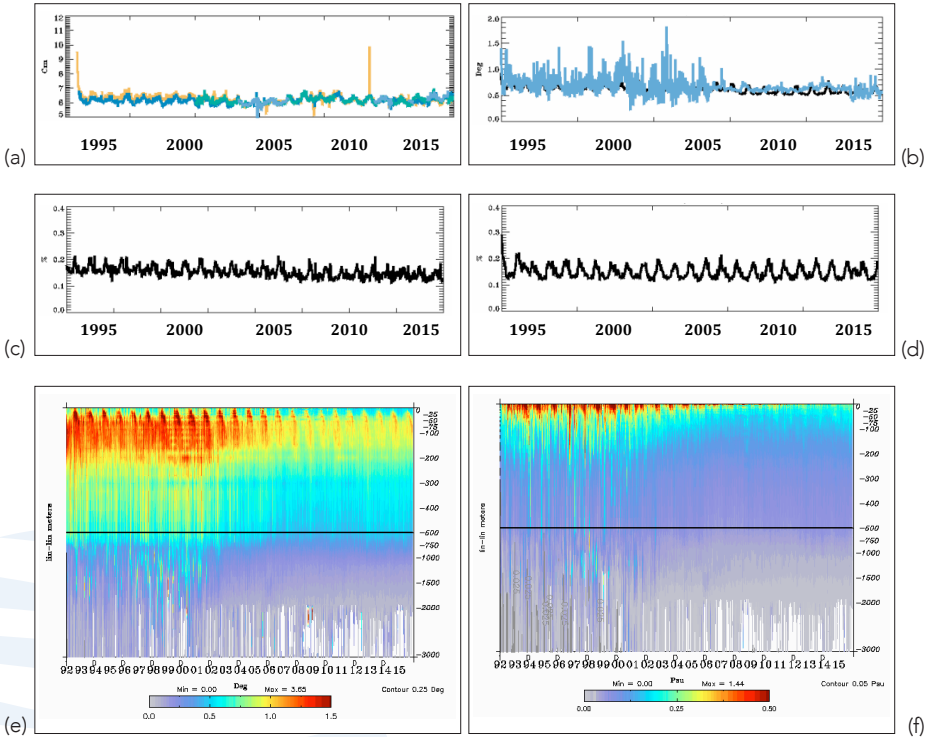

Fig. 1. Time series 1993-2015 of the globally averaged RMSE (innovation domain) of the misfit for a) the sea level (in cm), colours represent different altimetry satellites (ERS, T/P, Jason 1 & 2, Envisat, GFO, Saral/AltiKa, Cryosat2, HY2A). b) the SST (in °C), in black the AVHRR data and in blue the CORA4.1 data, c) the sea ice concentration (in %) for the Northern Hemisphere and d) the Southern hemisphere, e) the in situ temperatura profiles (in °C) and f) the in situ salinity profiles (in Psu).

Table 1. Estimated accuracy numbers calculated using RMSE errors from data assimilation statistics for different layers and three different periods for temperature (left column in °C) and salinity (right column in Psu). 2005 being the year where more than 2000 Argo profilers floated in the World Ocean.

	1993-2015		1993-2005		2005-2015	
	Temp (°C)	Salinity (Psu)	Temp (°C)	Salinity (Psu)	Temp (°C)	Salinity (Psu)
0-100m	0.78	0.21	0.87	0.25	0.68	0.16
100-300m	0.69	0.11	0.77	0.13	0.61	0.09
300-800m	0.43	0.06	0.49	0.07	0.36	0.05
800-2000m	0.18	0.03	0.24	0.04	0.12	0.02

Table 2. Estimated trends in GMSL and components between 1993 and 2015 for GLORYS2V4 and from Chambers et al. (2017). For Chambers et al. (2017), exact time-period is given; uncertainty is 90% confidence level. GIA is for Global Isostatic Adjustment.

TREND (MM/YR) [0M-BOTTOM]	GLORYS2V4 (1993-2015)	CHAMBERS ET AL. (2017) (1992-2014)
Total steric	1.6	1.2 ± 0.23
Thermo-steric	1.8	1.2 ± 0.23
Halo-steric	-0.2	~0
Total mass	1.74	1.8 ± 0.46 (1992-2013)
Sum of components	3.34	3.0 ± 0.52
GMSL (GIA corrected)	3.56	3.19 ± 0.63

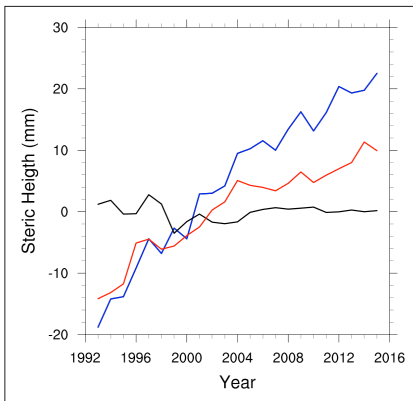

Fig. 2. Annual time series of the [60°S-60°N]/[0-700m] averaged Halo-steric (black) and thermo-steric (blue) signals from GLORYS2V4 and thermo-steric signal (red) from CORA4.1 data base (in mm). Linear trend for each time series are resp. 0., 1.78 and 1mm/yr.

References

- Ezraty R., F. Girard-Ardhuin, J. F. Piolle, L. Kaleschke and G. Heygster, 2007. Arctic and Antarctic sea ice concentration and Arctic sea ice drift estimated from Special Sensor Microwave data, *User's Manual, Version 2.1, CERSAT*.
- Balmaseda, M. A., Hernandez, F., Storto, A. & 45 co-authors, 2015. The Ocean Reanalyses Intercomparison Project (ORA-IP). *Journal of Operational Oceanography*, Volume 8 (S1), p. 10.
- Cabanes, C., A. Grouazel, K. von Schuckmann, M. Hamon, V. Turpin, C. Coatanoan, F. Paris, S. Guinehut, C. Boone, N. Ferry, C. de Boyer Montégut, T. Carval, G. Reverdin, S. Pouliquen, and P. Y. Le Traon, 2013: The CORA dataset: validation and diagnostics of *in situ* ocean temperature and salinity measurements. *Ocean Science*, 9, 1-18, <http://www.ocean-sci.net/9/1/2013/os-9-1-2013.html>, doi:10.5194/os-9-1-2013.
- Chambers, D. P., A. Cazenave, N. Champollion, H. Dieng, W. Llovel, R. Forsberg, K. von Schuckmann and Y. Wada, 2017. Evaluation of the global mean sea level budget between 1993 and 2014. *Surv. Geophys.*, Volume 38(1), pp. 309-327.
- Dai, A., Qian, T., Trenberth, K. & Milliman, J., 2009. Changes in Continental Freshwater Discharge from 1948 to 2004. *Journal of Climate*, Volume 22, pp. 2773-2792.
- Good, S. A., Martin, M. J. & Rayner, N. A., 2013. EN4: quality controlled ocean temperature and salinity profiles and monthly objective analyses with uncertainty estimates. *Journal of Geophysical Research - Oceans*, Volume 118, pp. 6704-6716.
- Levitus, S., J.I. Antonov, T.P. Boyer and C. Stephens, 1998. *World Ocean Database 1998 - NOAA Atlas NESDID18*. s.l.: National Oceanographic Data Center, Silver Spring, MD.
- Palmer, M. D., Roberts C.D. and 21 co-authors, 2017. Ocean heat content variability and change in an ensemble of ocean reanalyses. *Climate Dynamics*, 01 Aug, 49(3), pp. 909-930.
- von Schuckmann, K. & 79 co-authors, 2016. The Copernicus Marine Environment Monitoring Service Ocean State Report. *Journal of Operational Oceanography*, 9(doi: 10.1080/1755876X.2016.1273446, sup2), p. 235.
- Storto, A., S. Massina, M.A. Balmaseda & 34 co-authors, 2015. Steric sea level variability (1993-2010) in an ensemble of ocean reanalyses and objective analyse. *Clim. Dyn.*, p. 10.
- Tournadre, J., Bouhier, N., Girard-Ardhuin, F. & Remy, F., 2016. Antarctic icebergs distributions 1992-2014. *Journal of Geophysical Research: Oceans*, 121(1), pp. 327-349.

A NORTH SEA-BALTIC SEA REGIONAL COUPLED MODELS: ATMOSPHERE, WIND WAVES AND OCEAN

J. Staneva⁽¹⁾, C. Schrum⁽¹⁾, A. Behrens⁽¹⁾, S. Grayek⁽¹⁾, H. Ho-Hagemann⁽¹⁾,
V. Alari⁽²⁾, Ø. Breivik⁽³⁾ and J-R. Bidlot⁽⁴⁾

⁽¹⁾ Institute for Coastal Research, HZG, Geesthacht, Germany, e-mail: Joanna.Staneva@hzg.de

⁽²⁾ Marine Systems Institute, Tallinn University of Technology, Akadeemia tee 15a, 12611
Tallinn, Estonia

⁽³⁾ Norwegian Meteorological Institute and Geophysical Institute, University of Bergen, Norway

⁽⁴⁾ European Centre for Medium-Range Weather Forecasts (ECMWF), Shinfield Park, Reading
RG2 9AX, United Kingdom

Abstract

The coupling of models is a commonly used approach when addressing the complex interactions between different components of earth system. This study presents the development of a new, high -resolution, coupled atmosphere, ocean and wave model system for the North Sea and the Baltic Sea, which is part of the Geestacht COASTal model SysTEm GCOAST. We focus on the nonlinear feedback between strong tidal currents and wind -waves, which can no longer be ignored, in particular in the coastal zone where its role seems to be dominant. The proposed coupling parameterizations account for the feedback between of the upper ocean on the atmospheric circulation by accounting for the effects of sea surface temperature and the sea surface roughness. Several sensitivity experiments are performed to estimate the individual and collective effects of different coupling components. The performance of the coupled modelling system is illustrated for the cases of several extreme events. For example, the inclusion of wave coupling leads to decreases strong winds through wave dependent surface roughness or changes sea surface temperature, the mixing and ocean circulation; leading to better agreement with in -situ and satellite measurements. We demonstrate how the satellite altimeter observations can be used to support further the regional and coastal oceanography. The model comparisons with data from satellite altimeter and in situ observations showed that the use of the fully coupled system reduces the errors, especially under severe storm conditions. This justifies the further developments and implementation of the coupled model systems and its synergy with the newly available satellite observations, for both, operational and climate research and development activities.

Keywords: Coastal forecasting system, North Sea, Baltic Sea, coupled wave-circulation-atmosphere models

1. Introduction

Accurate coastal ocean forecasting remains a challenging topic in coastal flooding research, not least along the European shelf which is characterized by vast shallow tidal flats and a large coastal population. The increased demand for improved water level predictions requires further development and refinement of the physical processes represented by the hydrodynamical models to properly account for wave generated currents and the corresponding changes to the water level. The effect of coupling on model predictions becomes more important (Janssen *et al.*, 2004) with increasing the grid resolution, which therefore emphasizes the need for coupling on the regional scales. Spatial and temporal changes in the wave and wave energy propagation are not yet sufficiently addressed in high-resolution regional atmospheric models. The shallow water terms in the wave equations (depth and current refraction, bottom friction and wave breaking) play a dominant role near coastal areas, especially during storm events, where the wave breaking term prevents unrealistically high waves near the coast. The spray caused by breaking waves modulates the atmosphere boundary layer. Air-sea interaction is also of great importance in regional climate modelling. Understanding the wave-current interaction processes is important for the coupling between the ocean, atmosphere and waves in numerical models. Storm surges are meteorologically driven, typically by wind and atmospheric pressure. Waves combined with higher water levels may break dykes, cause flooding, destroy construction and erode coasts. Coastal flooding can be caused by the combined effects of wind waves, high tides and storm surges in response to fluctuations in local and remote winds and atmospheric pressure. The role of these processes can be assessed using high-resolution coupled models. However, in the frame of forecasting and climate modelling studies, the processes of wave and current interactions are not sufficiently exploited. We examine the effect of wave-current interaction in the North Sea and the Baltic Sea during the extremes with an example of storm Xaver (5-7 December 2013). We quantify the individual and collective role of the coupled processes and compare the model results with observational data.

2. Methods

2.1 Models used

The Circulation model NEMO (Nucleus for European Modelling of the Ocean, Madec *et al.*, 2008) is a framework of ocean related computing engines, from which we use the OPA package (for the ocean dynamics and thermodynamics) and the LIM2 sea-ice dynamics and thermodynamics package (Madec *et al.*, 2008). The wave model WAM (The WAMDI group, 1988; ECMWF, 2014) is a third-generation wave model, which solves the action balance equation without any a priori restriction on the evolution of spectrum. The last release of the third generation wave model WAM Cycle 4.5.4 is an update of the WAM Cycle 4 wave model, which is described in Komen *et al.*, (1994) and Günther *et al.*, (1992) and Staneva *et al.*, 2015. NEMO and WAM models share the same computational grid and bathymetry with horizontal resolution of 2 nautical miles covering the Baltic Sea and the North Sea (Fig. 1). The spectrum in WAM was discretised with 24 directions and 25 frequencies. The hourly atmospheric forcing is based on the German Weather Service (DWD) short range forecasts (24 hours) and we use bulk formulation in NEMO. The open boundaries of the model domains are located in west of English Channel and near the continental shelf break of the North Sea. The atmospheric model used in this study is the non-hydrostatic regional climate model COSMO-CLM (CCLM) version 4.8 (Wahe *et al.*, 2017, Rockel *et al.*, 2008). The atmospheric model used in this study is the non-hydrostatic regional climate model COSMO-CLM (CCLM) version 4.8. The model equations are formulated in rotated geographical coordinates with generalized terrain following vertical coordinates. In our setup, we use a spatial resolution of $\sim 10\text{km}$ and 40 vertical levels to discretize the area around the North Sea and Baltic Sea. Exchanged fields between the atmospheric CCLM and the wave model WAM are wind and sea surface roughness length and the models are coupled using the coupler OASIS3-MCT.

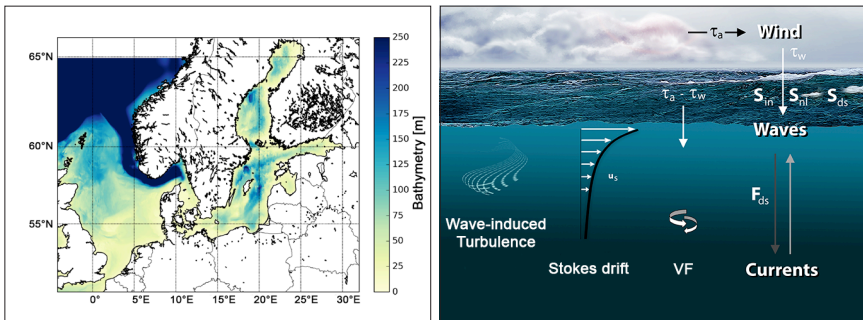

Fig. 1. Left: Model area; right: wave induced processes into NEMO.

2.2 Wave effects in the ocean model

Ocean waves influence the circulation through number of processes: turbulence due to breaking and non-breaking waves, momentum transfer from breaking waves to currents in deep and shallow water, wave interaction with planetary and local vorticity, Langmuir turbulence. The NEMO ocean model has been modified to take into account the following wave effects as described by Staneva *et al.*, (2017) and Alari *et al.*, (2016): (1) The Stokes-Coriolis forcing; (2) Sea state dependent momentum flux; and (3) Sea state dependent energy flux. A schematic overview of these processes is shown on Fig. 1.

3. Impact of coupling between the atmosphere and wave models

We aim at a quantification of the effects of coupling of wave and atmospheric models, also during extreme storm events (Wahle *et al.*, 2017). We compare simulations between coupled and stand-alone models that we validate with newly available space-based observational data. In the one-way coupled setup, the wind wave model only receives wind data from the atmospheric model. In the two-way coupled setup, the wind wave model sends the computed sea-surface roughness back to the atmospheric model. Our novel contribution here is that we simultaneously run (via a coupler) a regional North Sea coupled wave-atmosphere model together with a nested-grid high resolution (ca.1 km) in the German Bight wave model (one atmospheric model and two wind wave models). Using this configuration allows us to study the individual and combined effects of (1) model coupling one-way (1wc) versus 2-way (2wc) and (2) grid resolution, especially under severe storm conditions, which is a challenging aspect for wave modelling at the German Bight (GB) because it is a very shallow and dynamically complex coastal area. Fig. 2 illustrates the time variability of the significant wave height (top) and the wind speed (bottom) at the Helgoland stations from observations (black line) and the different model runs during the storm Xaver. The storm characteristics are matched well (Fig.2). Throughout this period, the highest values of significant wave heights are simulated by the WAM-NS-1wc experiment. The lowest values, and closest to the observations, are from the WAM-GB-2wc simulations. The wave heights predicted by the WAM-GB-2wc are in best agreement with the observations. The influence of spatial resolution on the simulated characteristics can be clearly seen in the time series at the deep water buoy at Helgoland. The importance of the two-way coupling is clearly demonstrated by comparing the WAM-GB-2wc (the blue line) and WAM-GB-1wc (the red line) in Fig. 2. The simulated significant wave height WAM-GB-2wc is reduced, especially during the Xaver peak, and is closer to the measurements.

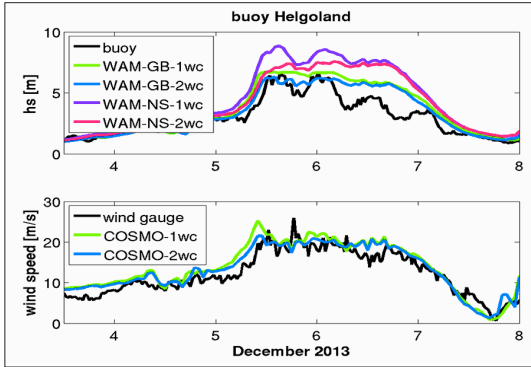

Fig. 2. Significant wave height (m, top) and wind speed (m/s, bottom) during the storm ‘Xaver’ at the buoys Helgoland.

4. Impact of circulation model on wave results

The wave spectra at Elbe buoy station are given in Fig. 3 for the study period. The wave spectra from the model simulations (Fig. 3b) are in a good agreement with the spectra from the observations (Fig. 3a). The time variability of the spectral energy is accurately reproduced by the model, and the energy around the peak is similar in the observations and simulations; however, the model patterns are smoother than the observed patterns in the wave model only compared to the coupled wave-circulation model (Staneva *et al.*, 2016).

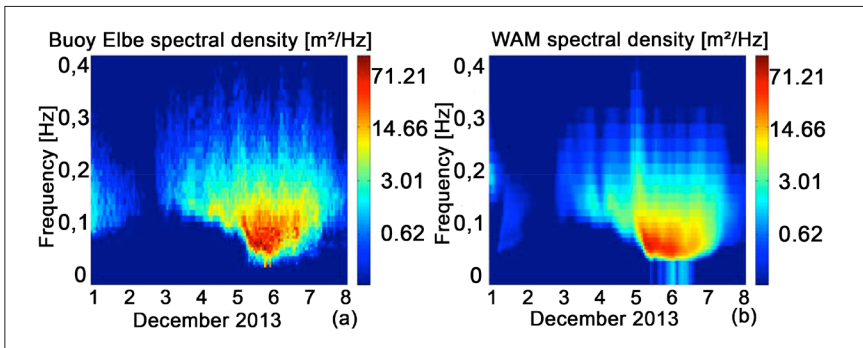

Fig. 3. Comparison of measured (left) and computed (right) values of the spectral energy density at the buoy Elbe.

5. Impact of wave-induced processes on the circulation model

5.1 Impact of waves on SST

We compare the sea surface temperature between the four scenarios in which the wave effects, described in Section 2, have been taken into consideration and the control simulation (CTRL). The aim is to distinguish which of the three mechanisms are dominant in changes of temperature for the different Baltic Sea areas (Alari *et al.*, 2016). We calculate the summer averaged (JJA) temperature difference between the four coupled- wave-circulation model runs and the control experiment (only NEMO run). When all the three wave processes are taken into account (Fig. 4a), in every Baltic Sea sub-basin, wave impact on the SST is noticeable. In order to better understand the processes responsible behind this pattern we also plot the differences when each wave process is taken into consideration independently (Fig. 4b,c,d). In the simulations, wave breaking has mostly a warming effect (Fig. 4b), especially in northern areas of the Baltic Sea. This suggests that Stokes-Coriolis forcing mainly contributes during cases when the conditions are favourable for upwelling. The most “large scale” differences are induced by taking into account wave dependent momentum flux (Fig. 4d) and the effect is mostly in warming the surface water. By taking into account wave dependent momentum flux we indirectly modify the heat exchange at the ocean-air boundary, since turbulent fluxes depend on the stress which is felt by ocean. Directly the wave dependent momentum flux affects the currents and therefore the advection of water, which can result in redistribution of cooler/warmer water.

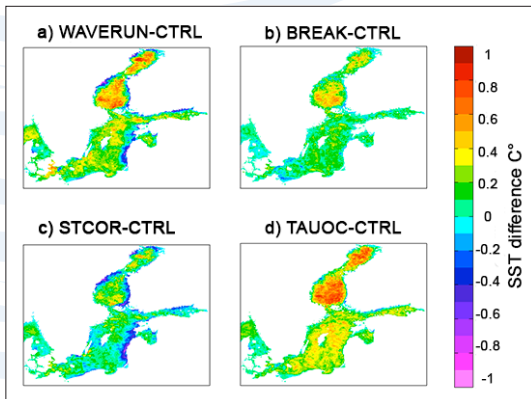

Fig. 4. Sea surface temperature differences between ALLWAVE and CTRL averaged over a 3-month period, from 01 June 2013 to 31 August 2013.

5.2 Impact of waves on Sea level

We found improved skill in the predicted sea level and circulation during storm conditions when using a wave-forced circulation model system (Staneva *et al.*, 2017). In the periods of storm events, the ocean stress was significantly enhanced by the wind-wave interaction leading to an increase in the estimated storm surge (compared to the ocean-only integration) to values closer to the observed water level. The numerical experiment with the coupled wave-circulation model yielded an increase of 48cm in and surge level in the south-eastern shallow North Sea and along the North-Frisian Wadden Sea coast for the Xaver event (Fig. 5).

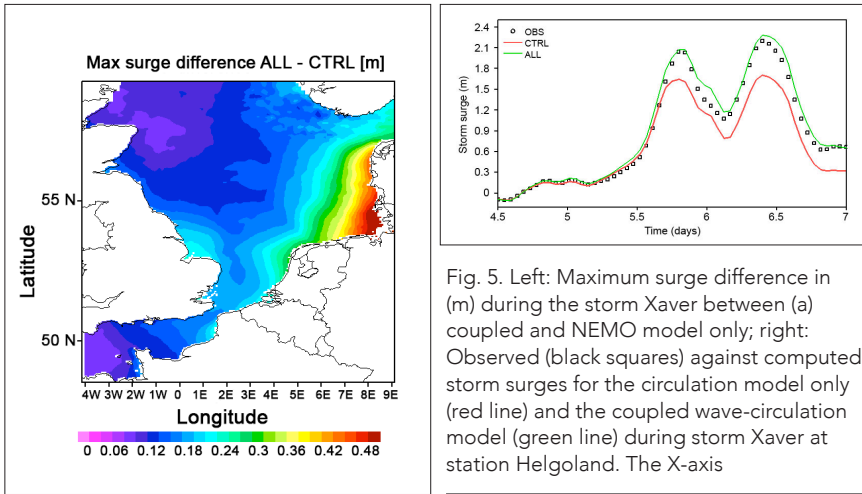

Fig. 5. Left: Maximum surge difference in (m) during the storm Xaver between (a) coupled and NEMO model only; right: Observed (black squares) against computed storm surges for the circulation model only (red line) and the coupled wave-circulation model (green line) during storm Xaver at station Helgoland. The X-axis

6. Conclusions

We found improved skill in the predicted sea level and circulation during storm conditions when using a coupled wave-circulation model. In the periods of storm events, the ocean stress was significantly enhanced by the wind-wave interaction leading to an increase in the estimated storm surge (compared to the ocean-only integration) to values closer to the observed water level. The numerical experiment with the wave-forced NEMO model yielded an increase of 48cm in and surge level in the south-eastern shallow North Sea and along the North-Frisian Wadden Sea coast for the Xaver event. We show that the coupling between atmosphere and wave models led to improvement of model predictions. The model comparisons with data from satellite altimeter and *in situ* observations showed that the use of the fully coupled system reduces the errors, especially under severe storm conditions. This justifies the further developments and implementation of the coupled model systems and its synergy with the newly available satellite observations, for both, operational and climate research and development activities.

Acknowledgements

This publication has received funding from the European Union's H2020 Grant Agreement N°: H2020-EO-2016-730030-CEASELESS. Parts of this work were supported by CMEMS COPERNICUS Grant WAVE2NEMO.

References

- Alari V., Staneva J., Breivik O., Bidlot J.R., Mogensen K. and Janssen PAEM (2016). Response of water temperature to surface wave effects in the Baltic Sea: simulations with the coupled NEMO-WAM model. *Ocean Dynamics*, DOI 10.1007/s10236-016-0963-x
- Breivik, O., J-R. Bidlot, P.A. Janssen (2016). A Stokes drift approximation based on the Phillips spectrum, *Ocean Modelling*, 100, pp 49-56, doi:10.1016/j.ocemod.2016.01.005
- Janssen, PAEM, Breivik, O., Mogensen, K., Vitart, F., Balmaseda, M., Bidlot, J-R., Keeley, S., Leutbecher, M., Magnusson, L., Molteni, F., (2013) Air-sea interaction and surface waves, ECMWF, *Technical Memorandum*. 712, 34 pp
- Kourafalou V., De Mey P., Staneva J., Ayoub N., Barth A., Chao Y., M Cirano M., et al., 2015. Coastal Ocean Forecasting: science foundation and user benefits, *Journal of Operational Oceanography* 8, 147.
- Madec G., (2008) NEMO ocean engine. Note du Pole de modelisation. Institut Pierre-Simon Laplace (IPSL), France, No 27, ISSN No 1288-1619, 217 pp
- Rockel, B., Will, A., and Hense, A. (2008) The Regional Climate Model COSMO-CLM (CCLM). *Meteorol. Z.*, 17, 347-348.
- Stanev E., Schulz-Stellenfleth J., Staneva J., Grayek S, Grashorn S., Behrens A, Koch W., and Pein J. (2016). Ocean forecasting for the German Bight: from regional to coastal scales, *Ocean Sci.*, 12, 1105-1136, 2016, doi:10.5194/os-12-1105-2016.
- Staneva, J., A. Behrens and Wahle K., 2015. Wave modelling for the German Bight coastal-ocean predicting system, *Journal of Physics: Conference Series*, 633, pp 233-254, doi:1211, 0.1088/1742-6596/633/1/012117, ISBN: 978-3-939230-28-1.
- Staneva J., Alari V., Breivik O, Bidlot J.-R. and Mogensen K., (2016). Effects of wave-induced forcing on a circulation model of the North Sea. *Ocean Dynamics*, DOI 10.1007/s10236-016-1009-0
- Staneva J., Wahle K. Günther H. and Stanev E., 2016. Coupling of wave and circulation models in coastal-ocean predicting systems: A case study for the German Bight, *MS N°.: OS-2015-86*, Special Issue: Operational oceanography in Europe 2014 in support of blue and green growth, 12, 3169-3197.
- Staneva J., Wahle K., Koch W., Behrens A., Fenoglio-Marc L., and Stanev E., (2016).

Coastal flooding: impact of waves on storm surge during extremes – a case study for the German Bight, *Nat. Hazards Earth Syst. Sci.*, 16, 2373-2389, doi:10.5194/nhess-16-2373-2016.

Wahle K., Staneva J, Koch W., Fenoglio-Marc L., Ho-Hagemann H., and Stanev E. , (2016). An atmosphere-wave regional coupled model: improving predictions of wave heights and surface winds in the Southern North Sea. *Ocean Sci. Discuss.*, doi:10.5194/os-2016-51, 2016.

TOWARDS SEAMLESS OCEAN MODELLING FOR THE BALTIC SEA

J. She ⁽¹⁾ and J. Murawski ⁽¹⁾

⁽¹⁾ Danish Meteorological Institute, Lyngbyvej 100, DK-2100 Copenhagen Denmark. js@dmi.dk

Abstract

Seamless approaches to ocean modelling have been developed in the recent years to follow the user needs from the first generation of basin scale wide operational storm surge prediction systems to local, high-resolution model applications for ocean waves-currents and bio-geochemical parameters. They have successfully conquered the basin and the near-coastal scales, but they have to evolve further, to cover the large scales in the required high resolution necessary to serve decision support systems. To serve as a high quality seamless prediction system, an ocean model has to fulfil certain requirements on model physics, grid configuration, code's computational standard and efficiency and also the coupling interface with other system components. The purpose of this paper is to illustrate these requirements and gaps between a state-of-the-art ocean model and the seamless modelling approach. In this context, a widely used Baltic Sea operational ocean model, HBM, is evaluated, as an example, against the requirements for seamless ocean modelling. Future research towards a seamless ocean modelling in the Baltic Sea is also identified.

Keywords: seamless ocean model, model resolution, high performance computing, Baltic Sea

1. Introduction

An important feature for future European sea operational ocean models will be its capacity on seamless modelling. WMO (2015) proposed future forecasting system framework "Seamless prediction of the earth system: from minutes to months". The initial implementation plan mainly focuses on atmospheric modelling from global to convective scales. Although ocean-wave-ice system is mentioned as an integrated part of the earth system, a roadmap to a seamless prediction of the ocean-wave-ice system has not been made yet. The seamless ocean forecasting was further identified as a research priority in the EuroGOOS scientific strategy paper (She *et al.*, 2016): the ocean models should be developed to effectively simulate both open ocean and coastal-estuary waters as well as short and long temporal scales. The final goal is to

develop pan-European Sea ocean models with seamless modelling and prediction capacity. Such models must describe the dynamics of the coupled ocean-wave-ice-ecological-system on all required temporal and spatial scales. It must be supported by a computational efficient model engine (memory use, multi- and many-core architectures etc.), to run large scale set-ups in high resolution. It must also have variable grid structures (curvilinear, unstructured) or dynamical two-way nesting, to set-up complex model systems that can bridge the gap efficiently between the large scales (required for generating boundary conditions) and the local scales required for high-resolution applications. It also needs an I/O (Input/Output) server or other facilities to handle time-consuming and memory intensive input and output efficiently. Here we follow an integrative approach to seamless modelling, which builds on successful model components for the atmosphere, ocean and land, and focus in the following only on the ocean component.

Although basin-scale operational ocean models have been used in climate modelling such as regional reanalysis and projections (Fu *et al.*, 2012; Tian *et al.*, 2013), there are still many unresolved issues towards a full seamless prediction, such as sufficiently high resolution, coupling and high performance computing etc. High resolution is needed in ocean models in order to resolve complex bathymetry and coastlines, e.g. narrow straits and sills in hundreds to thousands of meter width which connect the European sea basins and sub-basins, and also important small scale processes, e.g. mesoscale and submesoscale eddies and coast-estuary interaction etc. The former plays a key role in the ocean models in order to simulate correctly the inter-basin and intra-basin water transport (She *et al.*, 2007) while the latter are important in water mass and nutrient transport (e.g. Shcherbina *et al.*, 2015; Swart *et al.*, 2015). In certain parts of spatiotemporal spectrum scales, like climate scale or coastal-estuary scale, the coupling between ocean and other earth system components, like atmosphere, waves and hydrology, becomes rather important. Hence a full seamless prediction can only be reached in an integrated earth system modelling framework. To realize both the sufficient resolution and fully coupled model systems, efficient high-performance computing is needed (Poulsen *et al.*, 2014). Through code modernisation, model codes will reach industrial standard and be able to exploit compatible hardware potentials on new supercomputing architectures (e.g. many-core processors, increased number of Instruction Set Architectures - ISA etc.).

The existing European operational ocean modelling, in its development, has not been deliberately designed in a seamless modelling framework, although many relevant components have already been made. It is necessary to review the state-of-the-art of the operational ocean modelling in the context of seamless modelling, so that the gaps and necessary integration of different modelling components can be identified. The purpose of this paper is to use a widely used operational ocean model, the HIROMB-BOOS Model (HBM), as an example, to review the frontier of the operational modelling in the Baltic Sea and to identify the gaps for seamless modelling. Section 2

summarises the Baltic user needs on ocean models and reviews the state-of-the-art of existing operational ocean forecasting systems. Section 3 presents some recent operational modelling progresses in related to seamless prediction. Conclusions are given in section 4.

2. Operational ocean models: user needs and current status

Current operational model systems in the Baltic Sea include both basin-scale systems and local systems for national sea waters, fjords and lakes. The basin-scale operational ocean model systems are supposed to provide the past, present and future ocean physical state for regional users like HELCOM (Helsinki Commission for Baltic Marine Environment Protection Commission); EU agencies for implanting policies on environment, fishery or climate change adaptation ; and for modelling users who need basin-scale model products as boundary forcing for their numerical ocean, weather, climate models or biogeochemical models. The local forecasting systems mainly provide coastal services with higher resolution serving the national user communities, in both public and commercial sectors. Table 1 gives a summary of current operational forecasting systems used in the Baltic Sea.

Table 1. Basin and local forecasting systems in the Baltic Sea

PRODUCTION UNIT	BASIN SYSTEM		LOCAL SYSTEM		
	MODELS	RESOLUTION	MODEL	RESOLUTION	AREA
BAL MFC	HBM	1.85km			
BSH (GE)	HBM	1.85km	HBM	0.93km	Transition waters
DMI (DK)	HBM	5.55km	HBM	0.4km	Limfjoden
			HBM	0.93km	Transition waters
FMI (FI)	OAAS (2D)	3.7km	HELMI (sea ice)	1.85km	Northern Baltic Sea
	HBM	5.55km			
MSI (EE)			HBM	0.93km	Gulf of Finland, Gulf of Riga
SMHI (SE)	NEMO-Nordic	1.85km	NEMO	0.36km	Lake Vänern
			NEMO	0.06km	Brofjorden
UL (LV)			HBM	10 ² m-1.85km	Eastern Baltic Sea, lakes

The configuration of operational ocean models relies not only on the ocean dynamics but also on the user requirements. Different user groups normally have different resolution and quality requirements. The water level (both mean sea level and extremes) forecast quality is essential for storm surge warning, integrated coastal zone management, coastal flooding or shipping. For ecosystem-based management, summer sea surface temperature is critical to the formation of cyanobacteria bloom; the water temperature is important for prediction of hypoxia conditions. In addition, the water exchange between the Baltic and North Sea, the sub-basins and the coastal-estuary continuum has significant impacts on the deep layer Baltic Sea biogeochemical conditions. Therefore for long-term ecosystem modelling, specification of the right water stratification, mixing and also the mass transport is important. For the blue growth sectors, requirements to ocean models are more limited to marine operation areas, which can be either basin or more local scales. Forecasts of extreme sea levels in ports and very shallow areas are important for the navigation; fronts and eddies location can be of interests to fishery and aquaculture; bottom currents play important role in sediment transportation which are essential for undersea cables and construction of offshore wind farms. An ocean model with seamless modelling capacity is expected to meet all the above requirements posed by the end users, namely, i) being able accurately resolve mass transport between estuary, coastal water, sub-basins and between the Baltic-North Sea; ii) having proper stratification, vertical mixing rate, and no major drift in temperature and salinity; iii) being able to simulate water transport made by mesoscale and submesoscale eddies, either through parameterization or explicit modelling; iv) high quality sea level in entire Baltic Sea, both mean sea level change and extremes.

As shown in Table 1, the state-of-the-art basin-scale forecasting systems in the Baltic Sea are represented by the CMEMS BAL MFC system and national operational forecasting systems. The models used in producing these forecasts are either HBM (Berg and Weismann, 2012) or NEMO-Nordic (Hordoir *et al.*, 2015) which builds upon the model framework Nucleus for European Modelling of the Ocean (NEMO). Here we apply a more in-depth analysis on the HBM to identify the gaps on resolution, computational efficiency and model quality for the seamless modelling.

Model resolution: HBM is a coupled ocean-ice model with a dynamic two-way nesting facility. It has been used both in forecasts up to a few hundreds of meters (Tab. 1) and basin-scale climate simulations such as reanalysis (Fu *et al.*, 2012), hindcast (Tian *et al.* 2013) and projections (Tian *et al.*, 2016). This means HBM is suitable for seamless modelling in terms of model resolution.

Computational efficiency: HBM has gone through a code modernization in the past years, aiming at being adapted to the newest supercomputing architecture based many core processors (Poulsen *et al.*, 2014). The array configuration has been optimized

for memory usage and ISAs such as Single Instruction Multiple Data. Efficient hybrid parallel computing is enabled. The binary identical code has been tested on Xeon-Phi processors showing excellent node balance. The dynamic two-way nesting function allows flexible grids in focused areas.

Efficient handling of model Output: HBM has been advanced with an I/O server, using a dedicated task for the gathering of the model state and the writing out of the gathered model fields.

Model quality:

Water level: HBM is used as storm surge model in Germany, Denmark, Estonia and Latvia. It has been proved an excellent model for water level and storm surge forecast (Golbeck *et al.*, 2017). According to a model intercomparison study, the mean centralized Root Mean Square Error (cRMSE) of water level hindcast from HBM (Version 3 in BAL MFC, using a setup in Table 1) at 62 Baltic Sea tidal gauge stations is 7.6cm for a four year validation period 1 June 2011 – 31 May 2015.

Vertical mixing and stratification: HBM can reproduce the vertical stratification reasonably well on synoptic to seasonal scales (Golbeck *et al.*, 2017). However, the rate of stagnation of deep water in HBM is faster than observed. Fu *et al.*, (2012) showed that in a 20-year hindcast run from a coarse resolution HBM, a negative bias of 2psu is found for the deep layer salinity in the Gotland Deep. This delivers a message that the bottom slope flow may not be well resolved by HBM especially in areas with steep topography.

Sea ice: Validation reports from CMEMS show that the ocean surface layer in the Northern Baltic Sea is cooling down too fast and is producing thin layers of sea ice with rather high ice concentrations during the ice forming seasons and is reducing the sea ice coverage to fast during the melting season (Golbeck *et al.*, 2017). HBM recently added a fast ice module accounting for the formation, consolidation and disintegration of fast ice, and the advance and retreat of its front.

Mesoscale and submesoscale eddies: Baltic Sea is an active area with submesoscale eddies with diameter of 1-15km (Karimova and Gade, 2016). The 1.8km resolution may not be sufficient to resolve major part of the submesoscale eddies. Preliminary validation of HBM against measured currents shows that HBM is able to predict rather accurately the currents in the Danish Straits and storm generated currents at Arkona and HuvudskarOst stations. However, the model mean current speed is consistently lower than the observations at all levels at the Arkona and HuvudskarOst stations (figures not shown). One possible reason may be due to poorly resolving the energetic small scale currents by HBM.

3. Recent progresses towards seamless modelling

From the above analysis one may conclude that HBM is a good candidate for seamless modelling in the Baltic Sea. However, there exist a few major challenges to become a high quality seamless ocean model. Further improvements are needed in HBM's presentation on the sea ice, slope flow, deep layer salinity, small scale motions and coupling processes. Recently a few relevant progresses in HBM have been made along these directions.

Improvements in BAL MFC forecasting system V4: improved ice thermodynamics is implemented in HBM ice module. The sea ice concentration and volume from the model are improved both in ice formation and melting seasons. More information on HBM V4 features can be found in a CMEMS BAL MFC presentation in this book (Tuomi et al. 2017).

Coupling between storm surge model and inundation model for coastal flooding prediction: in Danish project VASKO, DMI storm surge model HBM is coupled with a DHI inundation model in the catchment of Roskilde. This pre-operational setup will be able to provide coastal flooding forecast and a risk estimation for the household by coming house insurance information for the Roskilde region (personnel communication with K.S. Madsen, 2017).

Bridging the gaps from basin scale-to-coastal-estuary-and fjord applications: a pre-operational setup of two-way nested Baltic-Limfjorden-North Sea model with horizontal resolution of 185 meters in Limfjorden has been implemented at DMI. The system can be used for both storm surge forecast and ecosystem study in the Limfjorden area. Results showed that the high resolution in the model improves the water level prediction in the storm surge cases.

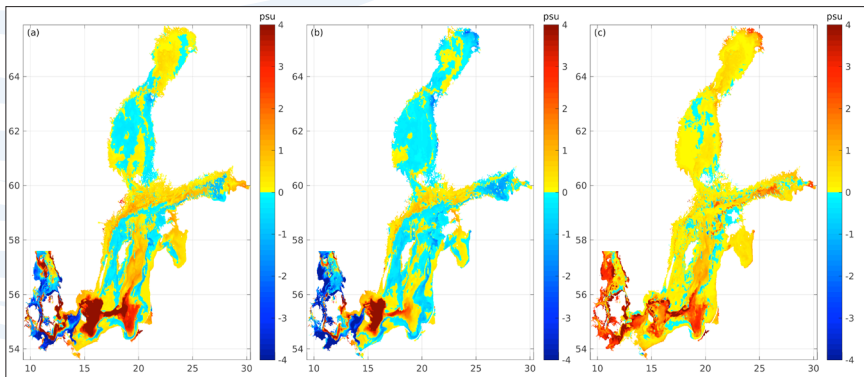

Fig. 1. Impact of model resolution on the Baltic inflow - bottom salinity difference between (a) 15 November 2014 and 15 May 2015 in the 0.93km resolution HBM; (b) 15 November 2014 and 15 May 2015 in the 1.85km resolution HBM and (c) the 0.93km resolution HBM and 1.85km resolution HBM in 15 May 2015.

High resolution Baltic Sea model: HBM's abilities for seamless modelling have been further tested by developing a 0.93km horizontal resolution set-up for the Baltic Sea and the Transition Zone to the North Sea, the setup requires less than 7 minutes time per day when 480 cores are employed. A model run is made for the period 1 October 2014 – 31 Dec. 2015 which covers 2014/15 Major Baltic Sea Inflow (MBI) event. The high salinity water flows into the Baltic Sea since 3 December 2014. The intra-basin transport of saline bottom water lasts for several months and reaches Baltic Proper (Neumann *et al.*, 2017). One purpose of this study was to improve HBM performance in simulating the deep layer salinity and MBI. The high resolution results are analysed and compared with results from a preliminary version of BAL MFC V4 which has a horizontal resolution of 1.85km. Fig. 1a-1c shows the bottom salinity change before (15 November 2014) and after (15 May 2015) the MBI event in the 0.93km resolution model, the 1.85km resolution model and the bottom salinity difference between the two products in 15 May 2015, respectively. Fig. 1b suggests that the 1.85km resolution model can only resolve high salinity inflow in the western Baltic Sea. The inflow signal in most part of the deep central Baltic Sea is missing. The 0.93km model, however, simulated successfully the inflow up to the Northern Baltic Proper (Fig. 1a). The bottom salinity difference map between the two setups in 15 May (Fig. 1c) shows that the 0.93km model generates higher bottom salinity in most of the Baltic Sea than the 1.85km model. The difference is larger in the western part of the basin.

4. Conclusions

Developing seamless ocean modelling capacity has been identified as one of the main research priorities in European operational oceanography. This paper reviewed the capacity and gaps of a widely used operational ocean model (HBM) for the seamless modelling. User requirements and the adequacy of HBM to fit-for-purpose are evaluated. It is shown that the model has been applied in applications covering wide range of spatiotemporal scales, from hundreds of meters to basin scales and from hours to centuries. The model has high quality in storm surge forecast and climate modelling, as well as flexible tow-way nesting facility and optimized code for efficient high performance computing on multi-core and many-core architectures. The use of high spatial resolution in the southern Baltic Sea has shown to improve slope flow and the deep layer salinity formation. It has also proven to be beneficial for the small-scale dynamics and the eddy formation (not shown). However, these features and also a better representation of the thermodynamics and dynamics of sea ice in the model requires further improvement.

Recent progresses on HBM are reported, e.g., improved ice forecast, coupling between HBM and inundation model for coastal flooding forecast, bridging the basin-coast-estuary areas with HBM's two-way nesting capacity and higher resolution (0.93km) HBM for the Baltic Sea. It is found that the 0.93km HBM significantly improved the salinity inflow and bottom salinity in most part of the Baltic Sea. The potential improvements of the high resolution HBM on resolving the submesoscale eddies and drift of bottom salinity are expected but needs yet to be further investigated.

Acknowledgements

The research leading to these results has received funding from the EfficienSea2 project of the European Union's Horizon2020 Programme project ID 636329.

References

- Berg, P., and Weismann Poulsen, J. (2012). Implementation details for HBM. DMI Technical Report No. 12-11. Copenhagen, 149 pp. (Available at: www.dmi.dk/fileadmin/Rapporter/TR/tr12-11.pdf).
- Fu W., She J., and Dobrynin M., 2012. A 20-yr reanalysis Experiment in the Baltic Sea Using three Dimensional Variational (3DVAR) method. *Ocean Sci.*, 8, 827-844.
- Golbeck I., Izotova J., Jandt S., Janssen F., Lagemaa P., Brüning T., Huess V., Hartman A. 2017. Quality Information Document (QUID) Baltic Sea Physical Analysis and Forecasting Product BALTICSEA_ANALYSIS_FORECAST_PHY_003_006: issue 4.0 <http://marine.copernicus.eu/documents/QUID/CMEMS-BAL-QUID-003-006.pdf>
- Hordoir R., Axell L., Löptien U., Dietze H. & Kuznetsov I. 2015. Influence of sea level rise on the dynamics of salt inflows in the baltic sea. *Journal of Geophysical Research: Oceans* 120: 6653–6668
- Karimova S., and Gade M., 2016. Improved statistics of sub-mesoscale eddies in the Baltic Sea retrieved from SAR imagery. *Int. J. of Remote Sensing*, 37(10), 2394-2414.
- Neumann, T., H. Radtke, and T. Seifert, 2017. On the importance of Major Baltic Inflows for oxygenation of the central Baltic Sea, *J. Geophys. Res. Oceans*, 122, 1090–1101, doi:10.1002/2016JC012525.
- Poulsen, J. W., Berg, P., and Raman, K.: Better Concurrency and SIMD On The HIROMB-BOOS-MODEL (HBM) 3D Ocean Code, in: High Performance Parallelism Pearls: Multicore and Many-core Programming Approaches, edited by: Jeffers, J. and Reinders, J., Morgan Kaufmann Publishing, USA, 2014.
- She J., Berg P. and Berg J., 2007. Bathymetry impacts on water exchange modelling through the Danish Straits. *J. Mar. Sys.* 65, 450-459.
- She J., Allen I., Buch E., Crise A., Johannessen J.A., Le Traon P.-Y., Lips U., Nolan G., Pinardi N., Reißmann J.H., Siddorn J., Stanev E. and Wehde H.: Developing European operational oceanography for Blue Growth, climate change adaptation and mitigation, and ecosystem-based management. *Ocean Sci.* 07/2016; 12(4). DOI:10.5194/os-12-953-2016
- Shcherbina, A.Y., Sundermeyer, M. A., Kunze, E., D'Asaro, E., Badin, G., Birch, D., Brunner-Suzuki, A.-M.E., G., Callies, J., Cervantes, B. T. K., Claret, M., 2015. The LatMix Summer Campaign: Submesoscale Stirring in the Upper Ocean. *Bulletin of the American Meteorological Society*, 96, doi: 10.1175/BAMS-D-14-00015.1.
- Swart, S., Thomalla, S. J., Monteiro, P. M. S., 2015. 615 The seasonal cycle of mixed

layer dynamics and phytoplankton biomass in the Sub-Antarctic Zone: A high-resolution glider experiment. *J. Mar. Syst.* 147, 103–115, doi: 10.1016/j.jmarsys.2014.06.002.

Tian T., Boberg F., Christensen O.B., Christensen J.H., She J. and Vihma T., 2013. Resolved complex coastlines and land-sea contrasts in a high-resolution regional climate model: a comparative study using prescribed and modelled SSTs. *Tellus A* 2013, 65, 19951, <http://dx.doi.org/10.3402/tellusa.v65i0.19951>

Tian T., Su T., Boberg F., Yang S. and Schmith T., 2016. Estimating uncertainty caused by ocean heat transport to the North Sea: experiments downscaling EC-Earth. *Climate Dynamics* 46 (1-2), 99-110

Tuomi L., She J., Lorkowski I., Axell L., Lagemaa P., Schwichtenberg F. and Huess V., 2017. Overview of CMEMS BAL MFC Service and Developments. *Proceedings of the 8th EuroGOOS Conference*, submitted.

World Meteorological Organisation (WMO), 2015. Seamless prediction of the Earth system: from minutes to months. https://library.wmo.int/opac/doc_num.php?explnum_id=3546

A TWO WAY NESTED HIGH RESOLUTION COASTAL SIMULATION IN A TIDALLY DOMINATED AREA: PRELIMINARY RESULTS

I. Mamoutos⁽¹⁾, T. Dabrowski⁽¹⁾, K. Lyons⁽¹⁾ and G. McCoy⁽²⁾

⁽¹⁾ Marine Institute, Rinville, Oranmore, Co. Galway, Ireland. ioannis.mamoutos@marine.ie

⁽²⁾ Bord Iascaigh Mhara, Crofron Road, Dun Laoghaire, Co. Dublin, Ireland

Abstract

Many coastal waterbodies along the Irish coast are tidally dominated. Kenmare Bay, in the southwest part, is a typical example. Physical and biogeochemical processes are controlled almost exclusively by the tides. In this paper preliminary results from a fully 3D high resolution numerical simulation using state of the art modelling methods are presented. In particular a two way nesting algorithm combined with a wetting and drying scheme is used to examine the impact of tides on an even smaller bay, namely Kilmakiloge Harbour. This bay is located along the southern shores of Kenmare Bay and is of high economic importance due to intense aquaculture activity therein. To date, only the hydrodynamic component of the model was activated and the results are compared with observations to assess the model skill.

Keywords: Kenmare Bay, coastal modelling, two way nesting, tidal mixing

1. Introduction

The tidal range over the Celtic Seas region is considered to be one of the largest in the European shelf. The tidal waves of open Atlantic are generally small but they increase as they move eastwards across to the Irish shelf and are enhanced dramatically by the funnelling effect of bays and estuaries. Kenmare Bay, at the southwest coast Ireland, is a typical example with an average tidal range of around 2 meters. Almost all physical and biogeochemical processes are mainly controlled by the tides and in smaller scale by the rivers outflow.

In this work we have set up a fully two-way nested 3D hydrodynamic simulation to focus on an even smaller bay (Kilmakilloge) inside the Kenmare and to investigate the impact of tides in it. Kilmakilloge is an economically important region due to intensive aquaculture activity. At the current stage only the hydrodynamic component of model is activated and the output data is under validation, but in the near future a set-up of a fully coupled physical – biogeochemical – shellfish model is planned.

2. Material and methods

2.1 Hydrographic observations

The hydrographic observations presented in this paper were obtained by Ireland's Seafood Development Agency (BIM) in the framework of monitoring the Kilmakilloge Harbour, through the installation of three loggers located in stations A, B and C (Fig. 1b). Data from these sites covers the period from February 15th 2017 to 4th of April 2017 and surpass the period of our initial hindcast for a few days. Loggers were set to record salinity and *in situ* temperature every one hour at 1 meter depth for all three stations, 4 meter at station A and 6.5 meters at station B. Unfortunately no data was recovered from the bottom station (6.5 meters) C due to logger fault.

2.2 Model description

The numerical simulation was performed using the Regional Ocean Modelling System (ROMS) (Shchepetkin and McWilliams, 2003, 2005), a free-surface, terrain-following, primitive equations ocean model widely used by the scientific community for a diverse range of applications (Haidvogel *et al.*, 2000; Wilkin *et al.*, 2005). A rectangular grid covering the Kenmare Bay with 120 meters resolution was developed (Fig. 1a) and a second one with 40 meters resolution for Kilmakilloge hereafter named the donor and the receiver grid respectively. The vertical resolution for both grids is 15 sigma levels. High resolution bathymetric data was provided by the INFOMAR Programme (www.infomar.ie), Ireland's Integrated Mapping for the Sustainable Development of Ireland's Marine Resource. A minimal smooth over the bathymetry was conducted using a linear programming method (Sikiric *et al.*, 2009).

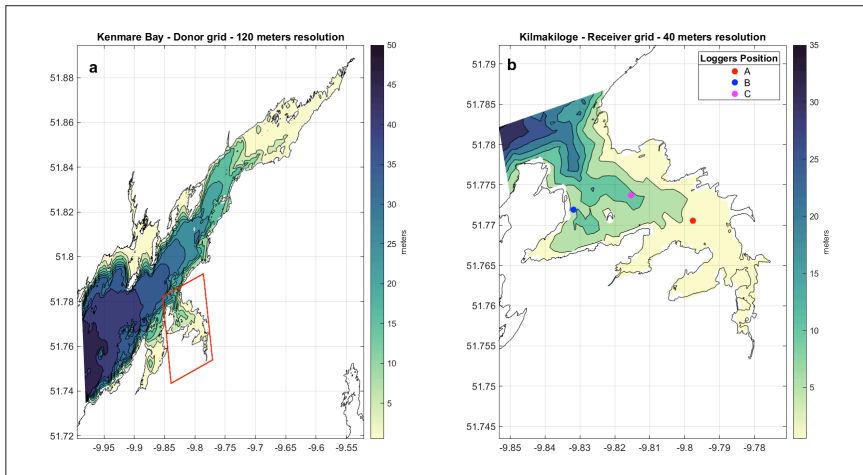

Fig. 1 . (a) Bathymetry in meters of Kenmare Bay and contact points of the receiver grid (red). (b) Kilmakiloge harbour's bathymetry in meters and the position of the temperature and salinity loggers.

From the available turbulence mixing schemes we adopted $k - \epsilon$ parameterization, as implemented through the GLS scheme (Umlauf and Burchard, 2003; Warner *et al.*, 2005). The model's default background values were used for vertical viscosity and diffusivity. For the horizontal diffusion and viscosity a harmonic Laplacian operator was selected with very weak value for stability reasons. A logarithmic drag law was used for the parameterization of bottom stress. The default third - order upstream advection scheme was used for velocity, TS_MPDATA (Smolarkiewicz, 1998) was used for the horizontal and vertical advection of tracers and a wetting and drying cell option. The initial and boundary conditions are provided from Marine's Institute high resolution coastal operational model of Bantry Bay (Dabrowski *et al.*, 2016). The boundary condition temporal resolution is 10 minutes and includes the tidal signal. Atmospheric forcing fields from ECMWF were used with spatial resolution 0.125×0.125 degrees and three-hour time step. Four major rivers are included and come from E-HYPE (SMHI - Swedish Meteorological and Hydrological Institute) and OPW (Office of Public Works, Ireland). The model was run from 8th of February to 26th of March 2017.

3. Results

The correlation coefficient, standard deviation and centred root mean square differences for *in situ* temperature of the water at the three BIM stations – for 1, 4 and 6.5 meters – are presented on Taylor diagrams in Fig. 2. Fig. 2 presents the comparison, in terms of statistics, between the observed and simulated values of *in situ* temperature at 1m depth – left panel – and for 4 and 6.5m depth – right panel – for all BIM stations inside Kilmakilloge Harbour.

Overall the model presents good skill and a correlation coefficient for temperature is close 0.8 for all stations and depths. As regards salinity (not shown here), the model's skill is significantly worse with correlation coefficient values close to zero and having positive and negative signs. It is worth noting thought that, especially for salinity the further we move from river mouth the better the score we obtain.

Not having any tidal records for Kilmakilloge Harbour we decided to use a coherence diagram to validate our model in terms of tides. Fig.3 (a) presents a coherence diagram and (b) the phase difference in degrees between observed and simulated data in order to investigate the ability of our model to reproduce the tidal signal correctly. The recorded and simulated salinity is shown for station B. The results for the other stations are similar. From the below figure we conclude that the model is able to represent in an adequate way the dominant tidal harmonics, the semi-diurnal and the shallow water quarter diurnal, having high coherence scores for both (0.8) for 99% confidence level. The phase difference for the semi-diurnal constituent is close to zero and for the shallow water quarter diurnal almost 45 degrees.

4. Conclusions/Discussion

In this work we present the preliminary results from a high resolution two way nested simulation for Kenmare Bay and Kilmakilloge Harbour for assessing the model behaviour, exploiting the observed hydrographic data as a benchmark for our future hindcasts which will include a fully coupled physical – biogeochemical – shellfish setup. Our preliminary results suggest that the model reproduces the dominant mechanism – tidal mixing – in an adequate way (Fig. 3) for the area of interest and also that there is a good match – especially for temperature – between the observed and simulated data. One possible source for the difference in shallow water quarter semi-diurnal constituent between model and observation can be the use of the default value for model's bottom drag coefficient.

The lack of realistic data for the rivers outflow inside Kilmakilloge Harbour is a significant source of errors and is aliasing for simulated temperature and salinity fields. From our analysis it is clear that the main problem is the riverine outflow and that the closer we move to the river mouth the lower the value and skill scores we obtain for the

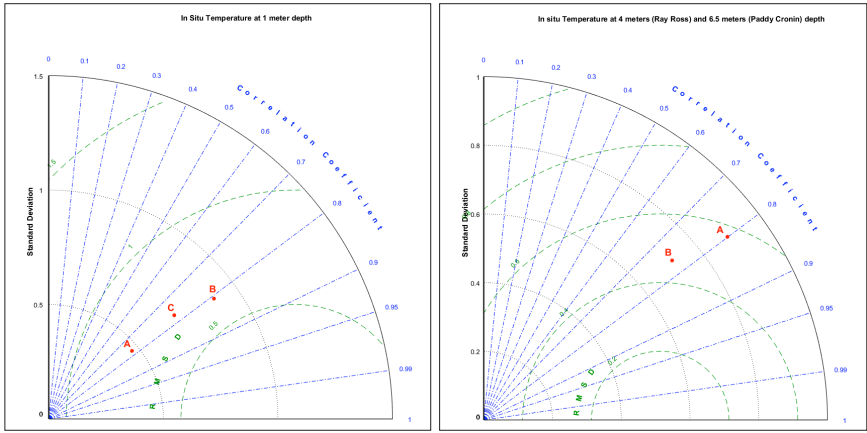

Fig. 2. Statistical comparison between observed and simulated values of in situ temperature in all available depths for all stations in Kilmakilloge Harbour.

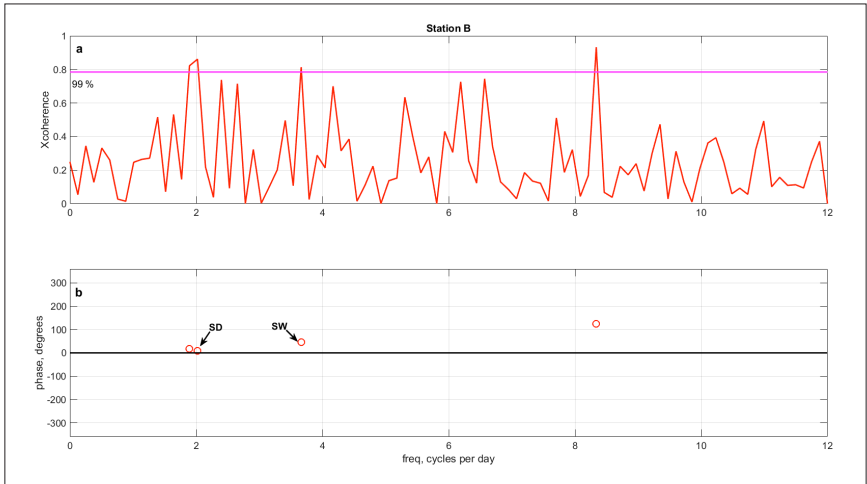

Fig. 3.(a) Coherence diagram and (b) phase difference in degrees for station B in Kilmakilloge Harbour. SD denotes semi-diurnal and SW shallow water quarter semi-diurnal constituents, respectively.

model. One other possible issue, although its contribution may be of less importance compared to the absence of realistic data for rivers, could be the choice of initial condition for the model. MI's Bantry Bay operational model does not include any rivers inside the Kenmare Harbour. But again, we assume that this does not have the same impact on our results because the model converges relatively quickly after a few days. Thus we arrive to the conclusion that the model in its current form overestimates mixing inside Kilmakilloge Harbour. Our first aim for future experiments is to use other sources for freshwater discharges once they are available and second to explore the different parameterizations of GLS vertical mixing scheme before we setup the coupled physical – biogeochemical – shellfish simulation.

Acknowledgements

This work has been performed and supported in the framework of the project "Tools for Assessment and Planning of Aquaculture Sustainability (TAPAS)", funded by the European Union's Horizon 2020 research and innovation programme under grant agreement N° 678396.

References

- Dabrowski, T., Lyons, K., Nolan, G., Berry, A., Cusack, C., and Silke, J., (2016). Harmful Algal Bloom warning system for SW Ireland. Part I: description and validation of an operational forecasting model. *Harmful Algae*, 53, 64-76.
- Heidvogel, D. B., Arango, H. G., Hedstrom, K., Beckmann, A., Malanotte-Rizzoli, P. and Shchepetkin, A. F. (2000). Model evaluation experiments in the North Atlantic Basin: Simulation in non-linear terrain-following coordinates. *Dynamics of Atmosphere and Oceans*, 32, 239-281.
- Shchepetkin, A. F., McWilliams, J., C., (2003). A method for computing horizontal pressure gradient force in a oceanic model with a nonaligned vertical coordinate. *Journal of Geophysical Research*, 108, 1-34.
- Shchepetkin, A., F., McWilliams, J., C., (2005). The regional oceanic modelling system (ROMS): a split-explicit, free-surface, topography-following-coordinate oceanic model. *Ocean Modelling*, 9, 347-404.
- Sikiric, M., D., Janekovic, L., Kuzmic, M., (2009). A new approach to bathymetry smoothing is sigma coordinate ocean models. *Ocean Modeling*, 29, 128-136.
- Smolarkiewicz, P., K., Margolin, L., G., (1998). MPDATA: A Finite-Difference solver of geophysical flows. *Journal of Computational Physics*, 2, 459-480.

Umlauf, L., Burchard, H., (2003). A generic length scale equation for geophysical turbulence models. *Journal of Marine Research*, 61, 235-265.

Warner, J., C., Sherwood, C., R., Arango, H., G., and Signell, R., P., (2005). Performance of four turbulence closure methods implemented using a generic length scale method. *Ocean Modeling*, 8, 81-113.

Wilkin, J., L., Arango, H., G., Haidvogel, D., B., Lichtenwalner, C., S., Durski, S., M., and Hedstrom, K., S., (2005). A regional ocean modeling system for the long-term ecosystem observatory. *Journal of Geophysical Research*, 110, 1-13.

PERFORMANCE AND QUALITY ASSESSMENT OF THE CURRENT COPERNICUS MARINE SERVICE GLOBAL OCEAN MONITORING AND FORECASTING REAL-TIME SYSTEM

J.-M. Lellouche⁽¹⁾, O. Le Galloudec⁽¹⁾, E. Greiner⁽²⁾, G. Garric⁽¹⁾,
C. Régnier⁽¹⁾, M. Clavier⁽¹⁾, M. Drévillon⁽¹⁾, F. Gasparin⁽¹⁾ and Y. Drillet⁽¹⁾

⁽¹⁾ Mercator Océan, Ramonville Saint Agne, France. jlellouche@mercator-ocean.fr

⁽²⁾ CLS, Ramonville Saint Agne, France

Abstract

Since October 19, 2016, and in the framework of Copernicus Marine Environment Monitoring Service (CMEMS), Mercator Ocean delivers, in real-time, daily services (weekly analyses and daily 10-day forecasts) with a new global 1/12° high resolution system. The model component is the NEMO platform driven at the surface by the IFS ECMWF atmospheric analyses and forecasts. Ocean observations are assimilated by means of a reduced-order Kalman filter with a 3D multivariate modal decomposition of the forecast error. Along track altimeter data, satellite Sea Surface Temperature, sea-ice concentration, and in situ temperature and salinity (T/S) vertical profiles are assimilated. A 3D-VAR scheme provides a correction for the slowly-evolving large-scale T/S biases.

An assessment of the hindcasts (2007-2016) has been conducted and has highlighted improvements compared to the previous system. Since the real-time implementation of this new system, the scientific qualification exercise was completed with the evaluation of the forecasts. Moreover, in parallel with the operational system, two other simulations over the same period have been performed. The first one is a free simulation and the second one benefits only of the 3D-VAR large-scale biases T/S correction. Some comparisons between the three simulations have been conducted to quantify the impact of each component in the system.

Keywords: ocean model, real-time, forecast, analysis, data assimilation

1. Introduction

Since May 2015, Mercator Ocean opened the CMEMS and is in charge of the global eddy resolving ocean analyses and forecast. In this context, R&D activities have been conducted at Mercator Ocean these last years to improve the real-time 1/12° high resolution (eddy-resolving) global system (V1 system). Since October 19, 2016, Mercator Ocean delivers in real-time daily services (weekly analyses and daily 10-day forecasts) with a new global 1/12° system (V2 system). The ocean/sea-ice model and the assimilation scheme benefit from the following main updates: large-scale and objective correction of atmospheric quantities with satellite observations; new freshwater runoff from ice sheets melting; global steric effect added to the model sea level; new Mean Dynamic Topography, taking into account the last version of GOCE geoid; new adaptive tuning of some observational errors; new Quality Control on the assimilated temperature and salinity vertical profiles, based on dynamic height criteria; assimilation of satellite sea-ice concentration; weak constraint imposed on temperature and salinity in the deep ocean (below 2000m), to prevent drift.

2. Evaluation of the system

2.1 Sea Surface Temperature

We checked time series of the mean and the RMS of the misfit (observation minus forecast) between the observed Sea Surface Temperature (SST) and the model. When compared to OSTIA (Operational Sea Surface Temperature and Sea-Ice Analysis) SST data, the model is warmer than the observations by 0.1°C on average, and the RMS error is around 0.45°C (Fig. 1). Seasonal fluctuations of the SST biases on global average can be seen as a lack of stratification in the model, probably linked to vertical mixing, which causes stronger mid-latitude cold biases during (boreal) summer (and a warm bias between 50m and 100m). For *in situ* SST, the bias is smaller, suggesting that OSTIA might be colder than *in situ* near surface observations on global average.

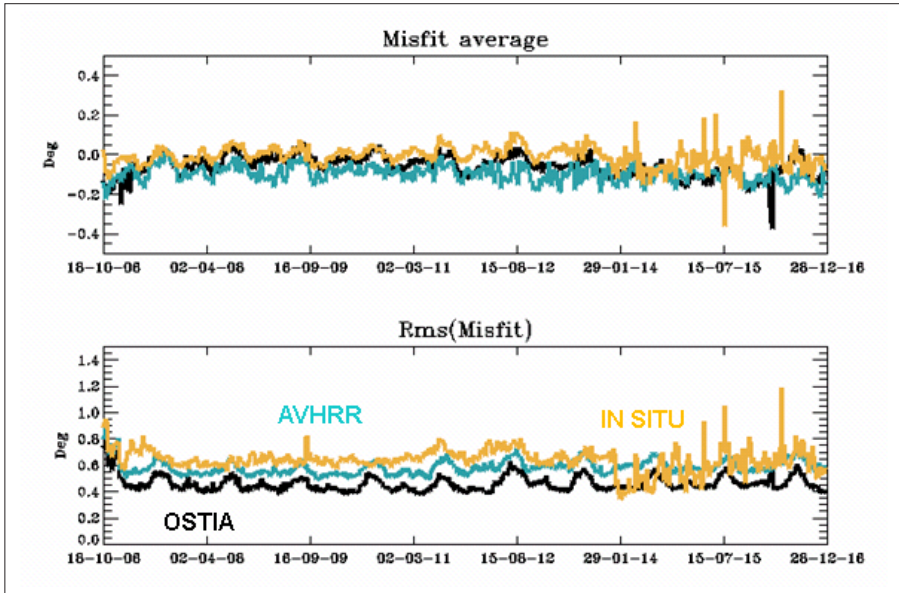

Fig. 1. Sea Surface Temperature (°C) global misfit average (top) and RMS (bottom) for OSTIA observations (black line, assimilated), NOAA AVHRR observations (blue line, not assimilated), and in situ observations (orange line, assimilated), for the (October 2006 - December 2016) hindcast period.

2.2 Sea Surface Temperature

For the T/S vertical profiles, we checked time series of the RMS of the difference between the model analyses and the observations, for temperature on the left and for salinity on the right (Fig. 2), on average over the whole water column. The time evolutions of temperature and salinity RMS departures from *in situ* observations are shown for climatological estimates (used here as a reference), V1 previous system and V2 new system, allowing inter-comparisons. On global average, the V2 system slightly degrades the temperature statistics (-0.03°C) but it significantly improves the salinity statistics (+0.1psu). This allows to have a more accurate description of the water masses. We can also notice that the systems are always better than the climatology Levitus WOA13.

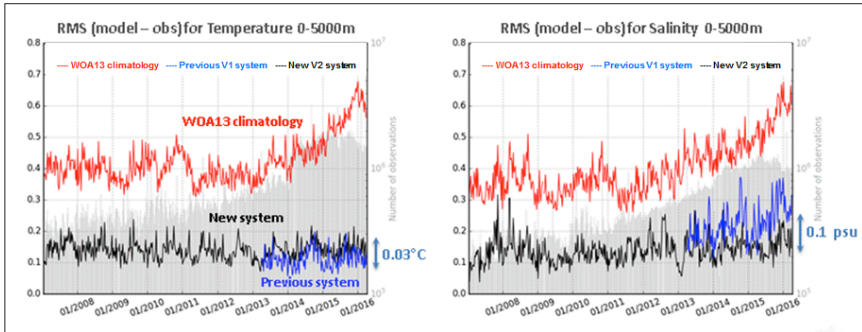

Fig. 2. Time series of the 0-5000m RMS of the difference between the in situ observations and model analysis for V1 (previous, blue line) and V2 (new, black line) systems and the Levitus WOA13 climatology (red line). Left panel: temperature ($^{\circ}\text{C}$), right panel: salinity (psu). The number of available observations appears as grey shading in the background.

2.3 Sea Level Anomaly

For the Sea Level Anomaly (SLA), the V2 system is closer to altimetric observations than V1 with a forecast RMS difference of around 6cm instead of 7cm. More precisely, Fig. 3 represents the SLA residual and the RMS of the SLA residual for year 2015, comparing the V1 system on the left and the V2 system on the right. The SLA mean and RMS errors are considerably reduced in the V2 system compared to V1, in nearly all regions of the ocean. This is probably due to the use of the method to adapt the observations errors online, which yields to more information from the observations being used.

These improvements lead to a better mass balance and a better Global Mean Sea Level (GMSL) trend. Fig. 4 represents the GMSL evolution over the new simulation period where we checked the model by comparing the results with recent estimated trends from Chambers *et al.*, (2017). We find for the model a GMSL trend of 3.09mm/y which is consistent with AVISO estimates (3.17 ± 0.671). This trend corresponds to 2.2mm/y we have added to the prescribed runoffs in order to represent the recent estimate of the global mass addition to the ocean (from glaciers, land water storage changes, Greenland and Antarctica ice sheets mass loss), and 1mm/y which represents the steric effect that can be diagnosed from the model.

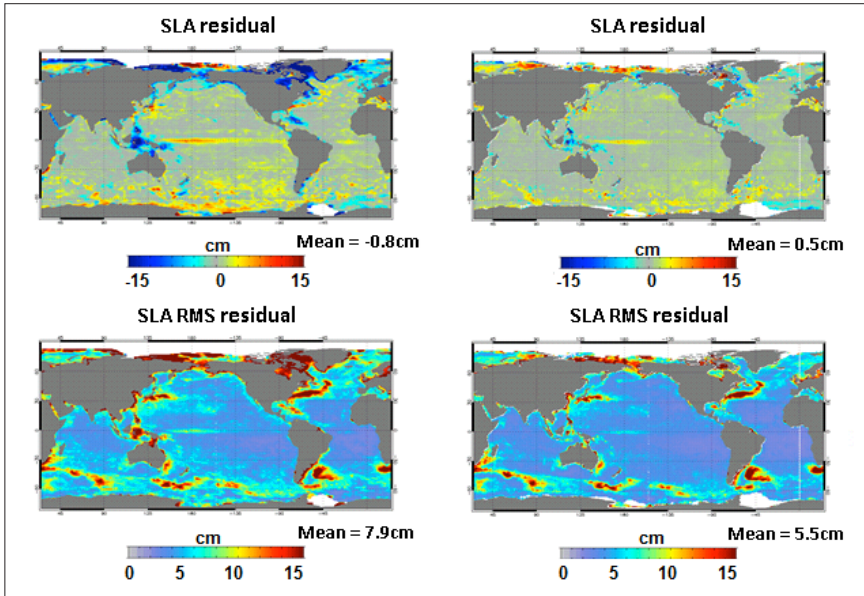

Fig. 3. Upper panel: SLA residual (cm) and lower panel: RMS of SLA residual (cm) for the V1 system (on the left) and the V2 system (on the right).

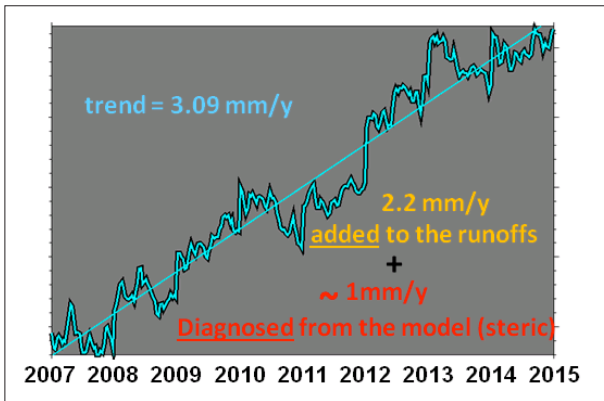

Fig. 4. Global Mean Sea Level model evolution.

2.4 Sea-ice concentration

For sea-ice concentration, which is assimilated in the V2 system, we can see in Fig. 5 that, as expected, the V2 system is actually closer to the observations than the V1 system in the Arctic and in the Antarctic oceans.

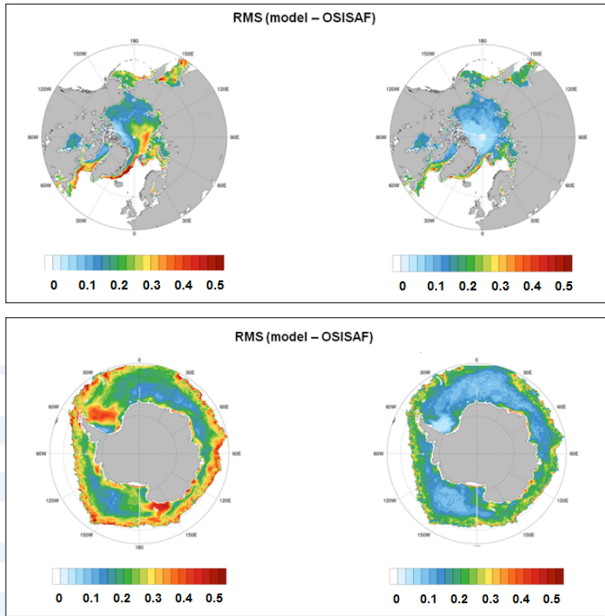

Fig. 5. RMS residual error of sea-ice concentration for the V1 system (on the left) and the V2 system (on the right).

2.5 Forecast validation

The performance of the daily 10-day forecasts has been checked. Fig. 6 represents temperature RMS differences (model minus observation) for best analysis and for 1-day, 3-day, 5-day, 7-day and 9-day forecasts. As expected, the best analysis has the lower RMS and this RMS increases with the forecast length. Similar results are obtained for salinity, SLA and SST.

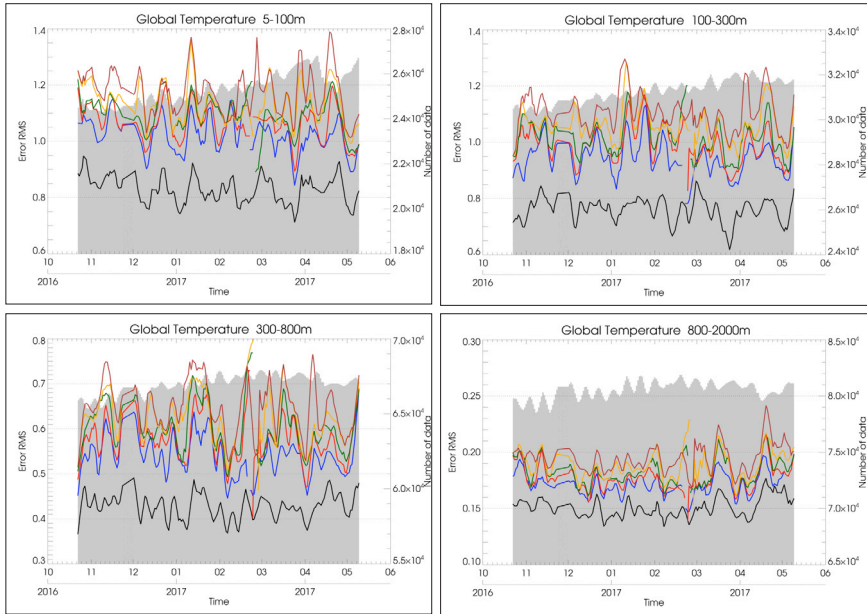

Fig. 6. Temperature ($^{\circ}\text{C}$) RMS differences (model minus observation) in the 5-100m, 100-300m, 300-800m and 800-2000m layers. Statistics are displayed for best analysis (black line) and for 1-day (blue line), 3-day (red line), 5-day (green), 7-day (orange line) and 9-day (brown line) forecasts. The number of available observations appears in grey in the background.

2.6 Comparison PSY4free/PSY4bias/PSY4oper

The catch-up to real-time of the OPERational system was run over the October 2006 – October 2016 period. Two other simulations over the same period have been performed. The first one is a FREE simulation (without any data assimilation) and the second one only benefits from the 3D-VAR large-scale BIASes correction in temperature and salinity. Fig. 7 shows a comparison between this triplet of PSY4 simulations and CMEMS/AVISO Merged-Gridded SLA heights in delayed time on a $\frac{1}{4}^\circ$ regular horizontal grid with a 1-day temporal resolution (Pujol *et al.*, 2016). Fig. 7 (a,b,c) shows the 2007-2014 SSH variability for the three simulations. SSH variability difference is defined as the difference of SSH variances from PSY4 simulations and the AVISO product (Fig. 7 (d,e,f)). Comparing to the variability of the AVISO product, we can see that, in the FREE simulation, the fronts in high mesoscale variability regions such as the Gulf Stream, the Kuroshio, the Agulhas current or the Zapiola eddy are misplaced. In the BIAS simulation, these fronts are better positioned thanks to the large-scale correction of temperature and salinity. However, this simulation presents more energy compared to AVISO, which can be explained by the cascading energy from large to small scales or the impact of instabilities mechanism related to mean currents. The mesoscale features are well constrained in the OPER simulation with the information coming from satellite data.

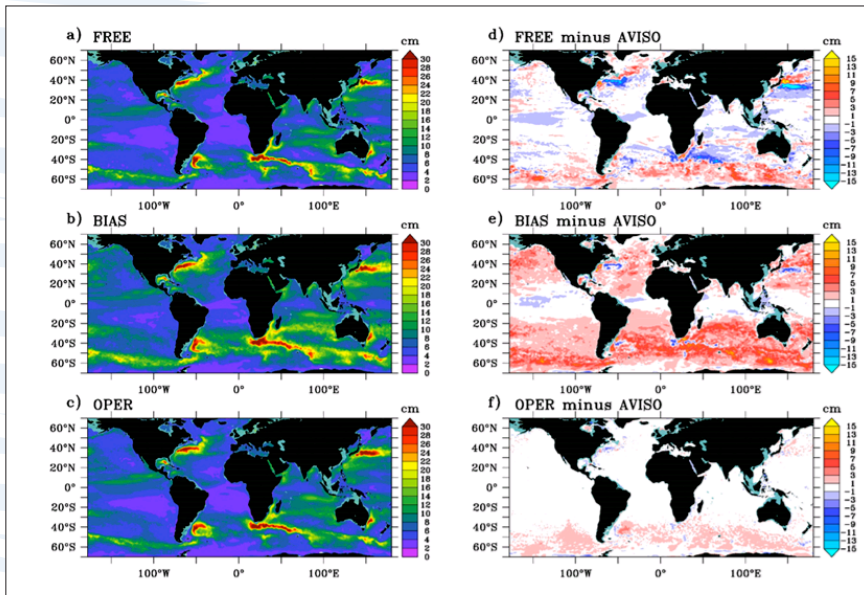

Fig. 7. 2007-2014 SSH variability (diagnostics made with 1 point every 3 horizontally and 1 day every 5) of the $1/12^\circ$ PSY4 simulations (a,b,c) and difference of SSH model variability with the one of AVISO product (d,e,f).

3. Conclusion

The new global system has a quite good statistical behavior with an accurate representation of the water masses, the surface fields and the mesoscale activity. Most of the components of the new system are improved compared to the previous system: global mass balance, 3D T/S, Sea Surface Height, sea-ice, currents. Weak assimilation of climatological T/S profiles below 2000m prevents some drift in the deep ocean. Next updates will concern the assimilation of satellite Sea Surface Salinity and the development of a 4D analysis in the assimilation scheme.

References

Chambers, D.P., A. Cazenave, N. Champollion, H. Dieng, W. Llovel, R. Forsberg, K. von Schuckmann, and Y. Wada (2017). Evaluation of the global mean sea level budget between 1993 and 2014. *Survey in Geophysics*, 38 (1), 309-327, doi:10.1007/s10712-016-9381-3.

Pujol, M.-I.I., Faugère, Y., Taburet, G., Dupuy, S., Pelloquin, C., Ablain, M. and Picot, N. (2016). DUACS DT2014: the new multi-mission altimeter data set reprocessed over 20 years, *Ocean Science*, 12, 1067-1090, doi:10.5194/os-12-1067-2016.

OVERVIEW OF CMEMS BAL MFC SERVICE AND DEVELOPMENTS

L. Tuomi⁽¹⁾, J. She⁽²⁾, I. Lorkowski⁽³⁾, L. Axell⁽⁴⁾, P. Lagemaa⁽⁵⁾, F. Schwichtenberg⁽³⁾ and V. Huess⁽²⁾

⁽¹⁾ Finnish Meteorological Institute, Helsinki, Finland. laura.tuomi@fmi.fi

⁽²⁾ Danish Meteorological Institute, Copenhagen, Denmark

⁽³⁾ Bundesamt für Seeschifffahrt und Hydrographie, Hamburg, Germany

⁽⁴⁾ Swedish Meteorological and Hydrological Institute, Norrköping, Sweden

⁽⁵⁾ Marine System Institute, Tallinn University of Technology, Tallinn, Estonia

Abstract

Copernicus Marine Service (CMEMS) model component for the Baltic Sea is provided by a consortium formed by five national oceanographic institutes around the Baltic Sea: DMI-Denmark, BSH-Germany, FMI-Finland, MSI Tallinn University-Estonia and SMHI-Sweden. All five institutes have national obligations within operational oceanography. The consortium builds on a philosophy to join forces within operational oceanography in the Baltic Sea and shares the operational work load behind the Baltic service. We will present progress of our Baltic Sea model products during the past 2.5 years within the CMEMS contract with Mercator-Ocean. The modelling systems presented are HBM for physical, ERGOM for biogeochemical and WAM for wave analysis and forecasts and HIROMB for the physical reanalysis. We also describe the product quality procedures used to ensure the quality of the BAL MFC forecast and reanalyses products.

Keywords: CMEMS, BAL MFC, HBM, ERGOM, WAM, MME, product quality

1. Introduction

The Baltic Monitoring and Forecasting Centre (BAL MFC) provides forecasts and reanalyses of the Baltic Sea physical and biogeochemical state as part of the Copernicus Marine Environment Monitoring Service (CMEMS). The BAL MFC consortium consists of five institutes from five different countries: Danish Meteorological Institute (DMI), Bundesamt für Seeschifffahrt und Hydrographie, Germany (BSH), Finnish Meteorological Institute (FMI), Marine Systems Institute at Tallinn University of Technology, Estonia (MSI) and Swedish Meteorological and Hydrological Institute (SMHI). The CMEMS BAL MFC service started in 2015 based on a system built during the MyOcean projects. At the first stage, physical and biogeochemical forecasts were made available. The latest version upgrade to the physical and biogeochemical system was in April 2015. Also at

that time, waves entered the CMEMS service and wave forecasts for the Baltic Sea area were made available. The physical, biogeochemical and wave analysis and forecasts are provided with 1 nmi horizontal resolution for the Baltic Sea. The physical and biogeochemical analysis and forecast are produced using the coupled model HBM-ERGOM and the wave forecast with the WAM model. The physical reanalyses of the Baltic Sea currently available at CMEMS are produced with the HIROMB model using 3 nmi horizontal resolution.

The brackish Baltic Sea is a semi-enclosed sea, in which the physical processes are strongly affected by water and mass transport between the Baltic and the North Sea, the voluminous, river discharge and variable atmospheric forcing. A Baltic Sea operational system should be able to resolve the specific physical features, such as the semi-permanent halocline, seasonal thermocline and seasonal ice cover, with good accuracy. Furthermore, the storm surge and low sea level events, that affect the shipping, should be well reproduced by the model. Upwelling, bottom oxygen depletion, harmful algae blooms and the seasonal variation of nutrients and biomass are also key characteristics of the Baltic Sea. The BAL MFC operational physical-biogeochemical model HBM (HIROMB-BOOS-Model) – ERGOM (Ecological Regional Ocean Model), has been developed in the past decade to solve these challenges (She *et al.*, 2007; Berg and Weismann Poulsen, 2012; Wan *et al.*, 2013; Weismann Poulsen *et al.*, 2014).

2. HBM

HBM is a three-dimensional, hydrostatic, free-surface, baroclinic ocean circulation and sea ice model. The model has fully dynamic two-way nesting (Berg and Weismann Poulsen, 2012), which makes it an excellent tool to model the complex configuration of basins and different types of coastlines of the Baltic Sea. The model has a high level of rigorous testing and standardisation, an efficient hybrid OpenMP-MPI memory parallelization. Portability and model correctness in term of reproducible output are key pillars of HBM model development (Weismann Poulsen *et al.*, 2014).

HBM has been shown to forecast sea level and its extremes with high accuracy (Golbeck *et al.*, 2017). Furthermore, it can describe the transports and dynamics between the North Sea and Baltic Sea, which was shown e.g. in the simulation of the Major Baltic Inflow events in the past few years. Recent model developments include improvements of sea ice thermodynamics, which gives better ice coverage both in ice formation and melting, and fast ice description in the ice module, accounting for the formation, consolidation and disintegration of fast ice, and the advance and retreat of its front.

2.1 Data assimilation –PDAF

The data assimilation group in the BAL MFC has been working on a common Parallel Data Assimilation Framework – PDAF (Nerger and Hiller, 2013). Satellite level 3 Sea Surface Temperature (SST) data are assimilated in a PDAF-HBM offline system. The filter used is Localized Error Subspace Transform Ensemble Kalman Filter (LESTKF). Preliminary results show that both SST and sea ice are improved by using data assimilation. It is expected that the SST assimilation will be part of the next version BAL MFC operational forecasting system (to be launched in April 2018).

3. Biogeochemical model ERGOM

The biochemical model ERGOM (Neumann, 2000) is online-coupled with the HBM model. In the present operational setup, there are 12 biogeochemical state variables. The model parameters have been calibrated for the CMEMS setup with observations from the period 2000-2014 (Wan *et al.*, 2012, Golbeck, 2017).

The recent developments in the Baltic Sea ERGOM model include improving the chlorophyll calculation. Contrary to the former version, where the chlorophyll was calculated by using a constant chlorophyll to nitrogen ratio, the new version takes into account that the chlorophyll to nitrogen ratio is not constant in living phytoplankton. The synthesis of chlorophyll is always related to costs in the phytoplankton cell itself, thus a minimal Chl:N ratio should be needed at optimal light conditions. Phytoplankton can compensate for lower light levels by increasing the Chl:N ratio up to a certain maximum. Below this light level related growth will decline. Light levels above the optimal light, may support growth up to a certain point, where photooxidation comes into play and growth declines due to damage off the photopigments. Photooxidation is not, however, included in the ERGOM model yet. The model uses a bulk parameterisation for the CHL:N following Doron *et al.*, (2013). The CHL:N ratio is constrained by a physiological sensible maximum and minimum. The ratio is then determined by the optimal light and the actual light conditions. The parameters were adjusted by comparing model results and data.

Additionally, a new calculation for the attenuation of light was implemented following Neumann *et al.*, (2015). This approach includes a dynamic parameterisation of CDOM (coloured dissolved organic matter) with salinity, which proved to be suitable for the Baltic Sea. Furthermore, to validate the calculation of the light attenuation the diagnostic calculation of Secchi Depth (Neumann *et al.*, 2015) was included. For the calculation of the new attenuation coefficient a new state variable was introduced, the labile dissolved organic nitrogen (LDON). First results of Secchi Depth showed good accordance with in situ data (Fig. 1) after the water specific attenuation coefficient was adjusted differently from Neumann *et al.*, (2015).

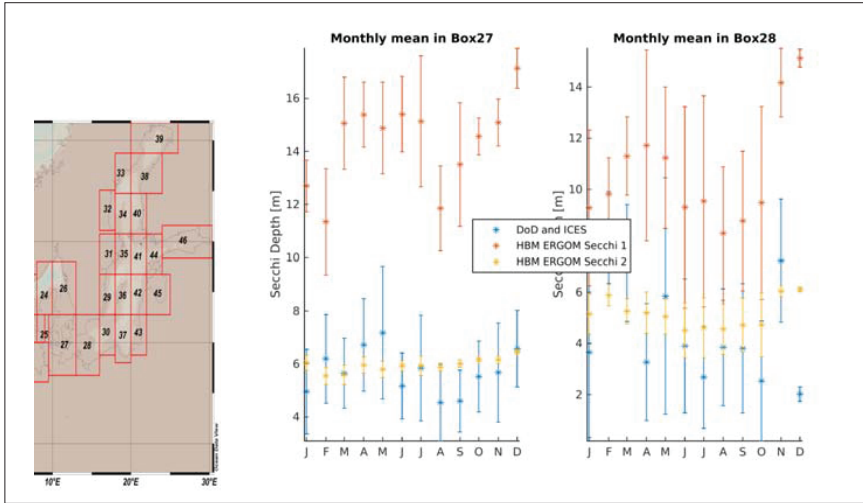

Fig. 1. Overview of boxes used for validation (left). Validation of Secchi Depth showing mean and standard deviation for every month in 2012 in box 27 and 28. The blue dots show observation from the ICES database and the German Oceanographic Database (DoD) merged together. The red dots show result for the Secchi Depth of a first parameterisation for the light attenuation following Neumann et al. (2015), while the yellow dots show the results from the final realisation with a different background coefficient for water of 0.18 m^{-1} . The same rule applies for the next sections.

4. WAM

The BAL MFC wave analysis and forecast is produced with the wave model WAM cycle 4.5.4. The horizontal resolution is 1 nmi (~1.85 km) with open boundary at Skagerrak, in which boundary conditions from ECMWF’s deterministic wave forecast are employed. Wind forcing is taken from FMI’s high-resolution Numerical Weather Prediction system HARMONIE, with 2.5km resolution. During the ice season, the ice concentration is accounted for by excluding grid points that have ice concentration of over 30 % from calculations. The quality of the wave product was shown to be good in the pre-operational qualification, with a slight tendency to overestimate the significant wave height. The BAL MFC wave forecast is presented in more detail in the extended abstract Tuomi et al., (2017): CMEMS Baltic Monitoring and Forecasting Centre: High-resolution wave forecasts in the seasonally ice-covered Baltic Sea.

5. Reanalysis system

The BAL MFC physical reanalysis system, presently available in the CMEMS catalogue, is based on ice-ocean circulation model HIROMB (Wilhelmsson 2002; Funkquist and Kleine 2007; Axell 2013). The reanalysis covers the period 1989-2015. The horizontal resolution of the modelling system is 3 nmi (ca 5.5 km) and in the vertical there are up to 50 levels. The vertical resolution is 4m down to 80m depth. At the lateral boundaries, sea level is provided from the storm surge model NOAMOD, and salinity, temperature and ice from climatology. As meteorological forcing, data from the reanalysis project Euro4M is used and the river runoff is obtained from the hydrological model E-HYPE. The HIROMB model is run in combination with 3D Ensemble Variational (3D EnVar) Data Assimilation (Axell and Liu, 2016).

The BAL MFC reanalysis in the CMEMS product catalogue V3 consists only of a physical part, but a coupled physical-biogeochemical reanalysis will soon be updated to the catalogue.

6. Product quality

The quality of the BAL MFC forecast products is routinely monitored using a validation framework (Lagemaa *et al.*, 2013) that was originally developed in the MyOcean projects and is being further developed during the CMEMS phase 1 contract. The validation framework consists of tools for validation of timeseries data (mooring stations), profile data (profiling stations), along track data (ferrybox) and 2D field data (SST, Chl-a, etc).

The product quality monitoring in CMEMS consists of two steps: 1) preoperational qualification, which ensures the readiness of the product for operational production, and 2) operational validation, which demonstrates the quality of the products during operational production. The validated parameters are: sea surface height, temperature, salinity and sea ice for forecast and multiyear products, mixed layer depth for forecast and Chl-a, Nitrogen, Phosphorus and Oxygen for the bio forecast product.

In addition to the validation framework, BAL MFC utilises a multi model ensemble (MME) method to estimate the model accuracy in near real time (Golbeck *et al.*, 2015). In the Baltic Sea the MME constitutes of different forecasting models, run at different operational centres that are differing in model code meteorological forcing, boundary conditions, bathymetry, model resolution and data assimilation schemes. The MME includes the following parameters: sea surface height, sea surface currents, sea surface salinity, sea surface temperature (SST), sea bottom salinity and sea bottom temperature. The MME for the Baltic Sea is available at the BOOS web site (www.boos.org).

References

- Axell, L.B. (2013). BSRA-15: A Baltic Sea Reanalysis 1990–2004, Reports Oceanography, Swedish Meteorological and Hydrological Institute, January.
- Axell, L.B. and Liu, Y. (2016). Application of 3-D ensemble variational data assimilation to a Baltic Sea reanalysis 1989–2013, *Tellus* 68, doi: 10.3402/tellusa.v68.24220.
- Berg, P., and Weismann Poulsen, J. (2012). Implementation details for HBM. DMI Technical Report No. 12-11. Copenhagen, 149 pp. (Available at: www.dmi.dk/fileadmin/Rapporter/TR/tr12-11.pdf).
- Doron, M., P. Brasseur, J.-M. Brankart, S. N. Losa and A. Melet (2013). Stochastic estimation of biogeochemical parameters from Globcolour ocean colour satellite data in a North Atlantic 3D ocean coupled physical–biogeochemical model. *Journal of Marine Systems* 117–118(0): 81–95.
- Funkquist, L. and Kleine, E. (2007). HIROMB: An Introduction to HIROMB, an Operational Baroclinic Model for the Baltic Sea. *Report Oceanography*, 37. Swedish Meteorological and Hydrological Institute, Norrköping, Sweden.
- Golbeck I., Li X., Janssen F., Brüning T., Nielsen J.W., Huess V., Söderkvist J., Büchmann B., Siiriä S.-M., Vähä-Piikkiö O., Hackett B., Kristensen N.M., Engedahl H., Blockley E., Sellar A., Lagema P., Ozer J., Legrand S., Ljungemyr P., Axell L. (2015). *Uncertainty estimation for operational ocean forecast products—a multi-model ensemble for the North Sea and the Baltic Sea*. *Ocean Dynamics*, 65 (12) 1603–1631.
- Golbeck I., Izotova J., Jandt S., Janssen F., Lagema P., Brüning T., Huess V., Hartman A. (2017). Quality Information Document (QUID) Baltic Sea Physical Analysis and Forecasting Product BALTICSEA_ANALYSIS_FORECAST_PHY_003_006: issue 4.0 <http://marine.copernicus.eu/documents/QUID/CMEMS-BAL-QUID-003-006.pdf>
- Lagema P., Janssen F., Jandt S., and Kalev K. (2013). Pers. Comm. General Validation Framework for the Baltic Sea in GODAE OceanView Symposium Poster. Baltimore, USA (<http://www.godae.org/~godae-data/Symposium/GOV-posters/S3.3-08-Lagema.pdf>, 26.03.2017)
- Nerger, L., Hiller, W. (2013). Software for Ensemble-based Data Assimilation Systems - Implementation Strategies and Scalability. *Computers and Geosciences*, 55, 110–118. doi:10.1016/j.cageo.2012.03.026
- Neumann, T. (2000). Towards a 3D-ecosystem model of the Baltic Sea. *Journal of Marine Systems*, 25, 405–419.
- Neumann, T., H. Siegel and M. Gerth (2015). A new radiation model for Baltic Sea ecosystem modelling. *Journal of Marine Systems* 152: 83–91.
- She J., P. Berg and J. Berg. (2007). Bathymetry impacts on water exchange modelling through the Danish Straits. *J. Mar. Sys.* 65, 450–459

Tuomi, L., Vähä-Piikkiö, O., Siili, T. and Alari, V. (2017) CMEMS Baltic Monitoring and Forecasting Centre: High-resolution wave forecasts in the seasonally ice-covered Baltic Sea. 8th EuroGOOS, 3.-5.10.2017, Bergen, Norway. Book of extended abstracts.

Wan, Z., She, J., Maar, M., Jonasson, L., and Baasch-Larsen, J. (2012). Assessment of a physical-biogeochemical coupled model system for operational service in the Baltic Sea. *Ocean Science* 8, 683-701.

Wan, Z., Bi, H., and She, J. (2013). Comparison of Two Light Attenuation Parameterization Focusing on Timing of Spring Bloom and Primary Production in the Baltic Sea. *Ecological Modelling*, 259, 40-49.

Weismann Poulsen, J., Berg, P., and Karthik, R. (2014). Better Concurrency and SIMD On The HIROMB-BOOS-MODEL (HBM) 3D Ocean Code" In: J. Jeffers and J. Reinders (eds.).High Performance Parallelism Pearls: Multicore and Many-core Programming Approaches. *Morgan Kaufmann Publishing*.

Wilhelmsson, T. (2002). Parallellization of the HIROMB Ocean Model. Licentiate Thesis. Royal Institute of Technology, Department of Numerical and Computer Science, Stockholm, Sweden.

Zhuang, S. Y., W. W. Fu, and J. She. (2011). A pre-operational three dimensional variational data assimilation system in the North/Baltic Sea. *Ocean Sci.*, 7, 771–781, doi:10.5194/os-7-771-2011.

CMEMS BALTIC MONITORING AND FORECASTING CENTRE: HIGH-RESOLUTION WAVE FORECASTS IN THE SEASONALLY ICE-COVERED BALTIC SEA

L. Tuomi⁽¹⁾, O. Vähä-Piikkiö⁽¹⁾, T. Siili⁽¹⁾ and V. Alari⁽²⁾

⁽¹⁾ Finnish Meteorological Institute, Helsinki, Finland. laura.tuomi@fmi.fi

⁽²⁾ Marine System Institute, Tallinn University of Technology, Tallinn, Estonia

Abstract

The Baltic Monitoring and Forecasting Centre (BAL MFC) is providing high resolution wave forecasts for the Baltic Sea as part of the Copernicus Marine Service. The BAL MFC wave forecasting system is based on wave model WAM cycle 4.5.4. The model has a horizontal resolution of ca. 1 nmi (1.852km) with open boundary at the Skagerrak. The wind forcing is provided by FMI's numerical weather prediction system HARMONIE (2.5km resolution). The wave forecast system accounts for the seasonal ice cover by excluding grid points that have ice concentration of over 30 % from calculations. The ice data are obtained from FMI's ice charts. For the next version upgrade, due on April 2018, methods to account for attenuation of wave energy in partly ice-covered areas will be implemented in the wave model. Also, the different characteristics of the Baltic Sea shorelines have been taken into account. E.g. to obtain sufficiently accurate wave forecasts also in coastal archipelagos of the northern Baltic Sea a method to account for unresolved islands with the given grid resolution is used. The quality of the BAL MFC wave forecasting system was evaluated by comparing a two year simulation period against wave buoy measurements. The quality of the wave model was found to be good, with slight tendency to overestimate the significant wave height. The capability of the BAL MFC wave forecast system was further evaluated in the pre-operational phase, when the storm 'Toini' (Jan 11th 2017) caused high waves in the Baltic Proper. The highest hindcast value of significant wave height at the Northern Baltic Proper buoy location during the storm was 7.8m, which was a good match to the measured maximum value of 8.0m.

Keywords: CMEMS, BAL MFC, WAM, Baltic Sea, archipelago, seasonal ice cover, extreme wave events

1. Introduction

The Copernicus Marine Environment Monitoring Service (CMEMS) is an open, free and integrated service for all marine areas surrounding Europe. CMEMS has been operational since May 2015 and is the successor of and based on the six-year pre-operational MyOcean demonstration service. Most recent addition to the CMEMS product portfolio is wave forecasts, which were launched in April 2017. For the Baltic Sea area, the wave forecasts are provided by the Baltic Monitoring and Forecasting Centre (BAL MFC), which is a consortium of five institutes, namely DMI (Denmark), BSH (Germany), FMI (Finland), MSI (Estonia) and SMHI (Sweden). Modelling systems producing the BAL MFC physical and biogeochemical forecasts and reanalyses and the product quality procedures employed in the BAL MFC are presented in Tuomi *et al.*, (2017b): Overview of CMEMS BAL MFC Service and Developments. The CMEMS products are available at <http://marine.copernicus.eu>.

2. Wave Forecast System

The BAL MFC wave analysis and forecast product is based on wave model WAM cycle 4.5.4 (Komen *et al.*, 1994). The model domain covers the Baltic Sea with 1 nmi (ca. 1.852km) horizontal resolution with open boundary at the Skagerrak (Fig.1). At the open boundary spectra from ECMWF's deterministic wave forecast are used. Wind forcing is provided by Numerical Weather Prediction system HARMONIE, which has a horizontal resolution of 2.5km. During ice season, the ice conditions are accounted for by excluding grid points that have ice concentration of over 30 % from calculations. The ice concentrations at each model grid point are evaluated based on FMI's ice charts also available at the CMEMS catalogue.

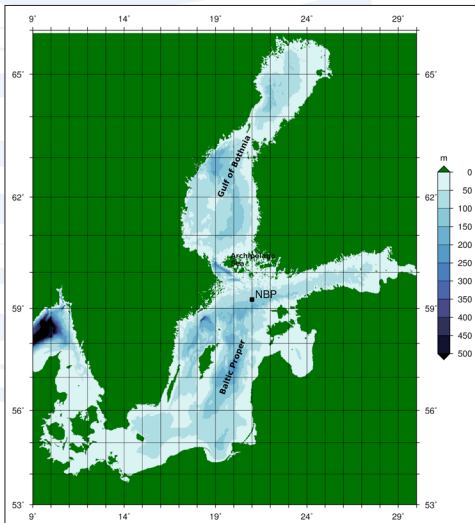

Fig. 1. Model domain and bathymetry of the BAL MFC wave forecast and the location of FMI's Northern Baltic Proper (NBP) wave buoy.

2.1 Unresolved islands

The shorelines of the northern Baltic Sea have irregular shape and they are covered with small islands and islets, much smaller than the model grid size. To account for the effect that this archipelago has on the attenuation of wave energy, a method to handle unresolved islands (e.g. Tolman, 2003) was implemented in the BAL MFC WAM model code. The method reduces the wave energy propagated from one grid cell to the next one, according to the shadowing effect caused by unresolved islands. Obstruction grids for the northern Baltic Sea archipelagos were compiled based on information available in coastal nautical charts using method presented by Tuomi *et al.*, (2014). The use of this method improves the quality of the coarser resolution forecasts in the coastal areas of the Baltic Sea (Tuomi and Björkqvist, 2014) and increases the usability of the forecasts in areas such as the Archipelago Sea, between the Baltic Proper and Gulf of Bothnia (Fig. 2, locations of basins shown in Fig. 1).

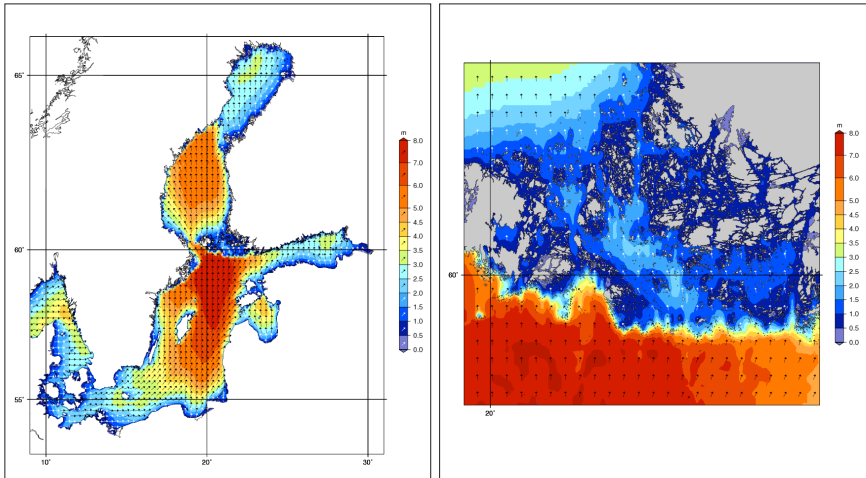

Fig. 2. Significant wave height and wave direction in the Baltic Sea (on the left) and the Archipelago Sea (on the right) on 11.1.2017 at 23 UTC. In the Archipelago Sea the wave model uses additional grid obstructions to account for the attenuation of wave energy due to islands and islets smaller than grid resolution (1 nmi).

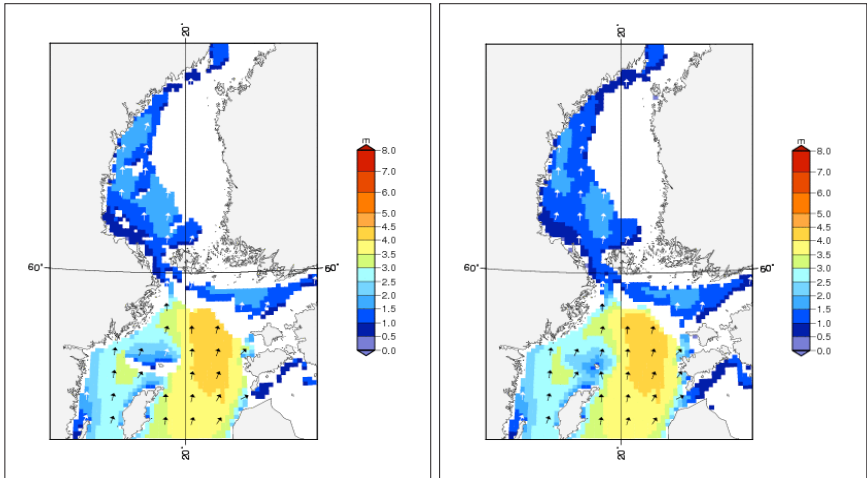

Fig. 3. Hindcast significant wave height and direction in the Gulf of Bothnia and northern Baltic Proper (Fig. 1) on March 9th 2011. On the left, grid points having ice concentration of over 30% were excluded from calculation and on the right, grid points with over 70% of ice concentration are excluded from calculations and ice concentrations less than 70% were taken into account as additional grid obstructions.

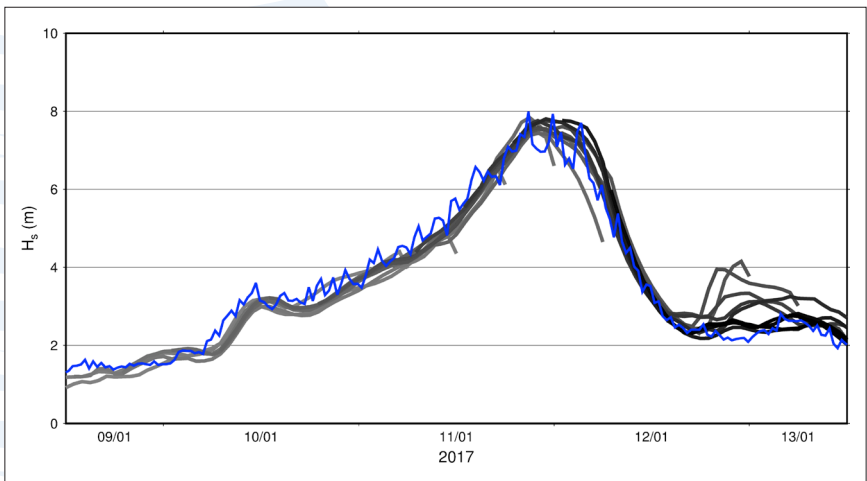

Fig. 4. Measured significant wave height during storm ‘Toini’ at the NBP wave buoy (blue) and forecast significant wave height from BAL MFC wave forecast. Forecast cycles run at 00, 06, 12 and 18 UTC, 9.-11.1.2017. Each grey line represent one forecast cycle with 54 h forecast length. The colour is darker the closer the forecast analysis time is to the observed maximum value.

2.2 Seasonal ice cover

To increase the usability of the wave forecasts in partially ice-covered sea areas during the ice season, the method to attenuate the wave energy was extended to ice. In areas where the ice concentration was less than 70%, the ice was treated as an additional grid obstruction, reducing the wave energy to propagate between the grid cells. Areas in which the ice concentration exceeded 70% were excluded from calculation by setting the wave energy to zero after each propagation time step. The use of this method allows forecasting waves, for example, in drift ice field, where the concentration of ice is not high enough to hinder the propagation of wave energy. But it accounts for the damping effect the ice has on waves, thus increasing the usability of wave forecasts in such areas (Fig. 3).

2.3 Storm 'Toini'

A significant wave height of 8m has only been recorded twice in the Baltic Sea. The record value is 8.2m, measured at the northern Baltic Proper wave buoy (location shown in Fig. 1) in December 2004. The second time was in January 2017 during storm 'Toini' when 8.0m was measured (Björkqvist *et al.*, 2017). The BAL MFC wave setup showed good accuracy in forecasting the growth of significant wave height during the storm and also quite well predicted the peak value (Fig. 4). The highest forecast value was 7.8m and already the forecast 48 h hours prior the event predicted that 7.5m would be exceeded. Also the length of the storm was well represented by the forecast system.

3. Product quality

The accuracy of the wave prediction system has been evaluated for the period June 2014 – May 2016 as part of the CMEMS preoperational qualification to ensure the quality of the forecast system. Data from nine Baltic Sea wave stations were used to evaluate the accuracy of modelled significant wave height and peak and mean wave periods. The wave forecast system had slight tendency to overestimate the significant wave height (bias = 0.09m, rmsd=0.27m) over the whole basin. The accuracy was found to be better in the open sea areas, for example against Northern Baltic Proper wave buoy, than against buoys that are closer to coastal areas. The quality of peak period resembled the typical quality of the Baltic Sea wave models (e.g. Tuomi *et al.*, 2008). Peak periods related to higher values of significant wave height were relatively well simulated, but peak periods related to small values (of $H_s < 1$ m) had large scatter. The bias of peak period over the whole domain was 0.003 s and rmsd 1.05 s). More detailed information about the product quality can be found in the CMEMS BAL MFC quality information document for wave product (Tuomi *et al.*, 2017a).

References

- Björkqvist, J.V., Tuomi L., Tollman N., Kangas A., Pettersson H., Marjamaa R., Jokinen H. and Fortelius C., (2017). Brief communication: Characteristic properties of extreme wave events in the Baltic Sea. *Nat. Hazards Earth Syst. Sci.* doi: 10.5194/nhess-2017-117.
- Komen G.J., Cavaleri L., Donelan M., Hasselmann K. , Hasselman S. & Janssen P.A.E.M. (1994). *Dynamics and modelling of ocean waves*. Cambridge University Press, Cambridge.
- Tolman, H. L., 2003. Treatment of unresolved islands and ice in wind wave models. *Ocean Modelling*, 5, 219-231.
- Tuomi, L., Vähä-Piikkiö, O., and Alari, V. (2017a). Quality Information Document (QUID) *Baltic Sea Wave Analysis and Forecasting Product BALTICSEA_ANALYSIS_FORECAST_WAV_003_010: issue 1.0*. <http://marine.copernicus.eu/documents/QUID/CMEMS-BAL-QUID-003-010.pdf>
- Tuomi, L., She, J., Lorkowski, I., Axell, L., Lagemaa, P., Schwichtenberg, F. Huess, V. (2017b). Overview of CMEMS BAL MFC Service and Developments. Extended abstract, 8th EuroGOOS conference, Bergen, Norway.
- Tuomi, L., H. Pettersson, C. Fortelius, K. Tikka, J.-V. Björkqvist and K. K. Kahma, (2014). Wave modelling in archipelagos. *Journal of Coastal Engineering* 83, 205-220.
- Tuomi, L., J.-V. Björkqvist, (2014). Wave forecasting in coastal archipelagos. Proceedings of 6th IEEE/OES Baltic Symposium, Tallinn 26-29 May 2014, Tallinn, DOI:10.1109/BALTIC.2014.6887855.

A 1/24° RESOLUTION MEDITERRANEAN PHYSICAL ANALYSIS AND FORECASTING SYSTEM FOR THE COPERNICUS MARINE ENVIRONMENT MONITORING SERVICE

E. Clementi⁽¹⁾, J. Pistoia⁽¹⁾, D. Delrosso⁽¹⁾, G. Mattia⁽¹⁾, C. Fratianni⁽¹⁾, A. Storto⁽²⁾, S. Ciliberti⁽²⁾, B. Lemieux⁽²⁾, E. Fenu⁽¹⁾, S. Simoncelli⁽¹⁾, M. Drudi⁽¹⁾, A. Grandi⁽¹⁾, D. Padeletti⁽¹⁾, P. Di Pietro⁽¹⁾ and N. Pinardi^(2, 3)

⁽¹⁾ INGV: Istituto Nazionale di Geofisica e Vulcanologia, Bologna, Italy. emanuela.clementi@ingv.it

⁽²⁾ Fondazione CMCC: Centro Euro-Mediterraneo sui Cambiamenti Climatici, Italy

⁽³⁾ Department of Physics and Astronomy, University of Bologna, Italy

Abstract

This study describes a new model implementation for the Mediterranean Sea that has been achieved in the framework of the Copernicus Marine Environment Monitoring Service (CMEMS). The numerical ocean prediction system, that operationally produces analyses and forecasts of the main physical parameters for the entire Mediterranean Sea and its Atlantic Ocean adjacent areas, has been upgraded by increasing the grid resolution from 1/16° to 1/24° in the horizontal and from 72 to 141 unevenly spaced vertical levels, by increasing the number of fresh water river inputs and by updating the data assimilation scheme. The model has a non-linear explicit free surface and it is forced by surface pressure, interactive heat, momentum and water fluxes at the air-sea interface. The focus of this work is to present the new modelling system which will become operational in the near future and the validation assessment including the comparison with an independent non assimilated dataset (coastal moorings) and quasi-independent (in situ vertical profiles and satellite) datasets. The results show that the higher resolution model is capable of representing most of the variability of the general circulation in the Mediterranean Sea, however some improvements need to be implemented in order to enhance the model ability in reproducing specific hydrodynamic features particularly the Sea Level Anomaly.

Keywords: Mediterranean Sea, Hydrodynamics, Numerical Model, Skill Assessment

1. Introduction

The Mediterranean Forecasting System, MFS, (Pinardi *et al.*, 2003, Pinardi and Coppini 2010, Tonani *et al.*, 2014) is providing since year 2000 numerical analysis and short term forecasts of the main physical parameters in the Mediterranean Sea. The reanalysis started much later (Adani *et al.*, 2011, Simoncelli *et al.*, 2016) and became a routine activity only from 2012. The modelling system has been upgraded during the years in the framework of several national and international projects and, since April 2015, is providing the physical component of the Med-MFC (Mediterranean Monitoring and Forecasting Center) for the Copernicus Marine Environment Monitoring Service (CMEMS) producing every week the analysis of the previous two weeks and providing daily updates of the following 10 days forecast at basin scale, which are freely available through the CMEMS Catalogue (<http://marine.copernicus.eu/>, Clementi *et al.*, 2017a).

The aim of this study is to provide a description of the recently upgraded Mediterranean Sea forecasting model and data assimilation implementation, which will enter in operation starting from October 2017, and to assess the quality of the new numerical system (namely EAS2) with respect to the previous version (namely EAS1) by comparing with *in situ* and satellite observation datasets.

2. MED-MFC physical modelling system until september 2017: EAS1

The present day Med-MFC numerical hydrodynamic system (so-called EAS1, Clementi *et al.*, 2017a, Oddo *et al.*, 2014) is composed by two elements: an Ocean General Circulation Model (OGCM) and a third generation Wave Model (coupling mechanism is described in Clementi *et al.*, 2017b); the numerical solutions are corrected by a data assimilation scheme based on 3DVAR. The modelling system is implemented in the Mediterranean Sea and its Atlantic Ocean adjacent areas in order to better represent the hydrodynamics at the Gibraltar Strait at 1/160 resolution and 72 vertical levels.

The OGCM code is based on NEMO (Nucleus for European Modelling, Madec 2008) version 3.4 and the model solves the primitive equations using the time-splitting technique, meaning that the external gravity waves are explicitly resolved, and with the linear free surface approximation. The model is forced by momentum, water and heat fluxes interactively computed by bulk formulae using the 6-hours (for the first 3 days of forecast a 3-hours temporal resolution is used), 1/8° horizontal-resolution operational analysis and forecast fields from the European Centre for Medium-Range Weather Forecasts (ECMWF) and the model predicted surface temperatures (details of the air-sea physics are in Pettenuzzo *et al.*, 2010). The surface water flux is computed as Evaporation minus Precipitation and Runoff. The evaporation is derived from the latent heat flux, the precipitation is provided by ECMWF at the same temporal resolution of the other atmospheric forcing fields, while 7 rivers are considered as volume inputs

provided by monthly mean datasets; moreover the Dardanelles Strait is closed but considered as net volume input (Kourafalou and Barbopoulos, 2003) through a river-like parameterization. At the bottom, a quadratic bottom drag coefficient has been used and the model uses vertical partial cells to fit the bottom depth shape. The nesting in the Atlantic Sea is provided by means of daily analysis and forecast CMEMS GLO-MFC (Global Ocean MFC) fields at $1/12^\circ$ horizontal resolution (the nesting approach is described in Oddo *et al.*, 2009).

The numerical solutions are corrected by a data assimilation scheme based on 3DVAR (Dobricic and Pinardi, 2008), recently modified (Pistoia *et al.*, 2017) to have grid point EOFs and a time dependent observational error evaluated according to Desroziers *et al.*, (2005). The assimilated data include: satellite Sea Level Anomaly (SLA) accounting for atmospheric pressure effect (from CMEMS Sea Level Thematic Assembly Center), and vertical temperature and salinity profiles from Argo, XBT and gliders (from CMEMS In situ Thematic Assembly Center). Objectively Analyzed Sea Surface Temperature (SST) fields (from CMEMS Ocean and Sea Ice Thematic Assembly Center) are used for the correction of surface heat fluxes using a relaxation constant of 40 [Wm⁻²K⁻¹].

3. MED-MFC physical modelling system form october 2017: EAS2

In October 2017 a new Med-MFC physical model will become operational, so-called EAS2, using the latest available NEMO model version 3.6 with non-linear free surface formulation and time-varying vertical z-star coordinates. The new model resolution is increased to $1/24^\circ$ uniform in the horizontal and 141 unevenly spaced vertical levels allowing to define the model as an eddy-resolving model for the Mediterranean Sea, since the first internal Rossby radius of deformation is around 10–15km in summer and for most of the Mediterranean subregional seas. The new vertical background viscosity and diffusivity values are set to $1.2\text{e-}6$ [m²/s] and $1.0\text{e-}7$ [m²/s] respectively (in EAS1 the values were set as: $1.2\text{e-}5$ and $1.2\text{e-}6$ [m²/s]), the horizontal bilaplacian eddy diffusivity and viscosity are set respectively equal to $-1.2\text{e}8$ [m⁴/s] and $-2.\text{e}8$ [m⁴/s] (in EAS1 the values were set as: $1.2\text{e-}6$ and $1.0\text{e-}7$ [m⁴/s]). No coupling with wave model is yet operational, it will be re-inserted in April 2018 (corresponding to the end of the 1st phase of the CMEMS service). The data assimilation system is modified with respect to EAS1 implementing the 3DVAR scheme developed by Storto *et al.*, (2015). The surface and open boundary forcing fields are not changed with respect to the previous system, while the freshwater inputs are increased from 7 to 39 river sources evaluated from monthly mean datasets. The new topography is created starting from the GEBCO 30arc-second grid (http://www.gebco.net/data_and_products/gridded_bathymetry_data/gebco_30_second_grid/), filtered and manually modified in critical areas such as: islands along the Eastern Adriatic coasts, Gibraltar and Messina straits, Atlantic box edge. Fig. 1 shows the model domain and topography as well as the location of the 39 rivers.

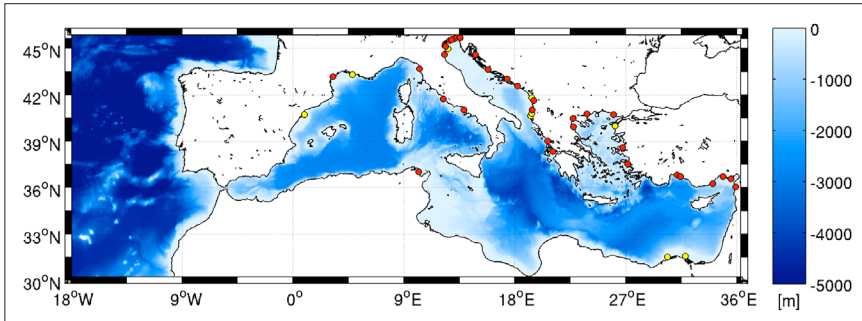

Fig. 1. Model domain, topography and location of river inputs: yellow dots represent the 7 river sources included in both EAS1 and EAS2, red dots represent the 32 additional rivers implemented in EAS2.

4. Model validation

The EAS2 system described in section 3 has been run starting from August 2013, initialized with temperature and salinity climatological fields from WOA13 V2 (World Ocean Atlas 2013 V2, <https://www.nodc.noaa.gov/OC5/woa13/woa13data.html>), up to present day in order to build a pre-operational dataset which has been validated using *in situ* and satellite observations. We will consider here intercomparison of EAS1 with EAS2 in the period 1st January 2015–31st December 2016. The EAS2 system described in section 3 has been run starting from August 2013, initialized with temperature and salinity climatological fields from WOA13 V2 (World Ocean Atlas 2013 V2, <https://www.nodc.noaa.gov/OC5/woa13/woa13data.html>), up to present day in order to build a pre-operational dataset which has been validated using *in situ* and satellite observations. We will consider here intercomparison of EAS1 with EAS2 in the period 1st January 2015–31st December 2016.

4.1 Validation datasets

Different datasets have been used to validate the numerical model results.

The first source of data consists of daily averages of *in situ* observations derived from a fixed coastal buoy network (<http://calval.bo.ingv.it/>) for temperature, salinity, sea level and currents. This provides an independent validation since moorings are not assimilated by the model. Quasi-independent validation is provided by evaluating temperature, salinity and SLA misfits calculated by the data assimilation system before data are ingested in the system. Moreover maps of numerical SST are compared to satellite daily gap-free SST-L4 maps at 1/160 resolution (Buongiorno Nardelli *et al.*, 2013) and comparison of the volume averaged temperature and salinity properties is done with available WOA13 V2 climatological data sets for the Mediterranean Sea.

4.2 Validation results

The results of the validation procedure are evaluated considering the years 2015-2016 for both the new upgraded system at 1/24° resolution (EAS2) and the previous system at 1/16° resolution (EAS1).

The model independent validation performed using coastal moorings is assessed by considering the Root Mean Square Difference (RMSD) of surface fields for: temperature, salinity, sea level and currents. Table I shows that the skill of the two systems in terms of temperature, salinity and currents is similar, while the new system is able to better predict the coastal sea level with a reduced error of about 0.7cm in 2015 and 0.3cm in 2016.

Table I. RMSD of Temperature, Salinity, Sea Level, Zonal and Meridional Currents for systems EAS1 and EAS2 compared to surface coastal mooring observations for the years 2015 and 2016. The number of available buoys used to validate the model solutions is also provided.

VARIABLE	YEAR 2015			YEAR 2016		
	N. BUOY	RMSD		N. BUOY	RMSD	
		EAS1	EAS2		EAS1	EAS2
Temperature [oC]	15	0.84	0.89	16	0.67	0.66
Salinity [PSU]	8	0.57	0.57	8	0.39	0.40
Sea Level [cm]	51	6.11	5.39	49	4.81	4.51
Zonal Vel. [cm/s]	5	12.85	11.72	6	11.35	12.13
Merid. Vel. [cm/s]	5	13.31	12.91	6	12.60	13.33

A check on the daily volume averaged salinity is provided by comparing the two systems with available WOA13 V2 datasets (used to initialize EAS2 system) and represented in Fig. 2 showing that the new system (blue line) is much closer to the climatological dataset (black dashed line) with respect to EAS1 (red line), also assessing the ability of the model to not diverge from its initial status.

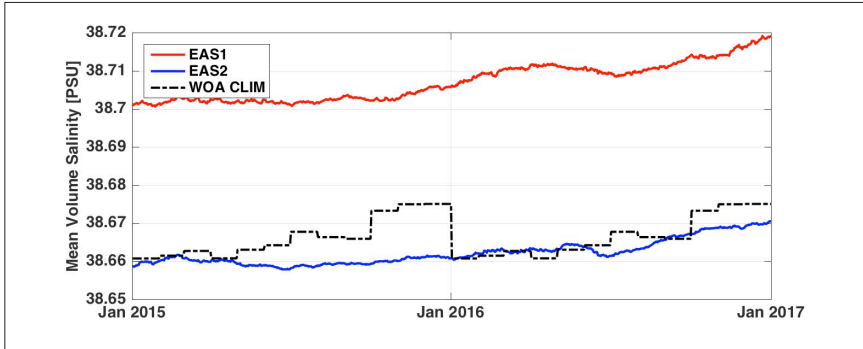

Fig. 2. Time series of daily volume averaged salinity evaluated for systems EAS1 (red line), EAS2 (blue line) and compared to monthly climatological values from WOA13 V2 datasets.

A quasi-independent validation assessment has been carried out by evaluating the RMS misfits in the open ocean: RMS of observation minus model value transformed at the observation location and time. Numerical temperature and salinity fields are compared to *in situ* datasets and SLA is compared to satellite observations. Results are presented in Table II for temperature and salinity at different depths showing that the new system always presents an enhanced skill with lower error with respect to the previous one, while it is characterized by a larger SLA error. This issue could be related to the updates in the data assimilation scheme and the need of a new estimate of the background error covariance matrix with Empirical Orthogonal Functions evaluated from a longer assimilation run.

Table II. RMS misfits of temperature and salinity at various depths for systems EAS1 and EAS2 averaged in the year 2015-2016.

DEPTH [M]	EAS1		EAS2	
	TEMP. RMS MISFIT [OC]	SAL. RMS MISFIT [PSU]	TEMP. RMS MISFIT [OC]	SAL. RMS MISFIT [PSU]
8	0.51	0.19	0.46	0.17
30	0.84	0.18	0.78	0.17
150	0.28	0.09	0.27	0.09
300	0.22	0.05	0.21	0.04
600	0.13	0.04	0.10	0.03
	SLA RMS MISFIT [CM]		SLA RMS MISFIT [CM]	
	3.31		4.22	

In order to assess the quality of the predicted SST, a comparison with satellite daily gap-free SST maps (L4) at $1/16^\circ$ horizontal resolution is presented in Fig. 3 showing maps of satellite SST averaged in the period 2015-2016 (left panel) and the difference between the predicted and observed SST for system EAS1 (central panel) and EAS2 (right panel). The numerical SST is in good agreement with the satellite data with maximum differences of $\pm 1^\circ\text{C}$ and showing a general slightly warmer pattern with respect to the Satellite data.

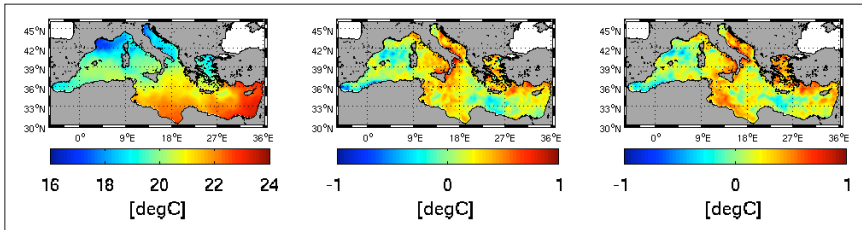

Fig. 3. SST Maps averaged in the period 2015-2016. Left: Satellite SST [degC]; Central: SST. Difference between EAS1 and Satellite [degC]; Right: SST. Difference between EAS2 and Satellite [degC].

5. Conclusions

A new numerical modeling system implemented in the Mediterranean Sea at 1/24° horizontal resolution and 141 vertical levels has been described and compared to the previous version at lower resolution (1/16° in the horizontal and 72 vertical levels). The differences between the two systems also include an update of the OGCM with a non-linear free surface formulation, z-star time varying vertical coordinates, an increased number of river inputs and an upgrade of the data assimilation scheme. A validation assessment performed for the years 2015-2016 has been carried out by comparing the new system, that will become operational from October 2017, with the previous one using *in situ*, satellite and climatological datasets. This study shows that the 2 numerical systems perform well in reproducing *in situ* as well as satellite measured physical parameters and are capable of representing most of the variability of the general circulation in the Mediterranean Sea. The new system presents an enhanced skill considering temperature and salinity model misfits along the entire water column, while some improvements should be carried out in the next future to enhance the representation of the SLA misfit using a new estimate of the background error covariance matrix for the SLA. The validation using independent coastal moorings shows similar performances between the two systems with an increased skill of the new system in predicting the sea level; moreover the overall model performance in coastal areas is lower with respect to open ocean and this issue will be considered in future improvements.

Acknowledgements

This work was supported by CMEMS Med-MFC (Copernicus Marine Environment Monitoring Service – Mediterranean Marine Forecasting Centre), Mercator Ocean Service.

References

- Adani, M., Dobricic, S. and Pinardi, N. (2011). Quality Assessment of a 1985–2007 Mediterranean Sea Reanalysis. *Journal of Atmospheric and Oceanic Technology*, 28, 569–589, doi: 10.1175/2010JTECHO798.1
- Buongiorno Nardelli, B., Tronconi, C., Pisano, A. and Santoleri, R. (2013). High and Ultra-High resolution processing of satellite Sea Surface Temperature data over Southern European Seas in the framework of MyOcean project. *Remote Sensing of Environment*, 129, 1-16.
- Clementi, E., Pistoia, J., Fratianni, C., Delrosso, D., Grandi, A., Drudi, M., Coppini, G., Lecci, R. and Pinardi, N. (2017a). Mediterranean Sea Analysis and Forecast (CMEMS MED-Currents 2013-2017). [Data set]. doi: https://doi.org/10.25423/MEDSEA_ANALYSIS_FORECAST_PHYS_006_001.

- Clementi, E., Oddo, P., Drudi, M., Pinardi, N., Korres, G. and Grandi A. (2017b). Coupling hydrodynamic and wave models: first step and sensitivity experiments in the Mediterranean Sea. *Ocean Dynamics*. doi: <https://doi.org/10.1007/s10236-017-1087-7>.
- Desroziers, G., Berre, L., Chapnik, B. and Poli, P. (2005). Diagnosis of observation, background and analysis-error statistics in observation space. *Quarterly Journal of the Royal Meteorological Society*, 131, 3385–3396.
- Dobricic, S. and Pinardi, N. (2008). An oceanographic three-dimensional variational data assimilation scheme. *Ocean Modelling*, 22, 3-4, 89-105.
- Kourafalou, V.H. and Barbopoulos, K. (2003). High resolution simulations on the North Aegean Sea seasonal circulation. *Annales Geophysicae*, 21, 251–265, doi: <http://www.ann-geophys.net/21/251/2003/>.
- Madec, G. (2008). NEMO ocean engine. *Note du Pole de modélisation, Institut Pierre-Simon Laplace (IPSL), France, Note 27*, ISSN 1288-1619, pp 209.
- Oddo, P., Adani, M., Pinardi, N., Fratianni, C., Tonani, M. and Pettenuzzo, D. (2009). A nested Atlantic-Mediterranean Sea general circulation model for operational forecasting. *Ocean Science*, 5, 461-47.
- Oddo, P., Bonaduce, A., Pinardi, N. and Guarnieri, A. (2014). Sensitivity of the Mediterranean sea level to atmospheric pressure and free surface elevation numerical formulation in NEMO. *Geoscientific Model Development*, 7, 3001-3015.
- Pettenuzzo, D., Large, W.G. and Pinardi, N. (2010). On the corrections of ERA-40 surface flux products consistent with the Mediterranean heat and water budgets and the connection between basin surface total heat flux and NAO. *Journal of Geophysical Research*, 115, C06022, doi: 10.1029/2009JC005631.
- Pinardi, N., Allen, I., Demirov, E., De Mey, P., Korres, G., Lascaratos, A., Le Traon, P.-Y., Maillard, C., Manzella, G. and Tziavos C. (2003). The Mediterranean ocean Forecasting System: first phase of implementation (1998-2001). *Annales Geophysicae*, 21, 3-20, doi:10.5194/angeo-21-3-2003.
- Pinardi, N. and Coppini, G. (2010). Operational oceanography in the Mediterranean Sea: the second stage of development. *Ocean Science*, 6, 263-267.
- Pistoia, J., Clementi, E., Delrosso, D., Mattia, G., Fratianni, C., Drudi, M., Grandi, A., Padeletti, D., Di Pietro, P., Storto, A. and Pinardi, N. (2017). Last improvements in the data assimilation scheme for the Mediterranean Analysis and Forecast system of the Copernicus Marine Service. *Extended abstract to the 8th EuroGOOS Conference, Bergen*.
- Simoncelli, S., Masina, S., Axell, L., Liu, Y., Salon, S., Cossarini, G., Bertino, et al. (2016). MyOcean regional reanalyses: overview of reanalyses systems and main results. *Mercator Ocean J. 54. Special Issue on Main Outcomes of the MyOcean2 and MyOcean Follow-on projects*. Available from: <https://www.mercator-ocean.fr/wp-content/uploads/2016/03/JournalMO-54.pdf>.

Storto, A., Masina, S. and Navarra, A. (2015). Evaluation of the CMCC eddy-permitting global ocean physical reanalysis system (C-GLORS, 1982-2012) and its assimilation components. *Quarterly Journal of the Royal Meteorological Society*, 142, 738–758, doi: 10.1002/qj.2673.

Tonani M., Teruzzi, A., Korres, G., Pinardi, N., Crise, A., Adani, M., Oddo, P., et al. (2014). The Mediterranean Monitoring and Forecasting Centre, a component of the MyOcean system. *Proceedings of the 6th International Conference on EuroGOOS*. Eurogoos Publication n°. 30, ISBN 978-91-974828-9-9



HIGH RESOLUTION OPERATIONAL ANALYSIS AND FORECASTS FOR THE MEDITERRANEAN SEA BIOGEOCHEMISTRY

S. Salon, G. Cossarini, P. Lazzari, A. Teruzzi, P. Di Cerbo, G. Bolzon, L. Feudale, C. Solidoro and A. Crise

OGS - Istituto Nazionale di Oceanografia e di Geofisica Sperimentale. ssalon@inogs.it.

Abstract

The CMEMS operational system for the analysis and forecast of the biogeochemical state of the Mediterranean Sea (MedBFM) has been upgraded increasing the spatial resolution to 1/24 degree and 125 vertical levels, redesigning its transport model with the free-surface formulation (z^* -coordinate) and revising the river inputs configuration. The implementation of the z^* -coordinate improves the mass budget concentration and the tracers dynamics at surface due to evaporation minus precipitation minus runoff process. To speed up the computational performance, the data assimilation module has been parallelized. The qualification of the new system version exploits different reference data showing that the accuracy of modelling products can be achieved from basin-wide and seasonal scale to mesoscale and weekly scale. In particular, the use of the BGC-Argo floats data allows for a relevant enhancement of the validation framework of operational biogeochemical models, providing new skill metrics for key biogeochemical processes and dynamics (e.g. deep chlorophyll maximum).

Keywords: operational oceanography, biogeochemistry, Mediterranean Sea, model validation

1. Introduction

Operational ocean forecasting systems integrate remote observations, in situ measurements and modelling systems, and have been widely recognized as important assets for growth in the blue economy (She *et al.*, 2016) and ocean state monitoring (von Schuckmann *et al.*, 2016). The European Copernicus Marine Environment Monitoring Service (CMEMS; marine.copernicus.eu) operationally provides “regular and systematic core reference information” on the state, variability and dynamics of the ocean, marine ecosystems and sea ice for the global ocean and the European regional seas. As user-driven service based on the “continuous improvement” philosophy, CMEMS is committed to maintain its operational systems up-to-date in order to supply quality-assessed products for the analysis of the current state of oceans and seas, for the short-term forecasts, and for the reanalysis and reprocessing of the recent decades.

Following such requirements, the system operated by the Mediterranean Sea Monitoring and Forecasting Centre (Med-MFC) has been recently subjected to a major upgrade, by increasing its horizontal resolution from 1/16 to 1/24 degree and almost doubling the number of vertical levels. The upgrade has involved different aspects of the forecasting system, including an improved alignment between the physical and the biogeochemical components. In the present contribution, we focus on the main outcomes of the work done to upgrade the biogeochemical component of Med-MFC (henceforth referred to as Med-BIO), discussing some details related to the z*-coordinate implementation, which concurs to improve the vertical processes, and to the new procedure to validate the products quality, which benefits from the BGC-Argo floats data. In the following, we briefly present the MedBFM system which is the core of the Med-BIO operational workflow, then in Section 2 we describe the z*-coordinate implementation for MedBFM, and in Section 3 the most interesting results of the Med-BIO products quality assessment procedure are shown. Conclusions are drawn in Section 4.

1.1 Description of the MedBFMv2.0 model system

The Med-BIO analysis and forecast products are provided by the MedBFMv2.0 model system, which is managed by OGS. MedBFMv2.0 consists of the coupled physical-biogeochemical OGSTM-BFM model and the 3DVARBIO assimilation scheme. OGSTM-BFM (Lazzari *et al.*, 2010) is designed with the OGSTM transport model, originally developed starting from the OPA 8.1 system (Foujols *et al.*, 2000), which resolves the advection, the horizontal and vertical diffusion and the sinking terms of the tracers (biogeochemical variables), and a biogeochemical reactor featuring the Biogeochemical Flux Model (BFM, see Lazzari *et al.*, 2012, 2016; Cossarini *et al.*, 2015, and references thereby), which describes the biogeochemical cycles of carbon and macro-nutrients (nitrogen, phosphorus and silicon) in terms of dynamical interactions among the dissolved inorganic, living organic and non-living organic compartments. 3DVARBIO is the variational data assimilation scheme for the correction of phytoplankton functional type variables using surface chlorophyll from satellite

observation (Teruzzi *et al.*, 2014), which in the upgraded version has been optimized with the parallelization of the data assimilation scheme, now active over both open sea and coastal areas. The upgraded meshgrid is based on $1/24^\circ$ longitudinal scale factor and on $1/24^\circ \cos(\varphi)$ latitudinal scale factor. The vertical meshgrid accounts for 125 vertical z-levels: 35 in the first 200m depth, 60 between 200 and 2000m, 30 below 2000m. MedBFMv2.0 features the non-linear free surface formulation (see Section 2) and includes the terrestrial inputs (e.g. nutrients, carbon, alkalinity) from 39 rivers (now aligned with Med-PHY, the physical component of Med-MFC) and the Dardanelles.

MedBFM uses as off-line physical forcing (current velocity, temperature, salinity, wind stress, shortwave radiation, eddy diffusivity, sea surface height) the outputs of the Med-PHY model system (based on NEMO3.6), to bi-weekly produce 7 days of analysis/hindcast and 10 days of forecast, assimilating the surface chlorophyll concentration from satellite observations (provided by the CMEMS-OCTAC). The initial conditions are set as sub-basin climatological profiles computed from in situ data collections described in Lazzari *et al.*, (2016) and Cossarini *et al.*, (2015). Boundary conditions at the Atlantic buffer west to Gibraltar Strait, Dardanelles, rivers and atmosphere deposition are mainly based on climatology or literature references. The products made available to CMEMS users are 3-D daily means of chlorophyll, net primary production, phytoplankton biomass, phosphate, nitrate, oxygen, pH, pCO₂. Further details can be found on the documents present in the CMEMS catalogue (Bolzon *et al.*, 2017).

2. OGSTM Transport model upgrade to z*-coordinate

To represent the non-linearity of the ocean free surface equation, the vertical coordinate is requested to be time-dependent (variable volume layer, “vvl”). The curvilinear z*-coordinate system approach is a rescaling of the usual z-coordinate (Adcroft and Campin, 2004) and represents the variable water column volume with a vertical coordinate that follows the time-dependent non-linear variation of the sea surface height (SSH). In this scheme, the sea-surface induced variation of the column thickness is distributed over the whole water column (i.e. along each vertical level) and not concentrated at the surface level as in the z-coordinate (i.e. at the surface layer), therefore the vertical levels follow the sea surface variations with a linear depth-attenuation (see Madec, 2016, for further details and the NEMO implementation).

To be fully consistent with the z*-coordinate NEMOv3.6 vvl outputs provided by Med-PHY, the OGSTM transport model of MedBFM has been upgraded to resolve the non-linear free surface formulation and time-varying vertical z*-coordinates effects on the transport of biogeochemical tracers. In particular, we included in OGSTM the computation of the time-dependent vertical scale (e_3) factor which takes in account the redistribution of the SSH (η), proportionally to the time-independent background vertical scale factor (e_3^0) $e_3 = e_3^0 [1 + \eta / H_0]$, where H_0 is the ocean depth. This modification makes necessary that the physical forcing driving the MedBFM, output of the Med-PHY model system,

includes the time-dependent 2-D field of SSH (daily means) throughout the 17 days of simulation. Further, vertical scale factors for both scalar and vector variables (i.e. T, U, V, W points) are computed as well, and the advection and diffusion operators have been modified to handle the new vertical scale factors.

With the above enhancement, OGSTM is now able to correctly preserve the mass budget of a tracer, while properly reproducing the concentration and dilution dynamics at surface due to the evaporation minus precipitation minus runoff process (E-P-R). A 1-year test simulation evaluated the difference between the mass budget (difference between final and initial total mass) and the time integral of input and exchanges at Gibraltar with a level of accuracy more than double with respect to the former rigid lid formulation. Then, the E-P-R effect on the tracers' concentrations at surface has been verified by the correct simulation of alkalinity, which is particularly sensitive to this process (Cossarini *et al.*, 2015), and whose seasonal cycle is characterized by an annual range of 30-50 $\mu\text{mol kg}^{-1}$ in the eastern Mediterranean Sea.

3. CMEMS Mediterranean Sea biogeochemistry product quality assessment

The MED-BIO analysis and forecast system has been validated through a qualification run spanning the period 2015 to 2016. The quality of the MedBFM model daily outputs has been assessed comparing the results with independent data (observational in situ datasets), semi-independent data (satellite datasets) and literature estimates, applying the GODAE-like metrics (see Hernandez *et al.*, 2015 for a recent review). A thorough description of the validation of several published variables is given in the CMEMS Quality Information Document (Cossarini *et al.*, 2017). Here we show the results of our validation which include the new data stream of BGC-Argo floats data: for chlorophyll, 28 BGC-Argo floats, mostly located in the western sub-basins, collected a total number of 2532 "adjusted-data" profiles for years 2015 and 2016 (Fig.1a). The Southern Ionian Sea and large part of the Levantine sub-basin were not monitored and a very small number of profiles were present in the Alboran Sea, South-western Mediterranean and Adriatic Sea.

Our goal is to evaluate the Med-BIO skill performance in reproducing the temporal evolution of the vertical dynamics of the phytoplankton in the Mediterranean Sea. Bias, root mean squared difference (RMSD), correlation and *ad hoc* new metrics between BGC-Argo profiles and the matching model output profiles (i.e. the model output at the time and location of the float profile, GODAE class 4 metric) were estimated as time series following a specific float trajectory (Fig.1b, c) and as average statistics computed from all the matching pairs of model and observation profiles for selected layers and sub-basins (Tab.I).

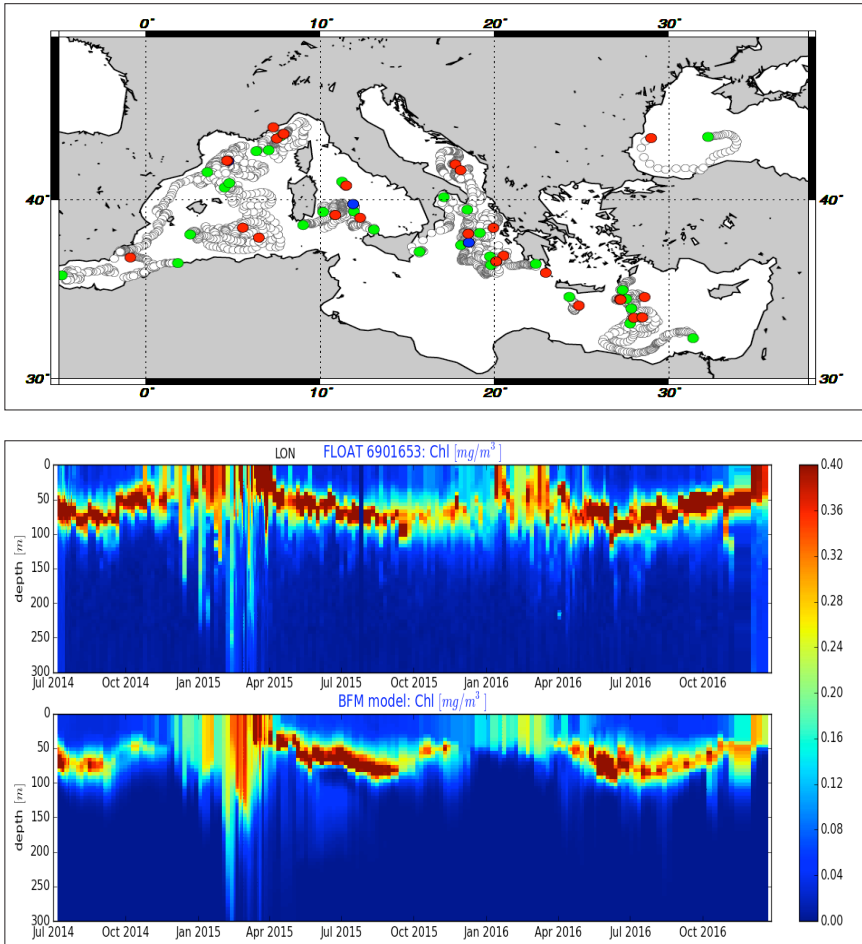

Fig. 1. Chlorophyll (Chl) adjusted data are derived by real time (RT) data with a series of corrections: the quenching correction, a re-calibration at depth and a tuning correction. The quenching correction (Xing et al., 2012) is performed by imposing a constant Chl value in the Mixed Layer Depth (flag 8). The re-calibration at depth is performed by imposing zero for Chl values below 600m (flag 2). The tuning correction (RT data divided by a factor of 2) is due to a detection of an error in the manufacturer calibration of Chl fluorometer (Roesler et al., 2017).

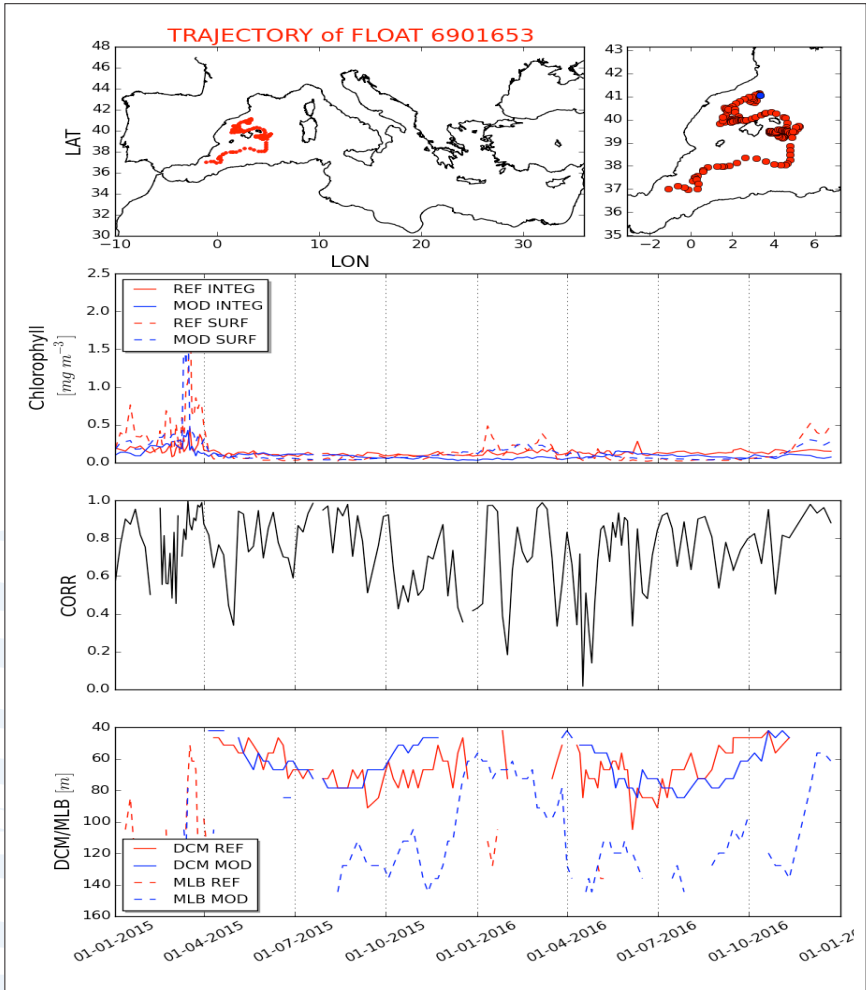

Fig. 2. a) Trajectories of the BGC-Argo floats during years 2015 and 2016; data from the UPMC-LOV web portal. b) Hovmöller diagram of chlorophyll for float 6901653 and the matched-up model output. c) Skill indexes for model (MOD, blue) and float data (REF, red) for the period Jan 2015 – Dec 2016: surface (SURF) and 0-200m vertically averaged (INTEG) chlorophyll, correlation (CORR), depth of the deep chlorophyll maximum (DCM, solid lines) and depth of the mixed layer bloom in winter (MLB, dashed lines). The trajectory of the BGC-Argo float n. 6901653 is reported in the upper panels (over the Mediterranean basin, left, and with a zoom over the area, right), with deployment position (blue).

The Hovmoller diagram of chlorophyll (Fig.1b) shows the very good qualitative agreement of the MedBFM model with the selected float in reproducing the temporal succession of the winter vertically mixed blooms, the onset and temporal dynamics of the deep chlorophyll maximum (DCM), and the depth of the DCM. The MedBFM chlorophyll quality for the selected float is analysed in more detail in Fig. 1c, where we show the time series of the new quantitative metrics computed on the vertical profiles comparison. There is a good agreement between model (blue) and float (red) at the surface and for the 0-200m vertical averaged chlorophyll values, with the model capable to reproduce the variability between the spring blooms in 2015 and 2016 (the former more intense than the latter). The time series of the correlation between profiles is almost always higher than 0.7, with higher values during summer period and lower values during winter, and the DCM is very well reproduced both in terms of vertical depth and temporal evolution. The depth of the mixed winter bloom (MLB, defined as the depth at which chlorophyll concentration is 10% of surface concentration during winter period) is not always computable from BGC-Argo float data, making this metric often not effective.

The chlorophyll metrics for different sub-basins, averaged over the period 2015-2016 (Tab.I), show that, with the exception of the Alboran Sea (very low data available, Tab.II), Bias is generally well below $0.1\text{mg}/\text{m}^3$, and uncertainty is evaluated with a RMSD below $0.15\text{ mg}/\text{m}^3$, with both metrics higher in the western sub-basins than in the eastern ones for the upper layers. Summer Bias and RMSD are negligible (not shown). As expected, higher values are observed for the layer 60-100 where high chlorophyll values are found in correspondence of the DCM, thus keeping the relative errors in line with the other layers. The metrics used to compare model outputs and BGC-Argo floats data (reported in the thematic regional validation webpage medeaf.inogs.it/nrt-validation) show that the model has stable performance as long as the number of available BGC-Argo floats remains constant.

Table I. Time averaged Bias and RMSD of chlorophyll (mg/m^3) for selected layers and aggregated sub-basins for the period Jan 2015 – Dec 2016. Statistics are computed using the match-ups of model with BGC-Argo float data.

	BIAS					RMSD				
	0-10 M	10-30 M	30-60 M	60-100 M	100-150 M	0-10 M	10-30 M	30-60 M	60-100 M	100-150 M
Alboran Sea	0.29	0.29	0.23	0.10	0.02	0.39	0.37	0.27	0.14	0.05
SWMed	-0.04	-0.04	-0.06	-0.03	-0.02	0.09	0.09	0.15	0.12	0.04
NWMed	-0.05	-0.05	-0.07	-0.07	-0.02	0.13	0.13	0.14	0.14	0.06
Tyrrhenian Sea	-0.04	-0.04	-0.06	-0.09	-0.04	0.06	0.06	0.09	0.12	0.06
Adriatic Sea	0.01	0	-0.04	-0.15	-0.04	0.04	0.04	0.08	0.15	0.04
Ionian Sea	-0.02	-0.03	-0.04	-0.05	-0.06	0.05	0.06	0.06	0.08	0.07
Levantine basin	-0.02	-0.02	-0.03	-0.07	-0.06	0.05	0.05	0.05	0.10	0.08

As shown in Fig. 1, the use of the BGC-Argo float data available for the investigated period potentially strengthens the accuracy of the Med-BIO chlorophyll product and corroborates its consistency in reproducing the key mechanisms coupling physics and biogeochemistry at mesoscale and along the vertical dimension. To quantify the model basin-scale skill to reproduce these key properties we extended the 3 metrics proposed in Fig. 1c (averaged content of chlorophyll in the photic layer 0-200m, depth of DCM and depth of the winter mixed bloom, MLB) to the entire available data set (Tab.II).

Table II. Time averaged chlorophyll indicators based on the BGC-Argo floats and model comparison for the period Jan 2015 – Dec 2016.

	CORR	AVERAGE 0-200M [MG/M ³]		DCM [M]		MLB [M]		AVERAGE NUMBER OF AVAILABLE PROFILES PER MONTH
		BIAS	RMSD	BIAS	RMSD	BIAS	RMSD	
Alboran Sea	0.80	0.05	0.10	-20	20	-4	51	2
SWMed	0.79	-0.05	0.07	4	11	n.a.	n.a.	9
NWMed	0.76	-0.06	0.09	-6	12	4	51	22
Tyrrhenian Sea	0.80	-0.05	0.07	0	11	-11	19	14
Adriatic Sea	0.66	-0.05	0.05	-7	18	n.a.	n.a.	7
Ionian Sea	0.80	-0.04	0.05	-3	25	-22	48	25
Levantine basin	0.79	-0.05	0.06	-6	15	n.a.	n.a.	27

The averaged vertical values show that the correlation between vertical profiles of model and floats is up to 0.8. In the areas with at least 7 float profiles per month, the modelled averaged content of chlorophyll in the photic layer has a Bias lower than -0.06 mg/m^3 and a RMSD lower than 0.09 mg/m^3 , the DCM depth is reproduced with an uncertainty range of 11-25m and a maximum absolute Bias of -7m, while MLB has a Bias range of -22 to 4m and an uncertainty of 20-50m. The model generally underestimates the content of chlorophyll with respect to the float measurements, though recent analysis of BGC-Argo float data might suggest that chlorophyll values should need to be recalibrated (Mignot *et al.*, 2017). The resulting absolute uncertainty of the DCM depth, generally 10-20m, is a very promising outcome considering that the vertical discretization is 5-10m for the layers around 80-120m depth. Though values of MLB are not computable and reliable for many sub-basins, our results show that also the winter mixing and the consequent driven phytoplankton bloom are quite well reproduced both qualitatively and quantitatively.

4. Conclusions

A new version of the CMEMS Med-BIO is operational since autumn 2017 featuring a free-surface formulation for transport, higher spatial resolution and full consistency with the physical component of the Med-MFC system. The new Med-BIO system allows for high accuracy in mass conservation, with tracer concentrations at surface properly driven by E-P-R process.

Classical skill metrics based on satellite data, *in situ* observations and climatology confirmed the good performance of the new Med-BIO system, whereas the novel BGC-Argo float data empowered us to design new metrics showing the capability of the MedBFM model to reproduce the temporal evolution of the vertical dynamics of the phytoplankton and key ecosystem processes in the Mediterranean Sea. The novel metrics based on BGC-Argo data disclose new and important perspectives for the model validation in the Mediterranean Sea, also considering its very high spatial heterogeneity and the seasonal variability of the coupled physical-biogeochemical processes. However, some cautions should be taken before generalizing the conclusions, since the relatively poor BGC-Argo floats coverage in some areas and the on-going improvement of product quality procedures of the BGC-Argo data.

Acknowledgements

This study has been conducted using E.U. Copernicus Marine Service Information.

References

- Adcroft, A. and Campin, J.-M. (2004). Re-scaled height coordinates for accurate representation of free-surface flows in ocean circulation models. *Ocean Modelling*, 7, 269–284, doi:10.1016/j.ocemod.2003.09.003, <http://dx.doi.org/10.1016/j.ocemod.2003.09.003>.
- Bolzon G., Cossarini G., Lazzari P., Salon S., Teruzzi A., Crise A., Solidoro C. (2017). Mediterranean Sea biogeochemical analysis and forecast (CMEMS MED AF-Biogeochemistry 2013-2017). [Data Set] Copernicus Monitoring Environment Marine Service. doi: https://doi.org/10.25423/MEDSEA_ANALYSIS_FORECAST_BIO_006_006
- Cossarini G., Lazzari P., Solidoro, C. (2015). Spatiotemporal variability of alkalinity in the Mediterranean Sea. *Biogeosciences*, 12(6), 1647-1658.
- Cossarini G., Salon, S., Bolzon, G., Teruzzi, A., Lazzari, P., Feudale, L. (2017). Quality Information Document for MEDSEA_ANALYSIS_FORECAST_BIO_006_014, Copernicus Monitoring Environment Marine Service, in preparation.
- Foujols, M.-A., Lévy, M., Aumont, O., Madec, G. (2000). OPA 8.1 Tracer Model Reference Manual. Institut Pierre Simon Laplace, pp. 39.
- Hernandez, F., Blockley, E., Brassington, G.B, Davidson, F., Divakaran, P., Drévillon, M., Ishizaki, S., Garcia-Sotillo, M., and other 17 co-authors (2015). Recent progress

in performance evaluations and near real-time assessment of operational ocean products, *Journal of Operational Oceanography*, 8(2), 221-238, DOI:10.1080/1755876X.2015.1050282

Lazzari P., Teruzzi A., Salon S., Campagna S., Calonaci C., Colella S., Tonani M., Crise A. (2010). Pre-operational short-term forecasts for the Mediterranean Sea biogeochemistry. *Ocean Science*, 6, 25-39.

Lazzari, P., Solidoro, C., Ibello, V., Salon, S., Teruzzi, A., Béranger, K., Colella, S., and Crise, A. (2012). Seasonal and inter-annual variability of plankton chlorophyll and primary production in the Mediterranean Sea: a modelling approach. *Biogeosciences*, 9, 217-233.

Lazzari, P., Solidoro, C., Salon, S., Bolzon, G. (2016). Spatial variability of phosphate and nitrate in the Mediterranean Sea: a modelling approach. *Deep Sea Research I*, 108, 39-52.

Madec, G., 2016. NEMO ocean engine (v3.6). Note du Pôle de modélisation de l'Institut Pierre-Simon Laplace (IPSL), France, N° 27, ISSN No 1288-1619.

Mignot A., D'Ortenzio, F., Taillandier, V., Cossarini, G., Salon, S., Mariotti, L. (2017). Estimation of BGC-Argo chlorophyll fluorescence and nitrate observational errors using the triple collocation method. 6th Euro-Argo Users Meeting July 4-5, 2017 in Paris, France.

Roesler, C., Uitz, J., Claustre, H., Boss, E., Xing, X., Organelli, E., Briggs, N., Bricaud, A., Schmechtig, C., Poteau, A., D'Ortenzio, F., Ras, J., Drapeau, S., Haëntjens, N. and Barbieux, M. (2017). Recommendations for obtaining unbiased chlorophyll estimates from *in situ* chlorophyll fluorometers: A global analysis of WET Labs ECO sensors. *Limnol. Oceanogr. Methods*, 15: 572–585. doi:10.1002/lom3.10185

She, J., Allen, I., Buch, E., Crise, A., Johannessen, J. A., Le Traon, P.-Y., Lips, U., Nolan, G., and other 5 co-authors (2016). Developing European operational oceanography for Blue Growth, climate change adaptation and mitigation, and ecosystem-based management, *Ocean Science*, 12, 953-976, <https://doi.org/10.5194/os-12-953-2016>.

Teruzzi A., Dobricic S., Solidoro C., Cossarini G. (2014). A 3D variational assimilation scheme in coupled transport biogeochemical models: Forecast of Mediterranean biogeochemical properties, *Journal of Geophysical Research*, doi:10.1002/2013JC009277.

von Schuckmann, K., Le Traon, P.-Y., Alvarez-Fanjul, E., Axell, L., Balmaseda, M., Breivik, L.-A., Brewin, R.J.W., Bricaud, C., and other 70 co-authors (2016). The Copernicus Marine Environment Monitoring Service Ocean State Report. *Journal of Operational Oceanography*, 9, 235-320.

Xing, X., Morel, A., Claustre, H., Antoine, D., D'Ortenzio, F., Poteau, A. (2012). Combined processing and mutual interpretation of radiometry and fluorometry from autonomous profiling Bio-Argo floats: 2. Colored dissolved organic matter absorption retrieval. *Journal of Geophysical Research* 117, C04022.

MODELING IN THE MEDITERRANEAN SEA: THE MONGOOS CONTRIBUTION

G. Umgiesser^(1,2), P. Garreau⁽³⁾, A. S. Arcilla⁽⁴⁾, E. Clementi⁽⁵⁾, S. Salon⁽⁶⁾, M. Ravdas⁽⁷⁾, I. Federico⁽⁸⁾, G. Zodiatis⁽⁹⁾, C. Ferrarin⁽¹⁾, G. Verri⁽⁸⁾, G. Cossarini⁽⁶⁾, M. G. Sotillo⁽¹⁰⁾, A. Cucco⁽¹¹⁾, R. Sorgente⁽¹¹⁾, B. Mourre⁽¹²⁾, I. Vilibic⁽¹³⁾, S. Sammartino⁽¹⁴⁾, G. Coppini⁽⁸⁾ and E. A. Fanjul⁽¹⁰⁾

⁽¹⁾ ISMAR-CNR, Institute of Marine Sciences, Venezia, Italy

⁽²⁾ Klaipeda University, Klaipeda, Lithuania

⁽³⁾ IFREMER, Brest, France

⁽⁴⁾ Maritime Engineering Laboratory (LIM), Polytechnic University of Catalunya (UPC), Barcelona, Spain

⁽⁵⁾ INGV, Istituto Nazionale di Geofisica e Vulcanologia, Bologna, Italy

⁽⁶⁾ OGS, Istituto Nazionale di Oceanografia e di Geofisica Sperimentale, Trieste, Italy

⁽⁷⁾ HCMR, Anavyssos Attiki, Greece

⁽⁸⁾ CMCC, Euro-Mediterranean Center on Climate Change, Lecce, Italy

⁽⁹⁾ Oceanography Center, University of Cyprus, Cyprus

⁽¹⁰⁾ Puertos del Estado, Madrid, Spain

⁽¹¹⁾ IAMC-CNR, TorreGrande, Loc. Sa Mardini 09170, Oristano, Italy

⁽¹²⁾ Coastal Ocean Observing and Forecast System (SOCIB), Palma de Mallorca, Balearic Islands, Spain

⁽¹³⁾ Institute of Oceanography and Fisheries, Split, Croatia

⁽¹⁴⁾ University of Málaga, Málaga, Spain

Abstract

In the past years, the MonGOOS modeling community has developed an important expertise in the application and development of numerical models to the Mediterranean Basin. The applications cover both operational systems and process modeling, in the whole or in part of the Mediterranean. The present contribution pretends highlight the main successes and challenges derived from this MonGOOS activity.

Keywords: MonGOOS, Mediterranean, Operational Oceanography, process modeling

1. Introduction

Operational forecasting models show a wide spectrum of application areas and parameters predicted. Specific areas where the models are applied range from Spain, via the Italian peninsula, Cyprus to the Israeli coast. Basin wide scales as well as regional and sub-regional scales are resolved. Most of the forecast models use Copernicus Marine Environment Monitoring Services (CMEMS) products that are then downscaled to the desired resolution and the chosen area. Quantities modeled are currents, levels and waves, as well as biogeochemical ones. An active field of research is the simulation of meteorological tsunamis that can lead to high flooding in otherwise less vulnerable parts of the Mediterranean Sea.

The improvement of resolution from open sea models is a common need of operational systems and process oriented implementations. Some of the models apply nesting techniques to zoom to the desired resolution; others use unstructured meshes such as finite elements that allow a flexible increase in resolution. Whereas the finite elements describe by default two-way interactions, with nesting the two-way interaction is more difficult to obtain. In both cases some of the sub-grid parameterizations have been or need to be reviewed.

Even if the Mediterranean is a micro-tidal basin, the effects of tides can be important. This is especially true in areas of relative high tides (North-Adriatic Sea) and of important tidal currents, such as in the Messina and Gibraltar Straits. Here the focus is on the description of the interaction of the open sea with the coastal zone. This interaction is bi-directional, where the small-scale features can also influence the open sea.

One of the major MonGOOS community project in recent years was the “Mediterranean Decision Support System for Marine Safety” (www.medess4ms.eu), dedicated to the maritime risks prevention and strengthening of maritime safety related to oil spill pollution in the Mediterranean. MEDESS-4MS main objective was the implementation of an integrated multi-model oil spill prediction system for the entire Mediterranean connected to existing monitoring platforms (EMSA-CSN and REMPEC), using well-established oil spill modeling systems and met-ocean data from the Copernicus services and the member states ocean forecasting systems. The majority of the MonGOOS forecasting systems, a total of 28 from 9 Mediterranean EU countries (14 hydrodynamic, 7 wave and 7 atmospheric forecasting models), were homogenized in terms of their input/output data format, common data exchange protocols, file naming specifications, archiving, etc., in order to suit the well-established oil spill models of MEDSLIK, MOTHY, POSEIDON, MEDSLIK-II in any part of the Mediterranean (Zodiatis *et al.*, 2016). The MonGOOS community of the MEDESS4MS project has set, for the first time ever in cooperation with REMPEC the guidelines for the integration of the multi parametric forecasting systems with operational oil spill models, following the EMSA-CSN relevant requirements.

This presentation of the ongoing studies and operational activities is far from being comprehensive, and is based on a MonGOOS workshop held on the 15th November 2016 in Split. There will certainly be other operational systems present in the Mediterranean and the fact that they are not mentioned here does by no way imply any preference nor does it give any value to the systems.

The reader will find an extensive information of numerical forecasts available in the framework of MonGOOS on the website : http://www.mongoos.eu/in_situ-and-forecasts.

2. Operational oceanography in the Mediterranean under MonGOOS

Most of the forecast systems presented in the MonGOOS community either are CMEMS products or use CMEMS products that are then downscaled to the various desired solutions. The CMEMS Mediterranean Sea Monitoring and Forecasting Centre (Med-MFC) is operationally providing physical, biogeochemical and wave numerical parameters for the whole Mediterranean Sea that are freely available through the CMEMS Catalogue (<http://marine.copernicus.eu>). Specifically, the CMEMS Med-Currents operational system is concentrating on the description of the main physical parameters as currents, tracers and sea level inside the whole Mediterranean basin (Clementi *et al.*, 2017). It uses NEMO with a resolution of $1/16^\circ$ with 72 z-levels, it is coupled with a wave model (WaveWatch3) providing the neutral drag coefficient and assimilates satellite Sea Level Anomaly and vertical temperature and salinity profiles from Argo, XBT and gliders.

Coupled offline with the abovementioned one at the same resolution and domain, the CMEMS-Med-Biogeochemistry operational system features the BFM biogeochemical model (Lazzari *et al.*, 2012) and the 3DVAR variational assimilation of surface chlorophyll (Teruzzi *et al.*, 2014). CMEMS-Med-Biogeochemistry provides daily fields of water quality parameters (i.e., nutrients, dissolved oxygen, primary production and phytoplankton biomass) and essential climate variables (i.e., pH and pCO₂; Bolzon *et al.*, 2017).

Finally, the wave-forecasting component of the Med-MFC is applying a wave model on the whole Mediterranean with a resolution of $1/24$ of a degree, based on the WAM model (Cycle 4.5.4) (Günther and Behrens, 2012). This model receives its boundary condition from a similar model applied to the Atlantic ($1/6$ resolution). It uses off-line current information for the current-wave interaction and in its final version the model will assimilate observations to produce a wave analysis product.

Downscaling of CMEMS products are successfully carried out at sub-regional scale for the Western Mediterranean sub-basins, throughout the implementation of POM

based operational systems namely TSCRM (Sorgente *et al.*, 2016) and WMED (Olita *et al.*, 2013). Both models provide daily forecast of the main ocean variables that are also used as boundary conditions for implementation of coastal ocean models applications (Cucco *et al.*, 2012), as input data for MEDSLIK simulations (Sorgente *et al.*, 2016) and for trajectories prediction of floating objects (Di Maio *et al.*, 2016).

What concerns models that focus on smaller areas, such as in the Spanish SAMOA project of Puertos del Estado, the downscaled CMEMS products (in this case, using also its regional Atlantic CMEMS IBI products) are used for assessing parameters (waves, currents, sea level) in the Spanish harbors. The ROMS model is used to reach high resolution and new processes in harbor areas.

Downscaling of CMEMS Med-MFC have been performed in the coastal waters of Southern-eastern of Italy, with a special focus on the Apulia region, through SANIFS (Federico *et al.*, 2017) forecasting system, based on three-dimensional hydrodynamic SHYFEM model and implemented at sub-regional (3km res.), coastal (100m res.) and harbor scale (20m res.).

SANIFS (Southern Adriatic Northern Ionian coastal Forecasting System) is a coastal-ocean operational system based on the unstructured grid finite-element three-dimensional hydrodynamic SHYFEM model, providing short-term forecasts. The operational chain is based on a downscaling approach starting from the large-scale system for the entire Mediterranean Basin (MFS, Mediterranean Forecasting System), which provides initial and boundary condition fields to the nested system.

In Cyprus, the CYCOFOS forecasting system at regional and sub-regional scales provides a) high resolution flow forecasts in the entire Eastern Mediterranean at 2km resolution, as well as in the EEZ of Cyprus at 1km resolution, b) wave forecasts in the Mediterranean and the Black Sea at 5km resolution and c) forecast of the surface forcing using the WRF model at the same domain and resolution as the SKIRON, for back up purposes (Zodiatis *et al.*, 2015; 2016). Modeled parameters are hydrodynamic, atmospheric and waves. A complex nesting procedure allows CYCOFOS the downscaling of CMEMS products to a resolution of ½km in the Levantine basin. The CYCOFOS products used by the MEDSLIK model for operational oil spill predictions.

In front of the Israel coast the forecasting system SELIPS has been implemented. It is nested into ALERMO, and atmospheric forcing is taken from SKIRON. The model is a modified POM model and the resolution is about 1km with 27 sigma levels. Outputs produced are hydrodynamic parameters that can also be used for MEDSLIK simulations. The Balearic Rissaga Forecasting System is a highly specialized system that tries to predict resonant meteo-tsunami that might form in the Ciutadella harbor. This system can then be used for early warning systems against predicted flooding.

Finally, the Kassandra system is simulating the storm surge impact in the whole Mediterranean Sea, with a focus on the Italian coast, where a resolution of less than 1km can be achieved due to the flexible finite element grid. Forecasted parameters are total water level and wave parameters, with a wave-current interaction implemented (Ferrarin *et al.*, 2013).

3. Process studies in the Mediterranean under MonGOOS

Some of the MonGOOS process studies are dealing with tides. Even if tides are normally not very relevant in the Mediterranean Sea, locally they might be important such as in the Messina Strait and in the Northern Adriatic Sea. Two applications are shown, where in both cases the unstructured model SHYFEM (Umgiesser *et al.*, 2004) has been used for downscaling to the desired resolution. In the Messina Strait the tidal currents and the complex vertical advection has been successfully modeled (Cucco *et al.*, 2016). The sensitivity of the solution depending on tides, thermohaline and atmospheric forcing has been investigated. In the other application, the influence of lagoons on the far field circulation has been studied. It is shown that neglecting and considering the feedback of the lagoons, the tidal amplitude in the center of the Adriatic Sea can change by some centimeters, a fact that should be considered when applying tidal models to marginal seas (Ferrarin *et al.*, 2017).

Circulation modeling with a focus on the water exchange in inlets and estuaries is explored in other applications. One is the case of the riverine freshwater release, which is found to strongly affect both the coastal and basin wide overturning circulation and dynamics (Verri *et al.*, 2017). Thus the regional ocean modeling needs a reliable representation of the non-zero salinity outflows at river outlets; the coupling with a diagnostic estuarine box model has been proposed and applied to the Ofanto river outlet as first case study. Another one is the circulation in harbor domains which shows similar estuarine patterns with important horizontal and vertical segregation.

Regional atmospheric models outperform the other applications where climatological data was used. In the Algeciras Bay (Strait of Gibraltar), the high-resolution surface dynamics has been modeled using a Lagrangian particle tracking system. The SAMPAv2 model is used with a double regional-to-local nested model to achieve an increase of resolution from 6400 meters to down to 30 meters inside the harbor. Lagrangian modeling is then used to assess water quality renewal efficiency. In the same area, the SAMPA model is also used to model the Atlantic water intrusion in the Mediterranean Sea, both through Lagrangian and Eulerian methods. A validation of these local PdE SAMPA products, together with the regional CMEMS IBI ones was also achieved through the release of buoys and ad hoc measurement campaigns (for instance in the context of the previously cited MEDESS-4MS Project; Sotillo *et al.*, 2016).

In the North-Western Mediterranean Sea, along the French coast, a two-way zoom model has been applied, resolving the regional circulation close to the coast with a resolution from kilometer until 100 meters (Garnier *et al.*, 2014; Herbert *et al.*, 2014). This configuration has been also used for different research, process studies or numerical improvement (e.g., anchovy recruitment, biochemistry, impact of heat waves on red gorgonian, contourites along the continental slopes, impact on sub-mesoscales processes on convection, spectral nudging etc.).

In the CMEMS Med-MFC-Biogeochemistry forecast model a new assimilation scheme is currently being developed to integrate BGC-Argo floats data with ocean color satellite data into the operational model. A 3D variational assimilation scheme (3DVARBIO) uses chlorophyll concentrations available from the two platforms, background error covariance decomposition and relative observation errors to correct the dynamics of the phytoplankton and biogeochemical components on a daily basis.

Finally, an active area of research is the field of meteo-tsunamis. Applications to areas in Mallorca and the Croatian islands are shown and the importance of these local processes is highlighted. It is especially important to consider a very high resolution of the models and the quality of meteorological forecasts. One application is the COAWST model, where WRF, ROMS and SWAN are combined to predict the effects of these meteo-tsunamis. The bathymetry is identified as one of the bottlenecks for reliable forecasts. In the case of the Ciutadella harbor in the Balears, synthetic forcing of atmospheric parameters is used to get a better insight in the physical processes governing the phenomenon.

4. Conclusions

In this article, we present the activities of the MonGOOS community dealing with operational modelling and process based studies. These activities are on the core of the MonGOOS group and the article show the extreme bandwidth of applications that are being developed and maintained. The meeting in Split was a way to maintain the necessary bridge between operational constrains and a more academic research. This community has already shared some common projects (MEDESS-4MS, Zodiatis *et al.*, 2016). In the future, it would be important to attract even more contributions from the Mediterranean modelling community in order to establish a firm working group that could then take the lead in model development and project participations.

Acknowledgements

The authors would like to thank the MonGOOS organization for being able to present and discuss the model application in its framework and be able to use the provided infrastructure for future development.

References

- Bolzon G., Cossarini G., Lazzari P., Salon S., Teruzzi A., Crise A., Solidoro C. (2017). "Mediterranean Sea biogeochemical analysis and forecast (CMEMS MED AF-Biogeochemistry 2013-2017)". [Data set]. *Copernicus Monitoring Environment Marine Service*.
- Cucco, A., Quattrocchi G., Olita, A., Fazioli, L., Ribotti, A., Sinerchia, M., Tedesco, C., and Sorgente, R., (2016). Hydrodynamic modelling of coastal seas: the role of tidal dynamics in the Messina Strait, Western Mediterranean Sea. *Nat. Hazards Earth Syst. Sci.*, 16, 1553–1569.
- Cucco A., M. Sinerchia, A. Ribotti, A. Olita, L. Fazioli, A. Perilli, B. Sorgente, M. Borghini, K Schroeder and R. Sorgente (2012). A high-resolution real-time forecasting system for predicting the fate of oil spills in the Strait of Bonifacio (western Mediterranean Sea). *Marine Pollution Bulletin*, Vol. 64, Iss. 6, pp. 1186-200.
- Clementi, E., Pistoia, J., Fratianni, C., Delrosso, D., Grandi, A., Drudi, M., Coppini, G., Lecci, R., Pinardi, N. (2017). Mediterranean Sea Analysis and Forecast (CMEMS MED-Currents 2013-2017). [Data set]. *Copernicus Monitoring Environment Marine Service (CMEMS)*.
- Di Maio A., M. V. Martin and R. Sorgente (2016). Evaluation of the Search and Rescue Leeway model into the Tyrrhenian sea: a new point of view, *Natural Hazards and Earth System Sciences*, Vol.16, Iss. 8, pp. 1979-1997.
- Federico I., Pinardi N., Coppini G., Oddo P., Lecci R., and Mossa M. (2017), Coastal ocean forecasting with an unstructured grid model in the southern Adriatic and northern Ionian seas, *Nat. Hazards Earth Syst. Sci.*, Vol. 17, 45-59.
- Ferrarin C., Maicu F., Umgiesser G. (2017). The effect of lagoons on Adriatic Sea tidal dynamics. *Ocean Modelling* (submitted).
- Ferrarin, C., Roland, A., Bajo, M., Umgiesser, G., Cucco, A., Davolio, S., Buzzi, A., Malguzzi, P. and Drofa, O. (2013). Tide-surge-wave modelling and forecasting in the Mediterranean Sea with focus on the Italian coast. *Ocean Modelling*, Vol. 61, 38-48.
- Garnier V., Pairaud I., Nicolle A., Alekseenko E., Baklouti M., Thouvenin B., Lecornu F., Garreau P. (2014). MENOR: a high-resolution (1.2km) modeling of the North-Western Mediterranean Sea routinely run by the PREVIMER operational forecast system. *Mercator Ocean - Quaterly Newsletter*, 49, 69-75.
- Günther, H., Behrens, A., (2012). The WAM model. Validation document Version 4.5.4. Intitute of Coastal Research Helmholtz-Zentrum Geesthach (HZG).

Herbert G., Garreau P., Garnier V., Dumas F., Caillaud S., Chanut J., Levier B., Aznar R. (2014). Downscaling from Oceanic Global Circulation Model towards Regional and Coastal Model using spectral nudging techniques: application to the Mediterranean Sea and IBI area models. *Mercator Ocean - Quarterly Newsletter*, 49, 44-59.

Lazzari, P., Solidoro, C., Ibello, V., Salon, S., Teruzzi, A., Béranger, K., Colella, S., and Crise, A., (2012). Seasonal and inter-annual variability of plankton chlorophyll and primary production in the Mediterranean Sea: a modelling approach. *Biogeosciences*, 9, 217-233.

Olita, A. Ribotti, L. Fazioli, A. Perilli and R. Sorgente (2013). Surface circulation and upwelling in the Sardinia Sea: A numerical study. *Continental Shelf Research*, Vol. 71, pp. 95-108.

Sorgente R., C. Tedesco, F. Pessini, M. De Dominicis, R. Gerin, A. Olita, L. Fazioli, A. Di Maio and A. Ribotti (2016). Forecast of drifter trajectories using a Rapid Environmental Assessment based on CTD observations. *Deep-Sea Research Part II: Topical Studies in Oceanography*, Vol. 133, pp. 39-53.

Sotillo MG, A Amo-Baladrón, E Padorno, E Garcia-Ladona, A Orfila, P Rodríguez-Rubio, D Conti, JA Jiménez Madrid, F J de los Santos, E Alvarez Fanjul. (2016). How is the surface Atlantic water inflow through the Gibraltar Strait forecasted? A lagrangian validation of operational oceanographic services in the Alboran Sea and the Western Mediterranean. *Deep Sea Research II: Topical Studies in Oceanography*. Vol 133. pp 100-117.

Teruzzi A., Dobricic S., Solidoro C., Cossarini G. (2014). A 3D variational assimilation scheme in coupled transport biogeochemical models: Forecast of Mediterranean biogeochemical properties, *Journal of Geophysical Research*, 119(1), 200–217.

Umgiesser, G., Melaku Canu, D, Cucco, A. and Solidoro, C. (2004). A finite element model for the Venice Lagoon. Development, set up, calibration and validation. *Journal of Marine Systems*, Vol. 51, 123-145.

Verri, G., Pinardi, N., Oddo, P., Ciliberti, S.A., Coppini, G., 2017. River runoff influences on the Central Mediterranean Overturning Circulation. *Climate Dynamics* 1-29 DOI: 10.1007/s00382-017-3715-9

Zodiatis, G., Galanis G., Kallos G., Nikolaidis A., Kalogeri C., Liakatas A. and Stylianou S. (2015). The impact of sea surface currents in wave power potential modeling. *Ocean Dynamics*, 65:1547.

Zodiatis G., M. De Dominicis, L. Perivoliotis, H. Radhakrishnan, E. Georgoudis, M.

Sotillo, R.W. Lardner, G. Krokos, D. Bruciaferri, E. Clementi, A. Guarnieri, A. Ribotti, A. Drago, E. Bourma, E. Padorno, P. Daniel, G. Gonzalez, C. Chazot, V. Gouriou, X. Kremer, S. Sofianos, J. Tintore, P. Garreau, N. Pinardi, G. Coppini, R. Lecci, A. Pisano, R. Sorgente, L. Fazioli, D. Soloviev, S. Stylianou, A. Nikolaidis, X. Panayidou, A. Karaolia,

A. Gauci, A. Marcati, L. Caiazza, M. Mancini, The Mediterranean Decision Support System for Marine Safety dedicated to oil slicks predictions, (2016). *Deep Sea Research Part II: Topical Studies in Oceanography*, Volume 133, 4-20.

Zodiatis, G., Radhakrishnan H., Galanis G., Nikolaidis A., Emmanouil G., Nikolaidis G., Lardner R., Sofianos S., Stylianou S. and Nikolaidis M. (2016). The CYCOFOS new forecasting systems at regional and sub-regional scales for supporting the marine safety. *Geophysical Research Abstracts*, Vol. 18, EGU2016-13807, EGU General Assembly, Vienna, 17 – 22 April.

DOWNSCALING THE COPERNICUS CMEMS MED-MFC IN THE EASTERN MEDITERRANEAN: THE NEW CYCOFOS FORECASTING SYSTEMS AT REGIONAL AND SUB-REGIONAL SCALES

G. Zodiatis⁽¹⁾, G. Galanis⁽²⁾, A. Nikolaidis⁽¹⁾, H. Radhakrishnan⁽¹⁾, G. Emmanouil⁽³⁾, G. Nikolaidis⁽¹⁾, R. Lardner⁽⁴⁾, S. Sofianos⁽⁵⁾, S. Stylianos⁽¹⁾, M. Nikolaidis⁽¹⁾, V. Vervatis⁽⁵⁾ and G. Kallos⁽⁵⁾

⁽¹⁾ Oceanography Centre, University of Cyprus, Nicosia 1678, Cyprus, oceanosgeos@gmail.com

⁽²⁾ Hellenic Naval Academy, Section of Mathematics, Piraeus 18539, Greece

⁽³⁾ Environmental Research Laboratory, NCSR, Agia-Paraskevi Attikis, Greece

⁽⁴⁾ Simon Fraser University, Burnaby, British Columbia, Canada

⁽⁵⁾ University of Athens, Ocean Physics and Modeling Group, Athens15784, Greece

Abstract

one of the well known ocean forecasting systems in the Mediterranean is the Cyprus Coastal Ocean FOrcasting System (CYCOFOS). Following the establishment of the Copernicus Marine Environmental Monitoring Service (CMEMS), CYCOFOS has been improved to downscale the CMEMS Mediterranean MFC, with new hydrodynamic, wave and atmospheric models, at sub-regional and regional scales. The new CYCOFOS hydrodynamic model uses a novel parallel version of POM, coupled with the SKIRON surface forcing and with the new CYCOFOS WAM model, providing the surface drag coefficient to the hydrodynamic model. The new CYCOFOS wave model incorporates the surface currents from the CMEMS Mediterranean MFC, providing a second independent forcing, in addition to the SKIRON forcing. The Weather Research and Forecasting model (WRF) has been implemented in the same domain as SKIRON, in order to provide the backup forcing for the CYCOFOS forecasting systems. Extended validations for all the new CYCOFOS forecasting systems were carried out using in situ, satellite and the parent models data. Data from the new CYCOFOS forecasting models is used for the EU-CISE 2020 project aiming to establish a Common Information Sharing Environment to improve the SAR operations and for addressing the EMODnet Check points challenge on “oil leakages”.

Keywords: CYCOFOS, validation, hydrodynamical model, WAM, WRF

1. Introduction

The pre-cursor of the Copernicus Marine Environmental Monitoring Service (CMEMS), i.e. the MyOCEAN Mediterranean forecasting system (Pinardi et al 2015), have been used by the Cyprus Coastal Ocean Forecasting and Observing System (CYCOFOS) from January 2009 until the CMEMS service began the provision of initial and lateral forcing (www.marine.copernicus.eu). CYCOFOS is the result of research activities, following the developments of EC projects in operational oceanography and became one of the forecasting components of European Global Ocean Observing systems (www.eurogoos.eu) and of the Mediterranean operational network for global ocean observing systems (www.mongoos.eu). It has been providing operational forecasts since March 2002 (Zodiatis et. al. 2003), such as currents, sea state conditions, satellite observations, as well as end users applications (oil spill and floating objects predictions). CYCOFOS prior to the present work, has been periodically improved (Zodiatis, et. al 2008; Galanis et al., 2012), following the developments in the framework of EC projects, such as MFSPP, MFSTEP, ECOOP, MERSEA, MyOCEAN and MEDESS-4MS, aiming to upgrade the forecasting activities and to assist the marine environmental security in the European sea, including the Mediterranean. The purpose of this work is to present:

- a) the developments and the implementation of the new CYCOFOS forecasting system and to highlight the main improvements;
- b) validate the new modules of CYCOFOS against in situ and satellite observations and other operational models for the period June 2015 to May 2016;
- c) discuss issues emerging from the new capabilities of the CYCOFOS system and added value of the new modules to the downscaling applications.

2. Results and discussion

The new CYCOFOS modeling systems consist of a weather, wave and a hydrodynamical prediction models enhanced with novel features, tools and capabilities, providing forecasts for a variety of atmospheric and sea conditions information at regional and sub-regional scales. More precisely, the CYCOFOS WRF has been adopted as a backup forcing to the SKIRON surface forcing in the Mediterranean and the Black Sea. In the version adopted, the CYCOFOS WRF parameters used as forcing to the CYCOFOS wave and hydrodynamical models, have been evaluated for a period from June 2015 to May 2016 against SKIRON, satellite data and observations from Integrated Surface Database (ISD) stations, with very satisfactory results. On the other hand, the new ECMWF WAM parallel version has been adopted at regional and sub-regional scales, a coarse domain covering the Mediterranean and Black Sea regions at a 0.05° spatial resolution and a nested one in the Levantine basin at a higher horizontal resolution ($1/60^\circ \times 1/60^\circ$) over a 120 hours forecasting horizon.

The new hydrodynamical CYCOFOS model has been improved (Fig. 1a;b;c) by implementing a new parallel version, based on POM for the Eastern Mediterranean domain at a horizontal resolution of 2 Km, nested to the CMEMS Mediterranean MFC data and using the SKIRON surface forcing at first. The new model takes into account the surface drag coefficient provided by the CYCOFOS wave model. The inter-comparisons of the new CYCOFOS hydrodynamical model with the parent CMEMS Mediterranean MFC model (Fig.1a;b) during the period between June 2015 to May 2016, as well as with ARGO *in situ* temperature and salinity profiles (Fig.1c) show very good estimates for their BIAS, RMSE and the mean absolute difference. Comparisons between SKIRON and WRF atmospheric forcing on the new CYCOFOS hydrodynamic model are also in good agreement.

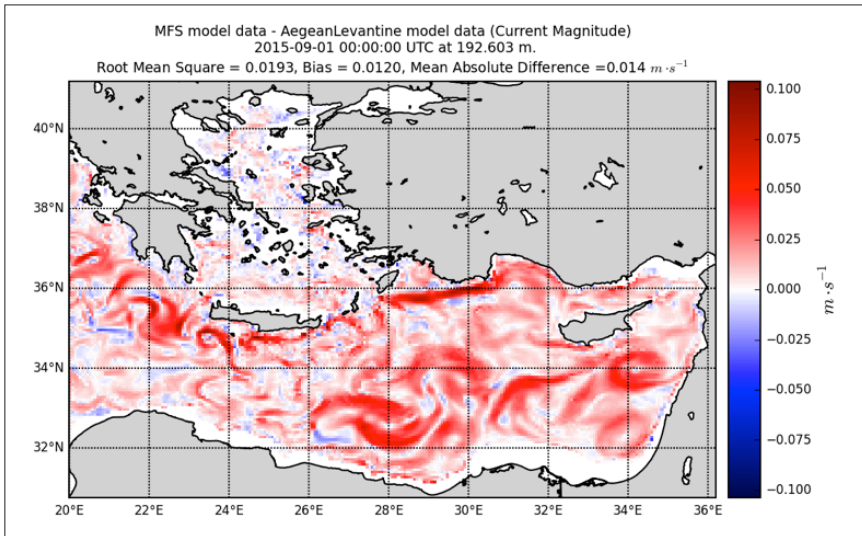

Fig. 1a. Example of the inter-comparisons of the new CYCOFOS hydrodynamical model: differences of currents speed at the depth of 192m vs current speed of CMEMS Mediterranean MFC on the 1/9/2015, using SKIRON surface forcing.

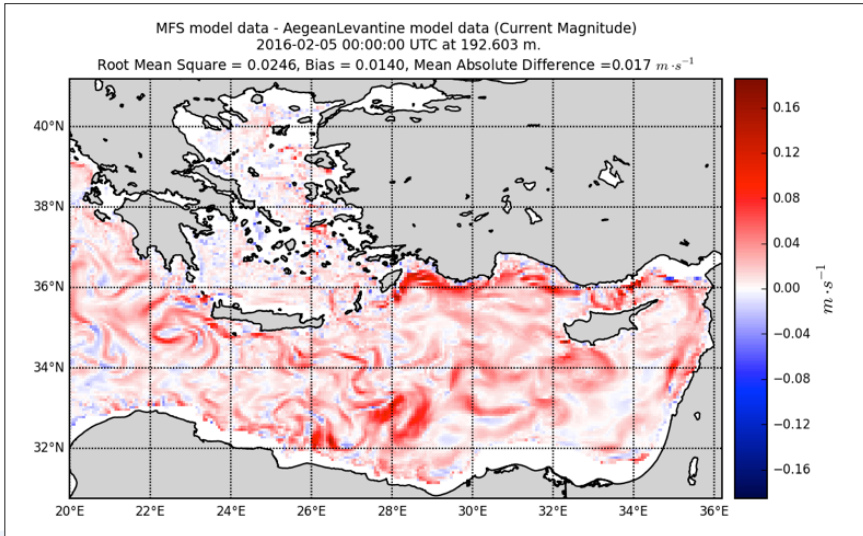

Fig. 1b. Example of the inter-comparisons of the new CYCOFOS hydrodynamical model : differences of currents at the depth of 192m vs current speed of CMEMS Mediterranean MFC on the 5/2/2016, using SKIRON surface forcing.

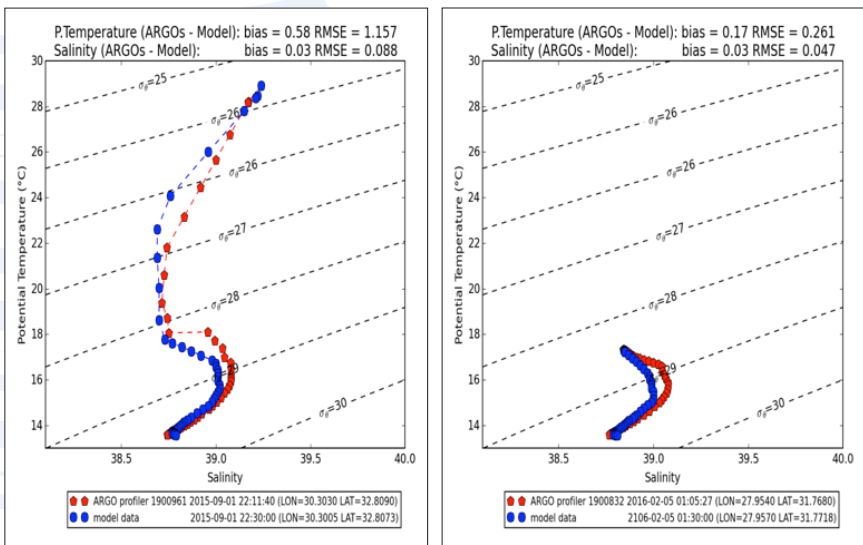

Fig. 1c. Examples of the inter-comparisons of the T/S diagrams of the new CYCOFOS hydrodynamical model vs Argo T/S diagrams for 1/9/2015 and 5/2/2016 (in red colour the ARG0 profile and in blue the CYCOFOS profile). concentrations less than 70% were taken into account as additional grid obstructions.

The evaluation of the SKIRON and CYCOFOS WRF surface forcing, used by the CYCOFOS hydrodynamical and wave models, was carried out against observations from 130 weather stations obtained from the Integrated Surface Database (ISD), for the period June 2015 and May 2016 (Fig.2).

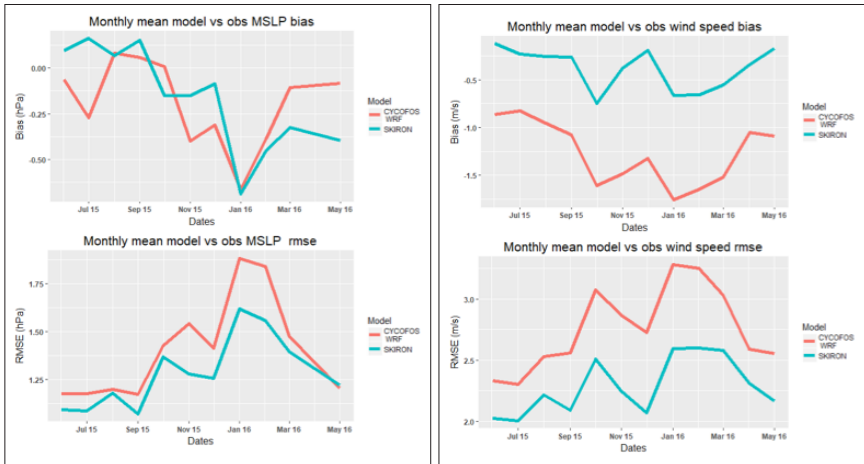

Fig. 2. Statistical evaluation of SKIRON and CYCOFOS WRF vs ISD observational weather stations in the Mediterranean for MSLP and wind speed, between June 2015 and May 2016. (The line in blue is for SKIRON and in red for CYCOFOS WRF).

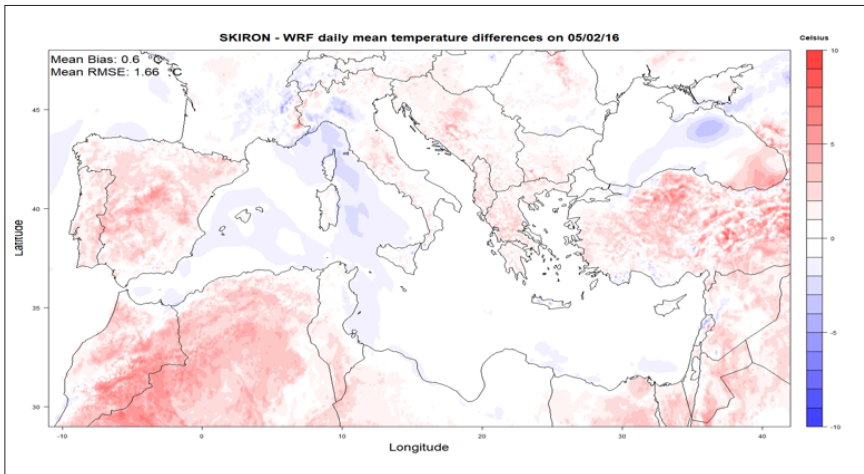

Fig. 3. Example of differences between SKIRON and CYCOFOS WRF on the 5/2/2016.

3. Conclusions

The CYCOFOS new hydrodynamic model has a good agreement with CMEMS Mediterranean MFC for currents, temperature and salinity at surface and sub-surface layers, providing in more details the main flow features and the water masses of the Eastern Mediterranean. Good agreement of the new hydrodynamical model is observed also when compared with ARGO *in situ* profiles, with temperature mean BIAS and RMSE varying from 0.17 to 0.58 and 0.26 to 1.16 respectively, while with salinity mean BIAS and RMSE values 0.03 and .088 respectively. The CYCOFOS WAM performs very well compared to Hadera and Milos stations wave data with BIAS and RMSE reaching up to 0.175 and 0.44 accordingly. CYCOFOS WRF model wind speed also performs very well compared to SKIRON and the observational data from the Integrated Surface Database (ISD). The new atmospheric, wave and hydrodynamical models are coupled exchanging simulation information for wind, the surface drag coefficient and surface fluxes, a fact that makes the new CYCOFOS an integrated, fully operational system able to support research, technical advances and operational downstream needs at sub-regional and regional scales in the Mediterranean.

References

- G. George, D. Hayes, , Zodiatis, P. C. Chu, Y.-H. Kuo and G. Kallos (2012). Wave height characteristics in the Mediterranean Sea by means of numerical modeling, satellite data, statistical and geometrical techniques. *Marine Geophysical Research*, Vol. 33, N. 1, Pages 1-15.
- P. Nadia, M. Zavatarelli, M. Adani, G. Coppini, C. Fratianni, P. Oddo, S. Simoncelli, Marina Tonani, V. Lyubartsev, S. Dobricic, A. Bonaduce (2015). Mediterranean Sea large-scale low-frequency ocean variability and water mass formation rates from 1987 to 2007: A retrospective analysis. *Progress in Oceanography* Volume 132, 318–332.
- Zodiatis, G., R. Lardner, D. Hayes, G. Georgiou, S. Sofianos, N. Skliris, A. Lascaratos (2008), Operational ocean forecasting in the Eastern Mediterranean: implementation and evaluation, *Ocean Science*, 4, 31-47.
- Zodiatis G., Lardner R., Lascaratos A., Georgiou G., Korres G., Syrimis M. (2003). High resolution nested model for the Cyprus, NE Levantine Basin, eastern Mediterranean Sea: implementation and climatological runs, *Annales Geophysicae*, 21, 221-236.

NORTH-WEST EUROPEAN SHELF MONITORING AND FORECASTING CENTRE: SYSTEM EVOLUTION SINCE THE BEGINNING OF CMEMS

M. Tonani⁽¹⁾, N. Mc Connell⁽¹⁾, R. King⁽¹⁾, E. O'Dea⁽¹⁾, M. Martin⁽¹⁾, P. Sykes⁽¹⁾,
A. Ryan⁽¹⁾, A. Saulter⁽¹⁾ and S. Kay^(1,2)

⁽¹⁾ Met Office, UK. marina.tonani@metoffice.gov.uk

⁽²⁾ Plymouth Marine Laboratory, UK

Abstract

The North-West European Shelf Monitoring and Forecasting Centre is delivering physical, biogeochemical, and wave products for the European continental shelf area. The system and its components are continuously evolving in order to increase the number of products offered and their quality. One of the most significant improvements during the last couple of years has impacted the physical component of the system with the introduction of Sea Level Anomaly and temperature, and salinity profile data assimilation. The latest modifications have positively impacted the temperature and salinity fields, with an evident improvement in the model capability to better resolve the water masses at subsurface and mid depth. The temperature RMS error has been reduced by 0.7°C between 500 and 1300m and the salinity RMS error has decreased by 0.04 PSU at the surface, and by up to 0.12 PSU at 1000-1300m. Improved quality of the analysis should reflect in a better predictability capacity of the system. Preliminary assessment of the forecast accuracy has been done for SST to understand how the improved quality of the analysis impacts the forecast accuracy. The analysis from the new system has a lower RMS error than the old system and there is a slower increase in the mean error through the forecast in the new system.

Keywords: forecast, ocean, data assimilation, ocean model, wave

1. Introduction

The North-West European Shelf MFC is delivering physical and biogeochemical real time and reanalysis products for the European continental shelf area. Starting from April 2017 a wave component has been added to deliver forecast products. It is a component of the Copernicus marine environment monitoring service (CMEMS), Le Traon *et al.*, 2017.

2. Description of the system

2.1 Physical and Biogeochemical component

The Forecasting Ocean Assimilation Model 7km Atlantic Margin model (FOAM AMM7) is a coupled hydrodynamic-ecosystem model, nested in a series of one-way nests to the Met Office global ocean model. The hydrodynamics are supplied by the Nucleus for European Modelling of the Ocean (NEMO), Madec 2016, with the NEMOVAR 3D-Var First Guess Appropriate Time (FGAT) system used for the data assimilation (Waters *et al.*, 2015). This is coupled to the European Regional Seas Ecosystem Model (ERSEM), developed at Plymouth Marine Laboratory (PML), which is run on the same model grid as the physical model.

The model is located on the European North-West continental Shelf (NWS), from 40°N, 20°W to 65°N, 13°E, on a regular lat-lon grid with 1/15° latitudinal resolution and 1/9° longitudinal resolution (approximately 7km square). The domain extends beyond the shelf to include some of the adjacent North-East Atlantic, but the focus of this system is on the shelf itself and the deep water is primarily included to ensure there is appropriate cross-shelf exchange. The CMEMS products delivered from this system cover the full model domain (i.e. on and off shelf).

A hybrid s-sigma terrain following coordinate system (following Siddorn and Furner, 2013) with 51 levels is employed in order to retain vertical resolution on the shelf. To reduce horizontal pressure gradient errors over extreme topography the scheme includes a z-S hybrid as described in Madec *et al.*, (1996). The loss of vertical resolution at these points is more than compensated for by reduced errors in the horizontal pressure gradient term. A key feature of the bathymetry dividing the shelf from the deep ocean is the shelf slope, running south to north from Portugal to Norway. Associated with the shelf slope is the important "Joint Effect of Baroclinity And bottom Relief" (JEBAR, Huthnance 1984) which drives a poleward shelf slope current. The shelf slope itself varies in width and steepness. It is particularly steep along the Iberian slope to the west of Portugal and the Cantabrian slope to the north of Spain. The combination of very steep bathymetry and sigma coordinates requires special treatment for modelling horizontal pressure gradients, which is done using a Pressure Jacobian formulation. Bathymetry was supplied by North-West Shelf Operational Oceanographic System (NOOS) partners, who have processed GEBCO 1 arc-minute data together with a variety of other local data sources. The bathymetry was further interpolated in-house to fit with the model grid.

Tidal forcing is included both on the open boundary conditions via a Flather radiation boundary condition (Flather 1976) and through the inclusion of the equilibrium tide. The external elevation and depth mean velocity was determined from 15 tidal constituents taken from a tidal model of the northeast Atlantic (Flather 1981). The model is also one-way nested with the Met Office operational FOAM 1/12° deep ocean model (Storkey *et al.*, 2010) and the CMEMS Baltic MFC system that provides temperature, salinity, sea surface height and depth integrated current information at the open boundaries. Freshwater river fluxes are from a climatology of daily discharge data for 279 rivers from the Global River Discharge Data Base (Vörösmarty *et al.*, 2000) and from data prepared by the Centre for Ecology and Hydrology as used by Young and Holt (2007). Surface forcing is provided from the Met Office's Numerical Weather Prediction model using three-hourly heat and moisture fluxes, and hourly instantaneous fields of wind and surface pressure.

The ecosystem component of the model is supplied by the European Regional Seas Ecosystem Model (ERSEM, Baretta *et al.*, 1995, Blackford *et al.*, 2004). Initially developed collaboratively within the EU, ERSEM has since been further developed at Plymouth Marine Laboratory. It was conceived as a generic model and when coupled to a qualitatively correct physical model it is designed to be capable of correctly simulating the spatial pattern of ecological fluxes throughout the seasonal cycle and across eutrophic to oligotrophic gradients. There are perhaps three reasons that allow ERSEM this flexibility. Firstly, it includes detailed representations of the benthic system, which are vital for the correct treatment of shelf seas. Secondly, it decouples carbon and nutrient dynamics which gives a far better approximation to how nutrient limitation acts on cells than simpler models with fixed carbon:nutrient ratios. Thirdly, it can simulate both the "classical" large cell production / grazing dynamics and the small cell microbial loop, thereby representing the continuum of trophic pathways evident in marine systems.

2.2 Wave component

The WWIII-AMM7 model is a nested regional wave model configuration, defined on an identical grid to other North-West Shelf MFC modelling systems for hydrodynamics and ecosystems. The domain extends beyond the continental shelf in order to place the model's boundary region in the deep waters of the adjacent North-East Atlantic, but the focus region for the model comprises open waters of the shelf seas, i.e. (using UK terminology) the North Sea, Irish Sea, English Channel, Celtic Sea and Bay of Biscay. The present 7km resolution of the model restricts its utility in the coastal zone, where topographic sheltering (e.g. reductions in wave height in the lea of headlands) and strong sub-grid scale variability in shallow water bathymetry will affect the wave field.

Wave models describe ocean surface conditions only, so do not require a vertical coordinate system. Furthermore, the majority of effects on wave propagation and dissipation occur in waters of intermediate or shallow depth as defined relative to the wave frequency (inverse of wave period):

$$d \leq \frac{g}{4\pi f^2}$$

where d is water depth, g acceleration due to gravity and f is wave frequency.

Thus bathymetry is only a controlling mechanism on the wave field for depths below approximately 490 m, based on a minimum frequency in the model of approximately 0.04 Hz (period 25 seconds). The WWII-AMM7 configuration uses the same bathymetry as the equivalent NWS hydrodynamic model, which has been derived from data supplied by the North-West Operational Oceanography System (NOOS) partners, using a synthesis of GEBCO 1-arc minute data together with local data sources. In order to match the grid set-up in the hydrodynamic model, but improve the estimate of wave energy transmission in the vicinity of sub grid scale topographic features such as small islands and coastal headlands, a number of sub grid blocking cells are defined for the wave model following the method described by Chawla and Tolman (2008).

3. Evolution of the forecasting system

The system and its components are continuously evolving in order to increase the number of products offered and their quality. One of the major improvements during the last couple of years has impacted mostly the physical component of the system. The model code, NEMO has been updated to the latest available version (3.6) and the data assimilation scheme has been improved to include SST as well as vertical profiles of temperature and salinity, and satellite Sea Level Anomaly data. Due to a bias in salinity the fresh water river discharge dataset has been changed as well. These three modifications have impacted the quality of the products with an increased quality of the temperature and salinity at the surface as well as at intermediate depths and in the model sea surface height. The accuracy of other physical variables like tides have not been affected by these modifications.

The major differences between the system running since the beginning of CMEMS and the new system, available to the users starting from 19th April 2017, are summarized in the following table:

Table I: Differences between the old and the new system.

	OLD	NEW
Freshwater river fluxes	e-hype historical and forecasted river discharge	Climatological daily discharge data for 279 rivers from the Global Discharge Data Base (Vörösmarty et al., 2000) and from data prepared by the Centre for Ecology and Hydrology as used by Young and Holt (2007)
NEMO code version	3.4	3.6
Data assimilation	2D SST	3D SST, vertical profiles of T and S and SLA

The impact of the latest modifications have been tested in a trial experiment for years 2014-2015 running the two systems (old and new) with the only differences listed in Table I. The initial conditions, lateral boundaries, atmospheric forcing and model parameterization are the same for the two experiments. The major improvements in the new system are in the temperature and salinity variables (Fig. 1) with a mean reduction of the temperature RMS error of 0.7°C between 500 and 1300m depth. The salinity is improved not only due to the data assimilation, of vertical profiles and SLA but also due to the different river discharge dataset used, with a reduction of the RMS error of 0.04 PSU at surface, increasing to 0.12 PSU at 1000-1300m. The new version model code and the SLA data assimilation have improved the SSH statistics, the products no longer have larger errors in winter when there are strong storms in the west part of the model domain. Even though the number of vertical profiles in the shelf area is quite limited and the SLA is assimilated only in the model domain deeper than 700m, there is a positive impact even on the shelf area.

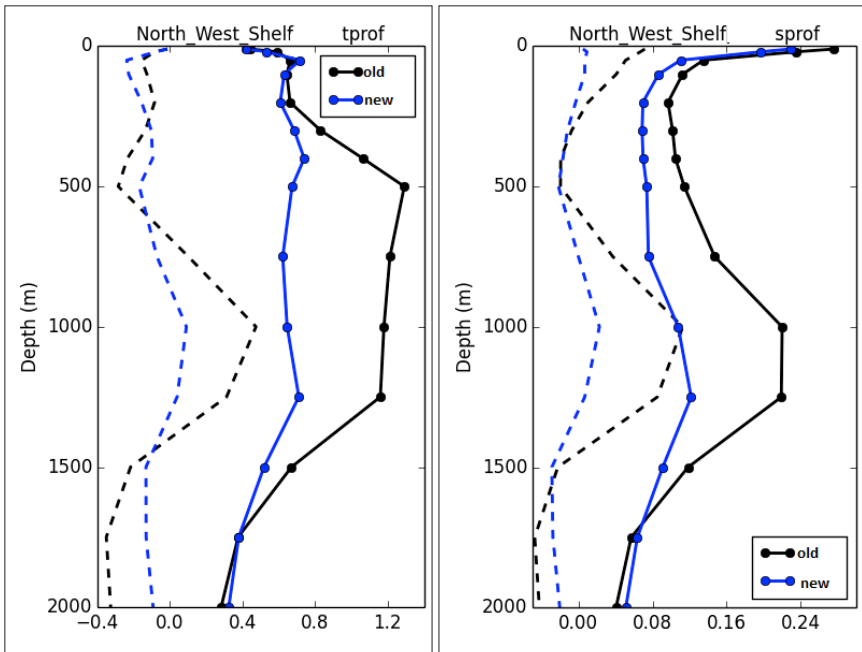

Fig. 1. Observations minus model temperature (left) and salinity (right) for the old (black) and the new (blue) system. The RMS error is shown by the solid lines and the mean error is shown by the dashed lines (positive value indicates a cold model bias). The statistics are computed over the two year run.

4. Conclusion

Improved quality for the analysis should reflect in better predictability capability of the system. Preliminary assessment of the forecast accuracy has been done against SST observations provided by USGODAE, from ships, drifting buoys and fixed buoys. An assessment was performed for four months over the assessment period, one from each season, these being January 2014 (winter) and April 2014 (spring), July 2014 (summer) and October 2014 (autumn). Even though data is sparse for this assessment, particularly so on the shelf, these preliminary results show that the mean error of the old system increases to a much larger extent through the forecast.

References

Articles in journals:

Baretta-Bekker, J. G., Baretta, J. W., and Rasmussen, E. K. (1995): The microbial food web in the European Regional Seas Ecosystem Model, *Neth. J. Sea Res.*, 33, 363–379.

Blackford, J. C., Allen, J. I., and Gilbert, F. J. (2004): Ecosystem dynamics at six contrasting sites: a generic modelling study, *J. Marine Syst.*, 52, 191–215.

Chawla, A. and H. L. Tolman, 2008: Obstruction grids for wave models. *Ocean Modelling*, 22, 12-25.

Flather, R. A., (1976): A tidal model of the northwest European continental shelf. *Memoires de la Societe Royale de Sciences de Liege*, 6, 141-164.

Flather R. A. (1981). "Results from a model of the north east Atlantic relating to the Norwegian Coastal Current". The Norwegian Coastal Current (*Proceedings from the... symposium, Geilo*, 9-12 September 1980). Bergen: Bergen University, 2, 427-458

Le Traon P.Y. and co-authors, The Copernicus Marine Environment Monitoring Service: Main Scientific Achievements and future prospects. *Mercator Ocean Journal*, Special Issue 56, In Press.

Madec, G. and the NEMO team (2016) NEMO ocean engine. *Note du Pôle de modélisation, Institut Pierre-Simon Laplace (IPSL)*, France, No 27 ISSN No 1288-1619.

Siddorn, J., Furner R. (2013): An analytical stretching function that combines the best attributes of geopotential and terrain-following vertical coordinates, *Ocean Modelling*, 66, 1-13

Storkey, D., Blockley, E. W., Furner, R., Guiavarc'h, C., Lea, D., Martin, M. J., Barciela, R. M., Hines, A., Hyder, P., and Siddorn, J. R.: Forecasting the ocean state using NEMO: The new FOAM system, *J. Oper. Oceanogr.*, 3, 3–15, 2010.

Vörösmarty, J., P. Green, J. Salisbury, R. B. Lammers (2000) Global Water Resources: Vulnerability from Climate Change and Population Growth. *Science* 289, 284-288; DOI: 10.1126/science.289.5477.284.

Waters, J., Daniel J. Lea, Matthew J. Martin, Isabelle Mirouze, Anthony Weaver and James While, (2015). Implementing a variational data assimilation system in an operational 1/4 degree global ocean model. *Quarterly Journal of the Royal Meteorological Society* 141: 333 – 349, January 2015 B DOI:10.1002/qj.2388

Young, E. F., Holt, J. T.: Prediction and analysis of long-term variability of temperature and salinity in the Irish Sea.(2007) *JGR Oceans*, Vol. 112, C1, 1-18, doi:10.1029/2005JC003386

EVOLUTION OF THE IBI MFC SERVICES ALONG THE CMEMS PHASE I (2015-2018): SUCCESS STORIES AND FUTURE CHALLENGES

M.G. Sotillo⁽¹⁾, S. Cailleau⁽²⁾, L. Aouf⁽³⁾, C. Toledano⁽⁴⁾, T. Dabrowski⁽⁵⁾, P. Rey⁽⁶⁾, R. Aznar⁽¹⁾, B. Levier⁽²⁾, R. Rainaud⁽³⁾, E. Barrera⁽⁴⁾, P. Bowyer⁽⁵⁾, A. Rodríguez⁽⁶⁾, P. Lorente⁽¹⁾, G. Reffray⁽²⁾, A. Pascual⁽¹⁾, A. Dalphinnet⁽³⁾, J. Villasuso⁽⁶⁾, A. Amo-Baladrón⁽¹⁾, M. Benkiran⁽²⁾, A. Feijo⁽⁶⁾, J.M. García-Valdecasas⁽¹⁾, I. López⁽⁶⁾ and E. Álvarez-Fanjul⁽¹⁾

⁽¹⁾ Puertos del Estado. Madrid, Spain marcos@puertos.es

⁽²⁾ Mercator-Ocean. Toulouse, France

⁽³⁾ Météo-France. Toulouse, France

⁽⁴⁾ AEMET. Madrid, Spain

⁽⁵⁾ Marine Institute. Galway, Ireland

⁽⁶⁾ CESGA. Santiago de Compostela, Spain

Abstract

The CMEMS IBI-MFC (Iberia-Biscay-Ireland Monitoring & Forecasting Centre) delivers daily ocean model estimates and forecasts of different physical and biogeochemical parameters for the Atlantic façade, supporting all kind of marine applications. Along CMEMS Phase-I (2015-2018), the IBI-MFC service is continuously evolving, upgrading its Near-Real-Time forecast capabilities: in 2015, only the physical forecast system was in place. Today, there are 3 NRT services, including a wave and biogeochemical forecasts. The IBI-MFC delivers also multi-year products derived from a physical reanalysis and a non-assimilative biogeochemical hindcast. A new reanalysis run (with updated model, data assimilation and observational data) is performed to improve product quality and extend temporal coverage (back to 1992). The IBI products are generated by model applications able to deal with a large range of physical processes (from tidal to seasonal timescales). Noticeable efforts are in progress to define meaningful skill scores and statistical metrics to quantitatively assess the quality and reliability of these IBI model solutions. To evaluate prognostic capabilities in operations, the NARVAL skill assessment software routinely compares IBI forecast products against in situ and remote-sensing measurements. IBI-MFC operational service maturity is a reality today. On-going actions to ensure service continuity and guidelines of future IBI service evolution planning are outlined.

Keywords:

CMEMS, IBI area, operational service, ocean forecasting, reanalysis, biogeochemistry

1. Introduction: the CMEMS IBI-MFC Service

The Copernicus Marine Environment Monitoring Service (CMEMS) provides regular and systematic reference information on the physical state, variability and dynamics of the ocean and marine ecosystems for the global ocean and the European regional seas. Specifically, the CMEMS IBI-MFC (Iberia-Biscay-Ireland Monitoring & Forecasting Centre) delivers daily ocean model estimates and forecasts of different physical and biogeochemical parameters for the Atlantic façade, supporting all kind of marine applications. In this paper, evolution and achievements of the CMEMS IBI-MFC over the past 3 years (CMEMS Phase-I; 2015-2018) are reviewed. The objective is to illustrate the evolution of the IBI-MFC Near-Real-Time (NRT) forecasting products and the multi-year (MY) ones that comprise physical ocean, biogeochemistry and wave parameters.

2. The IBI-MFC NRT Service evolution

The IBI-MFC service has steadily evolved in the last 3 years. The NRT IBI physical ocean forecast system, existing from MyOcean times, has been progressively upgraded. Furthermore, the IBI MFC extended its NRT forecast capabilities to the biogeochemistry and waves. Most relevant novelties are described below, together with a short descriptions of the 2 new NRT IBI forecast model systems and their products (put in place in the CMEMS V3 release; April 2017).

2.1 The IBI MFC ocean physic Forecast Service Upgrade: Towards IBI regional analysis

One of the major IBI-MFC goals in the CMEMS Phase-1 was to generate regional analysis for the IBI area. To this aim, a significant part of the IBI MFC R&D resources have been dedicated to implement an IBI data assimilation tool to generate weekly regional analysis for IBI waters.

Data assimilation in a high-resolution ocean model system applied to a complex and active tidal region, such as the IBI one, certainly represents a today scientific challenge. The IBI-MFC is adapting and evolving the SAM2 (Système d'Assimilation Mercator version 2; Lellouche *et al.*, 2013) data assimilation method to be applied on shelf seas and in tidal environments. This SAM2 relies on a reduced order Kalman filter, based on SEEK formulation, and had been previously used by MO in different applications (i.e. it is the base of the CMEMS Global MFC analysis system).

Along this 3-years, a step-by-step approach has been followed by the IBI MFC in the transition of the IBI NRT system (originally a free forecast application) towards a system based on a periodic analysis (with a full data assimilation scheme applied), to be implemented at CMEMS V4 release (April 2018).

First step consisted on the substitution of the periodic IBI forecast re-initialization from the parent CMEMS global solution (originally applied in the IBI system) by a new spectral nudging technique methodology (tested and finally applied into operations

in April 2016). The chosen spectral nudging method allows to “nudge” the low frequency IBI solution towards the large scale CMEMS GLOBAL one in those areas where the latter is supposed to be better (mainly off the shelf and in deep waters) due to the assimilation of low frequency signals. Moreover, this new spectral nudged IBI solution overcame two drawbacks of the previous existing IBI versions: a) to avoid the IBI product temporal discontinuity inherent to the periodic re-initialization; b) to minimize dependency from the GLOBAL parent solution on the shelf, where water properties are largely biased by the GLOBAL missing physics (i.e. tides and other high frequency physical processes). After that, the SAM2 DA tool was updated to permit the running of this continuous IBI nudged solution. Currently, the IBI best estimates are operationally produced with this new SAM2 spectral nudging module. The IBI system will be operated in this way until April 2018 (CMEMS V4), when data assimilation through the upgraded SAM2 will be fully activated in the IBI operations.

Other changes in terms of solutions have been introduced in the IBI PHY NRT system along the last 3 years. Among others, in the V3 release, there was an update of the fresh water forcing. The new V3 IBI system includes an additional climatological runoff forcing in coastal points to complement the previous forcing based only on 33 river daily freshwater sources. Furthermore, it is worthy to note how the IBI ocean forecast product is upgraded, being produced now a new 3D hourly dataset for coastal and shelf IBI areas. This high frequency dataset was a recurrent user request and it is of interest for those users interested on generate downstream services by means of model downscaling.

2.2 A New IBI MFC Biogeochemical Forecast Service

The first operational release of an IBI BIO forecast service was done this April 2017 (coincident with this CMEMS V3 release). This new operational system delivers on a weekly basis a +7 Days high resolution (1/36°) biogeochemical forecast. Together with the forecast products, hindcast data are delivered as historic IBI BIO best estimates. The system is based on an application of the biogeochemical model PISCES, running coupled to the IBI ocean forecast solution (see conceptual operational scheme in Fig. 1). The PISCES model (Aumont *et al.*, 2015) can simulate the first levels of the marine food web, from nutrients up to mesozooplankton. The main biogeochemical variables, such as chlorophyll, oxygen, iron, nitrate, ammonium, phosphate, silicate, net primary production and the euphotic zone depth, are distributed as part of this IBI biogeochemical forecast product. Further details on the IBI BIO forecast service can be found in the CMEMS technical reports associated to the IBI MFC NRT biogeochemical forecast product.

2.3 A New IBI MFC Wave Forecast Service

From the CMEMS V3 release, the IBI MFC delivers a new wave forecast service for the whole IBI region. The service system has been jointly developed through collaboration between MeteoFrance, PdE, AEMET and the computer support of CESGA. The new IBI wave system provides a 5-days regional wave forecast product, updated twice a day (cycles at 00z and 12z).

The wave model used as base of this operational system is the MFWAM. This model is based on the IFS-ECWAM (38R2) code with changes regarding to the dissipation by wave breaking and the swell damping source terms as developed by Arduin et al (2010). The MFWAM model was updated in 2014 with the improvements of the FP7 European research project MyWave. The model performs a partitioning technique on wave spectra that allows the separation between wind sea and swell wave systems. A classification of primary and secondary swell system is also performed. The MFWAM model is implemented on the IBI domain with a grid size of 10km and with the spectral resolution of 24 direction and 30 frequencies. IBI WAV runs are driven by 3-hourly analyzed ECMWF winds and uses boundary conditions (wave spectra) from global CMEMS wave system, which has assimilation of wave data.

One of the research lines followed along the latest years by the IBI-MFC has been focused on the wave-ocean coupling. Indeed, the present IBI WAV NRT model set up running in operations is already generating the required wave coupling parameters to be further used as inputs in a coupled IBI NEMO ocean model forecast run.

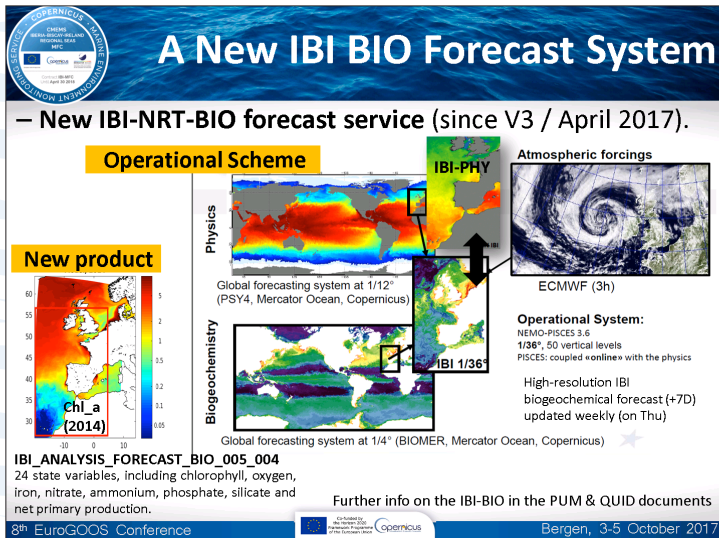

Fig. 1. Conceptual Scheme of the IBI NRT BIO Operational System.

2.4 IBI Product Quality: Qualification & operational Validation of IBI MFC products

The IBI products are generated by model applications able to deal with a large range of physical processes (from tidal to seasonal timescales). Noticeable efforts are in progress to define meaningful skill scores and statistical metrics to quantitatively assess the quality and reliability of these IBI model solutions. To evaluate prognostic capabilities in operations, the NARVAL skill assessment software (with web application) routinely compares IBI forecast products against in situ and remote-sensing measurements (Sotillo et al. 2015, Lorente et al., 2016). Likewise, NARVAL compares the IBI forecast products with other diverse model solutions, by setting up specific inter-comparison exercises on the overlapping areas at diverse timescales, highlighting the coastal quantitative quality assessment of local operational ocean forecasting systems, dynamically embedded in the regional CMEMS IBI solution, as well as in the comparison between these downstream coastal model solutions and the CMEMS core regional and global ones. Together with this routine on-line comparison of local and regional solutions, different off-line scientific validation exercises have been done taken benefit of specific observational campaigns (i.e. Capó et al., 2016 and Sotillo et al., 2016). Scientific Qualification, understood it as the process of qualifying or checking any new product or model development against a series of metrics (using available observational reference data) before their transition into operations, is a key aspect for the IBI-MFC.

The qualification on new products or system may be done with similar metrics to those used later in the operational validation through NARVAL or with specific metrics generated to evaluate specific model sensitivity tests. Fig. 2 illustrate some of the metrics used to validate and qualify the new IBI NRT wave forecast system.

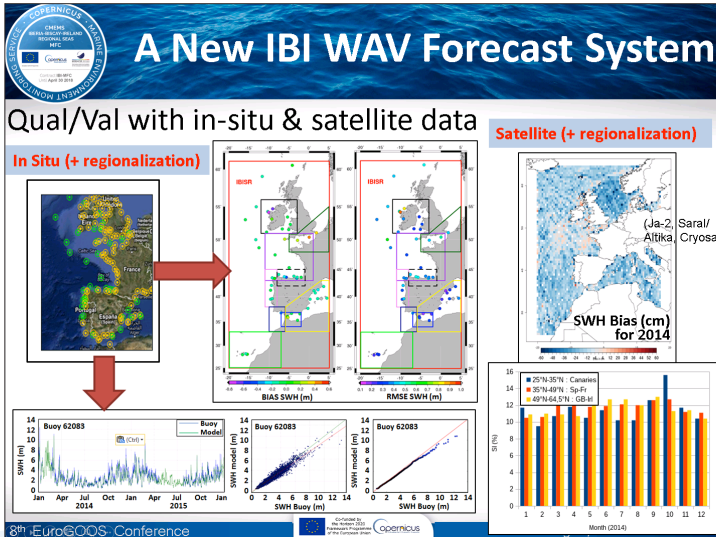

Fig. 2. Example of metrics used to validate and qualify the IBI wave forecast product with satellite and in situ observations from mooring.

3. The IBI-MFC MY product evolution

The IBI-MFC delivers multi-year products from a regional reanalysis for the IBI area, covering initially the 'altimetric' period (from 2002). The MY IBI products provides a complete view of the ocean state, including both physical and biogeochemical parameters. The IBI 1/12° physical reanalysis set-up use the SAM2 data assimilation scheme to constrain the NEMO model solution in a multivariate way with satellite SST, sea level anomalies, and *in situ* observations from the CORA product. A 1/12° non-assimilative PISCES biogeochemical hindcast run, online coupled with the IBI physical ocean reanalysis, generates the IBI MY biogeochemical product.

This IBI reanalysis can reproduce a large range of physical processes from tidal to seasonal scales. Among other IBI reanalysis strengths, point out: realistic inter-annual variability in temperature and sea level together with a realistic reproduction of the Mediterranean Intermediate water, and some other regional features (eg. Bay of Biscay summer jet). On the other hand, some weaknesses mainly related to local biases (i.e. summer upwelling conditions in western Iberian coast) or unrealistic simulation of dynamics (i.e. Gibraltar Strait transports, or Alboran gyres) are identified. The IBI-MFC also has assessed the IBI MY product, in comparison with the NRT free forecast solution (Aznar *et al.*, 2016). Both the IBI forecast and the reanalysis products, compared with several observational data sources, present realistic patterns at regional scales, being highlighted a better performance of the 1/36° forecast in coastal areas whereas

the 1/12° reanalysis does in offshore deep waters. The comparison emphasizes the possible benefits of the data assimilation scheme in areas away from the coastline, but also its limitations in complex coastal regions. Spatial resolution seems to play a key role in such areas, especially around the Iberian Peninsula, where the higher resolution of the forecast model brings in general better results than the coarser resolution reanalysis, suggesting that observational data assimilation represents a crucial step towards improving the performance of regional modelled solutions, as long as spatial resolution is kept at fine-enough meshes to prevent higher uncertainties in coastal and shelf areas.

Nowadays, the IBI-MFC is performing a re-run of the IBI reanalysis to extend its physical and biogeochemical multi-year product back to the year 1992. Product quality improvements are expected since this new re-run is using updated model and DA scheme (NEMO-3.6 + SAM2V1) together with improved ocean boundary conditions (from recently upgraded CMEMS Global reanalysis) and the assimilation of the latest released observational products (i.e. new filtering and subsampling of altimetric data and new *in situ* CORA (V4.1)).

4. The IBI MFC Service: present and future challenges

Maturity of the IBI-MFC operational service is a reality today and some of the on-going actions (i.e. generation of regional IBI analysis in 2018) will certainly increase the meet of user requirements. The IBI-MFC provides a robust and reliable operational service (with new product release and continuous improvement of currently existing products) to a growing user community. This is possible thanks to a continuous R&D activity performed within the IBI-MFC focused on improving the model applications used to generate the IBI solutions, as well as the operational suites used to generate, validate and deliver IBI products. Outside the IBI-MFC, there is a growing use of IBI data products in research activities and downstream applications, resulting in an increase of the scientific literature on IBI. Consequently, the CMEMS IBI user counts today with a more complete picture of what expect from the regional IBI products. With respect to the future evolution of the service, in the short-term, the IBI-MFC will continue with the on-going actions focused on the next milestone: the CMEMS V4 release (April 2018). Meanwhile, it will be designed the plans for the next CMEMS Phase 2 (2018-2021). This planning will follow the guidelines outlined in the long-term CMEMS vision and the CMEMS Service Evolution Strategy (R&D priorities). User communication is a key issue for a user-driven service such as the CMEMS one. More specifically for the IBI MFC is important to enhance the exchanges and links with the user community and potential users in order to identify and define more precisely user requirements and thus being in a better position to plan adequate actions and a service evolution useful to meet them. In that sense, it is especially important for the IBI MFC to reinforce the links with the IBI user community, particularly with and through IBI-ROOS, to ease the IBI product use and the further downstreaming. This strength of links with key users may be done through projects (i.e. the recently approved MyCoast Project).

References

- Ardhuin, F., et al. (2010), Semi-empirical dissipation source functions for wind-wave models: Part I, Definition, calibration and validation, *J. Phys. Oceanogr.*, 40(9), 1917–1941.
- Aumont, O, Ethé, C., Tagliabue, A., Bopp, L., and Gehlen, M. (2015) PISCES-v2: an ocean biogeochemical model for carbon and ecosystem studies, *Geosci. Model Dev.*, 8, 2465–2513, doi:10.5194/gmd-8-2465-2015.
- Aznar R., Sotillo M.G., Cailleau S., Lorente P., Levier B., Amo-Baladrón A., Reffray G., Álvarez-Fanjul E. (2016): Strengths and weaknesses of the Copernicus forecasted and reanalyzed solutions for the Iberia-Biscay-Ireland (IBI) waters. *Journal of Marine Systems*, 159, pp. 1-14.
- Capó E, A. Orfila, J.M. Sayol, M. Juza, M.G. Sotillo, D. Conti, G. Simarro, B. Mourre, L. Gómez-Pujol, J. Tintoré. (2016) Assessment of operational models in the Balearic Sea during a MEDESS-4MS experiment. *Deep Sea Research II* Vol 133, pp 118–131
- Lellouche, Le Galloudec, Drevillon M., Regnier C., Greiner E., Garric G., Ferry N., Desportes C., Testut C.E, Bricaud C, Bourdalle-Badie R, Tranchant B., Benkiran M., Drillet Y., Daudin A., and De Nicola C. (2013). Evaluation of global monitoring and forecasting systems at Mercator Ocean. *Ocean Science*, 9, 57–81, 2013
- Lorente P., S. Piedracoba, M. Sotillo, R. Aznar, A. Amo-Baladrón, A. Pascual, J. Soto-Navarro and E. Álvarez-Fanjul, (2016) Ocean model skill assessment in the NW Mediterranean using multi-sensor data, *Journal of Operational Oceanography* Vol. 9, Issue 2.
- Sotillo M G, S. Cailleau, P. Lorente, B. Levier, R. Aznar, G. Reffray, A. Amo-Baladrón, J. Chanut, M. Benkiran E. Alvarez-Fanjul (2015): The MyOcean IBI Ocean Forecast and Reanalysis Systems: operational products and roadmap to the future Copernicus Service, *Journal of Operational Oceanography*, DOI: 10.1080/1755876X.2015.1014663
- Sotillo MG, A Amo-Baladrón, E Padorno, E Garcia-Ladona, A Orfila, P Rodríguez-Rubio, D Conti, JA Jiménez Madrid, F J de los Santos, E Alvarez Fanjul. (2016) How is the surface Atlantic water inflow through the Gibraltar Strait forecasted? A lagrangian validation of operational oceanographic services in the Alboran Sea and the Western Mediterranean. *Deep Sea Research II*. Vol 133. pp 100-117

ENSEMBLE-BASED DATA ASSIMILATION OF OBSERVATIONS INTO NEMO-NORDIC

L. Axell and Y. Liu

Swedish Meteorological and Hydrological Institute, Norrköping, Sweden, Lars.Axell@smhi.se

Abstract

The operational ocean forecasting system at SMHI, for the North Sea and the Baltic Sea, is based on the model NEMO-Nordic (based on NEMO-3.6) and the ensemble-based data assimilation method 3D EnVar. Here we will show some details of both the ocean forecasting model setup as well as the data assimilation system with some new results from 4D EnVar data assimilation.

Keywords: data assimilation, ensemble, NEMO, Baltic Sea, North Sea

1. Introduction

Following a HELCOM recommendation in the early 1990s, it was decided to start develop a common Baltic Sea model for use as an oil drift forecasting system for the Baltic Sea. This led to the so-called HIROMB (High-Resolution Operational Model for the Baltic) cooperation, which started in 1995 around the Baltic countries. As a result, the co-called HIROMB model (e.g. Funkquist and Kleine, 2007; Axell, 2013) was developed and run at the Swedish Meteorological and Hydrological Institute (SMHI) during 1995-2016, for more than two decades. During this period, the model code was being developed and the grid resolution was successively improved. Nevertheless, in 2016, the HIROMB model was finally replaced at SMHI by the forecasting model NEMO-Nordic, based on NEMO (Nucleus for European Modelling of the Ocean) version 3.6 (e.g. Hordoir *et al.*, 2015; Pemberton *et al.*, 2017). It exists in two different horizontal resolutions, 1.85km and 3.9km, respectively. They are both forced by the NEMO-based storm-surge model NEMO-Storm with 11km horizontal resolution at the boundary in the North Sea. The high-resolution version runs 60 hours ahead four times a day, whereas the lower-resolution version runs ten days ahead twice a day. NEMO-Nordic is scheduled to also be the operational physical model at the Baltic Monitoring and Forecasting Centre (BAL MFC) within Copernicus in the future.

At SMHI, ocean data assimilation was introduced operationally in 2005, starting with the simple method of Successive Corrections (SCM) and later univariate Optimal Interpolation (OI). The implementations of these methods used Background Error Covariances (BECs) that were static but variable in space. These methods improved the ocean forecasts, but in some respects further improvements were needed. One example is that the BECs were set a priori, i.e. they didn't change with the flow situation. Another example is that it was difficult to update model variables that observations were lacking for, e.g. ice or snow thickness.

Other institutes, e.g. in the NEMO community, and in particular in the atmospheric community, use variational data assimilation methods which rely on the minimization of a cost function. The three-dimensional (3D) and four-dimensional (4D) versions of these are called 3D Var and 4D Var, respectively (e.g. Lorenc, 2003). These methods make it possible to assimilate e.g. satellite irradiances directly, and 4D Var takes the time dimension into full account. However, the standard implementations of 3D Var and 4D Var typically use stationary BECs.

2. Ensemble Data Assimilation

To improve the BECs, many different data assimilation methods today make use of an ensemble of model states, to make the BECs flow dependent. Depending on the ensemble, the statistics in the BECs may depend on either climate (e.g. calculated from model states for earlier years) or the actual flow at the time of the analysis (calculated from a forecast ensemble).

The first attempt at ensemble data assimilation at SMHI was Ensemble Optimal Interpolation (EnOI; Oke *et al.*, 2002; Evensen 2003) in an SMHI reanalysis project (Liu *et al.*, 2013). That implementation used a quasi-steady (seasonally dependent) ensemble of model states to calculate the BECs.

One popular ensemble method used often in ocean data assimilation is the Ensemble Kalman Filter (EnKF) introduced by Evensen (1994, 2003). Many similar filters exist e.g. the Singular Evolutive Extended Kalman (SEEK) filter (Pham *et al.*, 1998), the Singular Evolutive Interpolated Kalman (SEIK) filter (Nerger *et al.*, 2005) and many more. All these have flow-dependent BECs, but they are only 3D in the sense that they don't take the time dimension into full account like 4D Var does, which on the other hand usually has stationary BECs. A lot of work has been put into combining these two types of data assimilation methods, which has led to hybrid schemes, for example a mixture between EnKF and 3D Var (Hamill and Snyder, 2000), or Hybrid 4D Var (Gustafsson *et al.*, 2014).

The SEIK filter has been implemented also at SMHI, using the PDAF (Parallel Data Assimilation Framework) implementation by Nerger *et al.*, (2005). It is currently being used to produce a multi-decade, coupled physical-biogeochemical reanalysis within the BAL MFC for Copernicus. The physical model is the low-resolution version of

NEMO-Nordic mentioned above, and the biogeochemical model is SCOBI (Swedish Coastal Biogeochemical model). These results will be reported elsewhere when they are available.

At SMHI we have also implemented a method called Four-Dimensional Ensemble Variational (4D EnVar) data assimilation, based on the work by Liu *et al.*, (2008, 2009). The 3D version of our implementation (3D EnVar) has been used in a physical reanalysis within the BAL MFC and was described in some detail by Axell and Liu (2016). It is also used for our operational forecasts with NEMO-Nordic at SMHI. Here we will describe some recent changes to make the implementation four-dimensional, i.e. 4D EnVar.

3. 4D ENVAR

3.1 Implementation at SMHI

Fig. 1 (a) below shows how time is divided into data assimilation windows of length six hours. The individual observations may come any time during each window. In 3D EnVar, all observations are assumed to be valid in the centre of each window, i.e. at 00 UTC, 06 UTC, etc. The difference between 3D EnVar and 4D EnVar is that in the latter case we take full account of the time dimension. In practice, this means that all observation times are discretized, in our case every hour in a 6-hour data assimilation window. When these are compared with the first guess from the model (the background, which is a short forecast), it is important that the observations are compared with the first guess from the model at the correct time, i.e. not necessarily at the center of the assimilation window as in 3D EnVar.

Further, in 4D EnVar it is also important that the ensemble statistics is valid at the observation time. This implies that we must have one specific ensemble for each discrete time level within the assimilation window. This difference shows up in the cost function J , which in the 3D EnVar case is given by

$$J(w) = \frac{1}{2} w^T w + \frac{1}{2} (HX_b' w - d)^T R^{-1} (HX_b' w - d)$$

where w is the control vector, H is the observation operator, $d = y - Hx_b$ is the innovation vector (where y is the observation vector and x_b is the state vector), R is the observation error covariance matrix, and X_b is a perturbation matrix containing all ensemble statistics (see e.g. Axell and Liu, 2016).

In the 4D EnVar case the cost function is instead given by

$$J(w) = \frac{1}{2} w^T w + \frac{1}{2} \sum_i (H_i M_i X_b' w - d_i)^T R^{-1} (H_i M_i X_b' w - d_i)$$

As we can see by comparing the two equations, in the cost function in 4D EnVar we sum up over all discrete time levels i whereas in 3D EnVar it is assumed that all observations are valid in the center of the assimilation window. In addition, M_i in the 4D EnVar equation represents a run with the full non-linear model until time i , and in 4D EnVar d is replaced by $d_i = y_i - HM_i X_b$. It could be mentioned that there is an intermediate case where we take the time dimension into account regarding the observations and the first guess but not regarding the ensemble statistics (same for each discrete time level). This case is called 3D EnVar FGAT (First Guess at Appropriate Time).

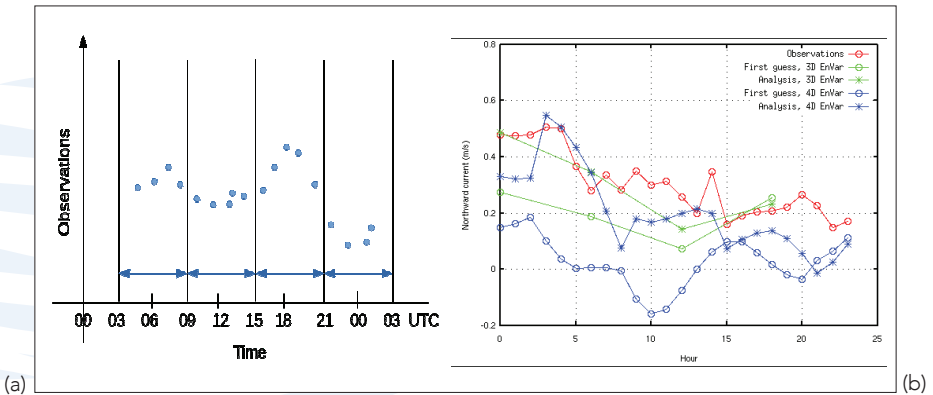

Fig. 1. (a) Time is divided into data assimilation windows, each six hours long. In 3D EnVar, every analysis is done in the center of each window, in this case at 00 UTC, 06 UTC, 12 UTC and 18 UTC. In the 4D EnVar case, there will be one analysis at each discrete time level within each window. (b) Example of assimilation of northward current in the 3D EnVar case (green) and 4D EnVar case (blue), compared with observations (red).

3.2 Results

For many observation types, such as monthly ship observations of slowly varying deep salinity and temperature profiles or SST data, it is not very important to take the time dimension into full account within a short assimilation window. Hence, no great improvements between 3D EnVar and 4D EnVar are expected in these cases. When assimilating variables that change considerably within the assimilation window, there should be room for some improvement, however. Examples of such variables are Sea Surface Currents and Sea Surface Height. To test the 3D EnVar and 4D EnVar schemes, HF radar data from the west coast of Sweden were assimilated into our low-resolution version of NEMO-Nordic during March 2015.

Fig. 1 (b) shows the northward surface current at 58°N 11°E for the sample date 2015-03-10. In the 3D case, analyses are obtained at 00, 06, 12 and 18 UTC, whereas in the 4D case analyses are obtained every hour, i.e. over the whole assimilation window. We see that in the 3D case, the analyses are in general closer to the observations than the corresponding first guesses. In most cases, this is also true for the 4D case. In this example there were 45 ensemble members used in the 3D EnVar case (a semi-static ensemble) whereas in the 4D EnVar case there were only 7 members (taken from lagged 48-hour forecasts) for each discrete time level which is far too few in most circumstances. Summing up the error statistics for the whole month (March 2015), we find that in the 3D EnVar case the Mean Absolute Error (MAE) of the eastward surface current was 0.16 m/s for the first guess and 0.09 m/s for the analysis. In the 4D EnVar case, the MAE of the eastward component was 0.25 m/s for the first guess and 0.21 m/s for the analysis. The corresponding results for the northward component were similar to the eastward component (0.19, 0.10, 0.22 and 0.19 m/s, respectively), i.e. clearly better results in the 3D EnVar case.

To see the impact of the sea-surface current visually, we calculated a monthly mean surface current using HF radar velocities, a free run with NEMO-Nordic, and assimilated runs using the 3D EnVar and 4D EnVar methods; see Fig. 2. According to the observations from the HF radar in panel (a), there is a counter-clockwise gyre in the Skagerrak which is also present in the free run (panel b). The northward current off the Swedish coast seems too narrow in the free run whereas the 3D EnVar scheme (panel c) makes it leave the coast, according to observations, just like the 4D EnVar scheme does (panel d). In addition, the 4D EnVar scheme is more successful in slowing down the strongest currents in the northward current off the Swedish coast; see panel (d).

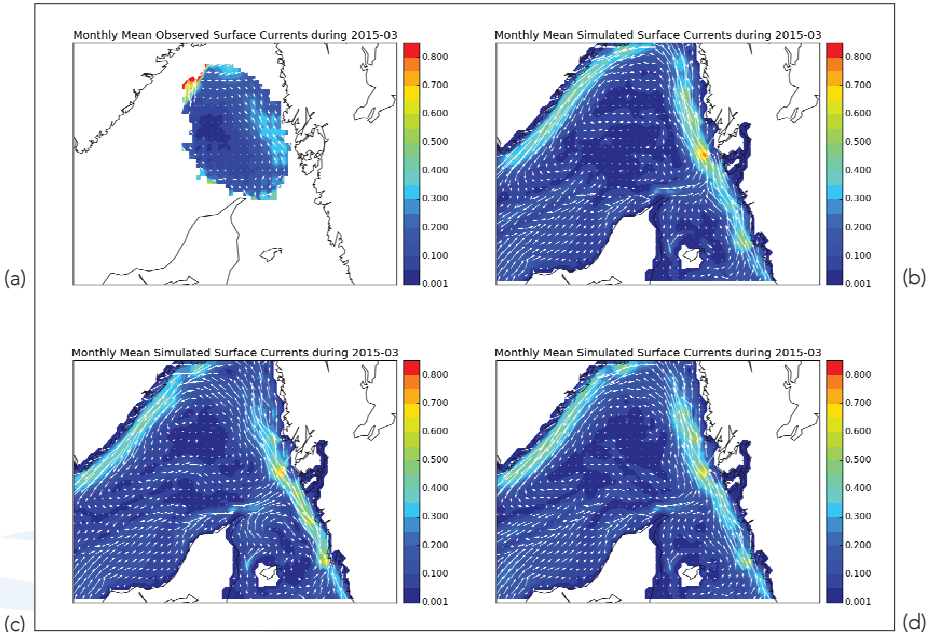

Fig. 2. Monthly mean sea surface current in the Skagerrak in March 2015 according to (a) HF radar currents, (b) a free run with NEMO-Nordic, and assimilated runs using (c) 3D EnVar and (d) 4D EnVar.

4. Discussion

The 3D EnVar data assimilation scheme implemented at SMHI has technically been extended to handle the 4D case, so-called 4D EnVar, by taking the time dimension into account within the data assimilation window. This was done by making a discretization in time with one hour resolution. Each observation has its own (discrete) time level and is compared with the first guess from the model at the correct time level. Further, each time level had to have its own ensemble statistics, also valid at the correct time level. In this work, the 4D EnVar ensemble statistics has been taken from a simple ensemble of lagged forecasts up to 48 hours ahead, giving us only seven members for each discrete time level. In most cases, this is not good enough. According to our experience, we need approximately 50-100 ensemble members to characterize the background error statistics. In the future we hope to be able to set up a more sophisticated ensemble forecasting system to test 4D EnVar with. This may include different initial conditions as well as different meteorological forcing.

Acknowledgements

This work was partly done with financial support from the project JERICO-NEXT, which received funding from the European Commission's Horizon 2020 Research and Innovation programme under grant agreement N°. 654410.

References

- Axell, L. (2013). BSRA-15: A Baltic Sea Reanalysis 1990-2004. *Reports Oceanography*, 45. Swedish Meteorological and Hydrological Institute, Norrköping, Sweden.
- Axell, L. and Liu, Y. (2016). Application of 3-D ensemble variational data assimilation to a Baltic Sea reanalysis 1989-2013, *Tellus A* 2016, 68, 24220, <http://dx.doi.org/10.3402/tellusa.v68.24220>
- Evensen, G. (1994). Sequential data assimilation with a nonlinear quasi-geostrophic model using Monte Carlo methods to forecast error statistics. *Journal of Geophysical Research* 99, 143-162.
- Evensen, G. (2003). The ensemble Kalman filter: theoretical formulation and practical implementation. *Ocean Dynamics* 53, 343-367.
- Funkquist, L. and Kleine, E. (2007). HIROMB: An Introduction to HIROMB, an Operational Baroclinic Model for the Baltic Sea. *Report Oceanography*, 37. Swedish Meteorological and Hydrological Institute, Norrköping, Sweden.
- Gustafsson, N., Bojarova, J. and Vignes, O. (2014). A hybrid variational ensemble data assimilation for the High Resolution Limited Area Model (HIRLAM), *Nonlinear Processes in Geophysics*, 21, 303–323, doi:10.5194/npg-21-303-2014.
- Hamill, T. and Snyder, C. (2000). A hybrid ensemble Kalman filter-3D variational analysis scheme. *Monthly Weather Review* 135, 222-227.
- Hordoir, R., L. Axell, U. Löptien, H. Dietze, and I. Kuznetsov (2015), Influence of sea level rise on the dynamics of salt inflows in the Baltic Sea, *Journal of Geophysical Research Oceans*, 120, doi:10.1002/2014JC010642.
- Liu, Y., Meier, M. and Axell, L. (2013). Reanalyzing temperature and salinity on decadal time scales using the ensemble optimal interpolation data assimilation method and a 3D ocean circulation model of the Baltic Sea. *Journal of Geophysical Research* 118, 5536-5554.
- Liu, C., Xiao, Q. and Wang, B. (2008). An ensemble-based four-dimensional variational data assimilation scheme. Part I: technical formulation and preliminary test. *Monthly Weather Review* 136, 3363-3373.
- Liu, C., Xiao, Q. and Wang, B. (2009). An ensemble-based four-dimensional variational data assimilation scheme. Part II: observing system simulation experiments with Advanced Research WRF (ARW). *Monthly Weather Review* 137, 1687-1702.

Lorenc, A. (2003). The potential of the ensemble Kalman filter for NWP - a comparison with 4D-Var. *Quarterly Journal of the Royal Meteorological Society* 129, 3183-3203.

Nerger, L., Hiller, W. and Schrter, J. (2005). A comparison of error subspace Kalman filters. *Tellus A*. 57, 715-735.

Nerger, L., Hiller, W. and Schröter, J. (2005). PDAF – the parallel data assimilation framework: experiences with Kalman filtering. In: Zwiefelhofer, W. Mozdzynski, G. (Eds.), Proceedings of the eleventh ECMWF Workshop on the Use of High Performance Computing in Meteorology. World Scientific, Reading, UK, pp. 63-83.

Oke, P., Allen, J., Miller, R., Egbert, G. and Kosro, P. (2002). Assimilation of surface velocity data into a primitive equation coastal ocean model. *Journal of Geophysical Research* 107, 3122. DOI: <http://dx.doi.org/10.1029/2000JC000511>

Pemberton, P., Löptien, U., Hordoir, R., Höglund, A., Schimanke, S., Axell, L., and Haapala, J. (2017). Sea-ice evaluation of NEMO-Nordic 1.0: a NEMO-LIM3.6-based ocean-sea-ice model setup for the North Sea and Baltic Sea, *Geoscientific Model Development*, 10, 3105-3123, <https://doi.org/10.5194/gmd-10-3105-2017>.

Pham, D., Verron, J. and Roubaud, M. (1998). A singular evolutive extended Kalman filter for data assimilation. *Journal of Marine Systems* 16, 323-340.



LAST IMPROVEMENTS IN THE DATA ASSIMILATION SCHEME FOR THE MEDITERRANEAN ANALYSIS AND FORECAST SYSTEM OF THE COPERNICUS MARINE SERVICE

J. Pistoia⁽¹⁾, E. Clementi⁽¹⁾, D. Delrosso⁽¹⁾, G. Mattia⁽¹⁾, C. Fratianni⁽¹⁾, M. Drudi⁽¹⁾, A. Grandi⁽¹⁾, D. Paleletti⁽¹⁾, P. Di Pietro⁽¹⁾, A. Storto⁽³⁾ and N. Pinardi^(2,3)

⁽¹⁾ Istituto Nazionale di Geofisica e Vulcanologia (INGV), Bologna, Italy

⁽²⁾ University of Bologna, Italy

⁽³⁾ Centro Euro-Mediterraneo sui Cambiamenti Climatici (CMCC), Italy

Abstract

The Mediterranean Forecasting System (MFS) is a numerical ocean prediction system that produces analyses, reanalyses and short term forecasts for the entire Mediterranean Sea and its Atlantic Ocean adjacent areas. The system is now part of the Copernicus Marine Environment Monitoring Service (CMEMS) providing regular and systematic information about the physical state and dynamics of the Mediterranean Sea through the Med-MFC (Mediterranean Monitoring and Forecasting Center).

MFS has been implemented in the Mediterranean Sea with 1/160 horizontal resolution and 72 vertical levels and is composed by the hydrodynamic model NEMO (Nucleus for European Modelling of the Ocean) 2-way online coupled with the third generation wave model WaveWatchIII (Clementi et al., 2017a) and forced by ECMWF atmospheric fields at 1/8° horizontal resolution. The model solutions are corrected by the data assimilation system (3D variational scheme, Dobricic and Pinardi, 2008) with a daily assimilation cycle of along track satellite Sea Level Anomaly (SLA) and vertical profiles of Temperature and Salinity from ARGO and gliders. In this study we present a new estimate of the background error covariance matrix with vertical Empirical Orthogonal Functions (EOFs) that are defined at each grid point of the model domain in order to better account for the error covariance between temperature and salinity in the shelf and open ocean areas. Moreover the Observational error covariance matrix is z-dependent and varies in each month. This new dataset has been tested and validated for more than 2 years against a background error correlation matrix varying only seasonally and in thirteen sub-regions of the Mediterranean Sea (Dobricic et al. 2005).

Keywords: Data assimilation, EOFs, model error, observational error

1. Introduction

Since year 2000, the Mediterranean Forecasting System, MFS, (Pinardi *et al.*, 2003, Pinardi and Coppini, 2010, Tonani *et al.*, 2014) is providing numerical analysis and forecast of the main physical parameters in the Mediterranean Sea. In the framework of several national and international projects this system has been kept updated and, since April 2015, it provides the physical component of the Med-MFC (Mediterranean Monitoring and Forecasting Center) for the Copernicus Marine Environment Monitoring Service (CMEMS), producing every week the analysis of the previous two weeks and daily providing 10 days forecast at basin scale, that are freely available through the CMEMS Catalogue (<http://marine.copernicus.eu/>, Clementi *et al.*, 2017b). Currently the CMEMS Med-MFC system operationally uses a 3DVAR scheme that assimilates in situ observation of temperature and salinity by ARGO, Gliders and XBT, and along track satellite SLA. In this work we present the upgrade in the background and observational error covariance matrix from the system CMEMS Med MFC V1 (operational up to April 2016), hereafter EAS0, which used EOFs estimated from a climatological model simulation in 13 geographical regions and constant observational errors in vertical, to CMEMS Med MFC V2 (operational since May 2016), hereafter EAS1, in which EOFs are defined at each grid point and the observational error is depth dependent.

The paper is organized as follows: in section 2 the pre-conditioning in the Background Error Covariance Matrix is described, while in section 3 the impact of the different Background Error Covariance Matrixes will be shown and in section 4 the conclusions are presented.

2. Vertical part of the background error covariance matrix

3DVAR finds the minimum of the cost function, J , written as:

$$J = \frac{1}{2} \delta \mathbf{x}^T \mathbf{B}^{-1} \delta \mathbf{x} + \frac{1}{2} [\mathbf{H}(\delta \mathbf{x}) - \mathbf{d}]^T \mathbf{R}^{-1} [\mathbf{H}(\delta \mathbf{x}) - \mathbf{d}] \quad \text{Eq 1}$$

$$\delta \mathbf{x} = \mathbf{x} - \mathbf{x}_b \quad \mathbf{B} = \mathbf{V}\mathbf{V}^T \quad \mathbf{d} = \mathbf{y} - \mathbf{H}(\mathbf{x}_b)$$

In Eq. 1 $\delta \mathbf{x}$ is the analysis increments, the difference between the background state, \mathbf{x}_b , and the truth, \mathbf{x} . \mathbf{H} is the linear interpolation operator that brings the model information on the observation grid, \mathbf{d} is the misfit, i.e. the difference between the background and observation, \mathbf{B} is the Background Error Covariance Matrix and \mathbf{R} is Observational Error Covariance Matrix. Pre-conditioning in \mathbf{B} is modelled through a sequence of linear operators composing \mathbf{V} (Dobricic and Pinardi, 2008):

$$\mathbf{V} = \mathbf{V}_D \mathbf{V}_\eta \mathbf{V}_H \mathbf{V}_V \quad \text{Eq 2}$$

where \mathbf{V}_D applies a divergence-damping filter on the correction field, \mathbf{V}_η calculates the sea surface height error covariance from three-dimensional fields of temperature

and salinity with a barotropic model, \mathbf{V}_h applies horizontal covariances on fields of temperature and salinity, \mathbf{V}_v contains multi-variate vertical Empirical Orthogonal Functions (EOF). The multivariate vertical EOFs consider sea level, temperature and salinity profile anomalies. The temperature and salinity EOFs include the information about the cross-variance between temperature and salinity and thus a water-mass type analysis.

In order to create a more accurate representation of the horizontal variability in the water mass representation in the background error covariance matrix, we decided to compute the vertical EOFs in each grid point of the model domain. EOFs are calculated with a Singular Value Decomposition algorithm applied to a state vector containing temperature, salinity at model levels and sea surface elevation anomalies, for each grid point of the Mediterranean Sea deeper than 75m. The basic model variables are extracted from twelve years of reanalysis (Adani *et al.*, 2011) for the period 2000 to 2011. The temperature and salinity anomalies entering the state vector are calculated as monthly mean deviations and a EOF-box of 10 x 10 grid point profiles is used for each central grid point of a EOF-box since not all model grid point represent independent dynamical states. The EOF-box will naturally involve different depths grid points and only grid points deeper than the target point are considered to build the state vector. This sampling allows us to account for the different bottom shape maintaining the EOF-box smoothing approach, and the resulting state-vector will be very different for shelf or deep-water area.

The daily averaged model field anomalies in each grid point resulted in a minimum dataset of more than 600 multi-variate profiles. The state vector X can then be represented as follows:

$$X = \left(\frac{\delta\eta}{\sigma_\eta}, \frac{\delta T_1}{\sigma_T}, \dots, \frac{\delta T_m}{\sigma_T}, \frac{\delta S_1}{\sigma_S}, \dots, \frac{\delta S_m}{\sigma_S} \right) \quad \text{Eq 3}$$

where σ_η , σ_T and σ_S represent the standard deviation of corresponding fields, and δ indicates the difference between the daily averaged value and temporal mean for each month. Each vector composing Eq.3 is a time series of daily values. As in Dobricic *et al.*, (2006) in order to create EOFs independent from the number and thickness of vertical levels, Dobricic *et al.*, (2016) used to multiply the state vector X by a metric factor matrix g (North *et al.*, 1982) where the diagonal elements are:

$$g = \text{diag} \left(1, \frac{\Delta z_1}{H}, \dots, \frac{\Delta z_m}{H}, \frac{\Delta z_1}{H}, \dots, \frac{\Delta z_m}{H} \right) \quad \text{Eq 4}$$

where the Δz are the model layer thicknesses and H is the model depth of the target point.

The structure of the vertical covariance matrix for the Gulf of Lyon region in winter and March for the EAS0 and EAS1 system respectively, are shown in Fig. 1. Temperature and salinity are correlated with the surface elevation, and the maximum of autocorrelation is in the upper water column. Largest correlation between T and S fields are found at the same levels.

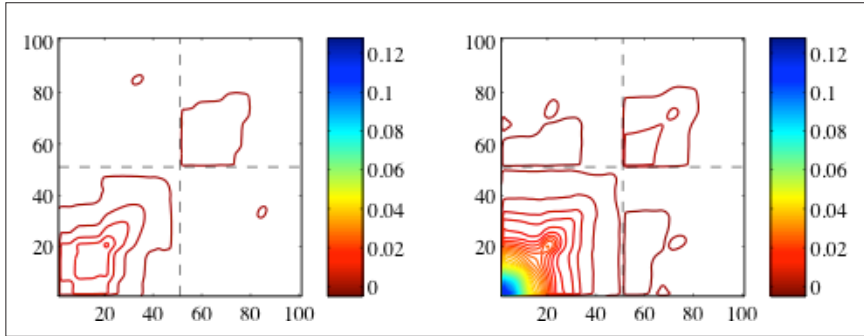

Fig. 1. Vertical Background Error Covariance Matrix for EAS0 (left) and EAS1(right). In the left panel the Vertical Background Error Covariance Matrix is given for a large region in the Gulf of Lyon (northern Mediterranean Sea, Dobricic et al., 2006) during wintertime. In the right panel the matrix corresponds to a central grid point in the Gulf of Lyon valid for the month of March with a depth of 50 levels. The matrix horizontal and vertical dimensions are given by the number of variables in the state vector of Eq. (3), i.e. the sea level anomaly, the first 50 levels of temperature anomalies and the first 50 levels of salinity anomaly profiles. The matrix is composed of 101 x 101 elements and the diagonal corresponds to the sea level variance, temperature and salinity variances at each level that is considered to be the background error. The colorbar is proportional to the background error variance.

2.1 Estimation of the observational error correlation matrix

It is well known that the background and observational error matrices are not completely independent and that the observational error is dominated by representativeness errors. Desrozier’s relation (Desrozier et al., 2005) indicates a semi-empirical algorithm to calculate an optimal balance between the background error, **B**, the observational error **R** and the expected variance of the misfits, $\mathbf{E}(d_b^o d_b^{oT})$

$$\mathbf{E}(d_b^o d_b^{oT}) = \mathbf{R} + \alpha \mathbf{H} \mathbf{B} \mathbf{H}^T \tag{Eq 5}$$

In Eq. 5, The α coefficient in Eq. 5 is an empirical coefficient and different choices can be tried tested on the basis of sensitivity experiments that gave as best guess the value of 0.5. In this way we are implicitly stating that model and observation errors contribute equally to the analysis error. Once the value of α is decided and the expected variance of misfit is calculated from the reanalysis data, we estimate R as a function of the depth and time (the months). We consider R to be uniform in horizontal because of the lack of sufficient data to detect grid point changes in R .

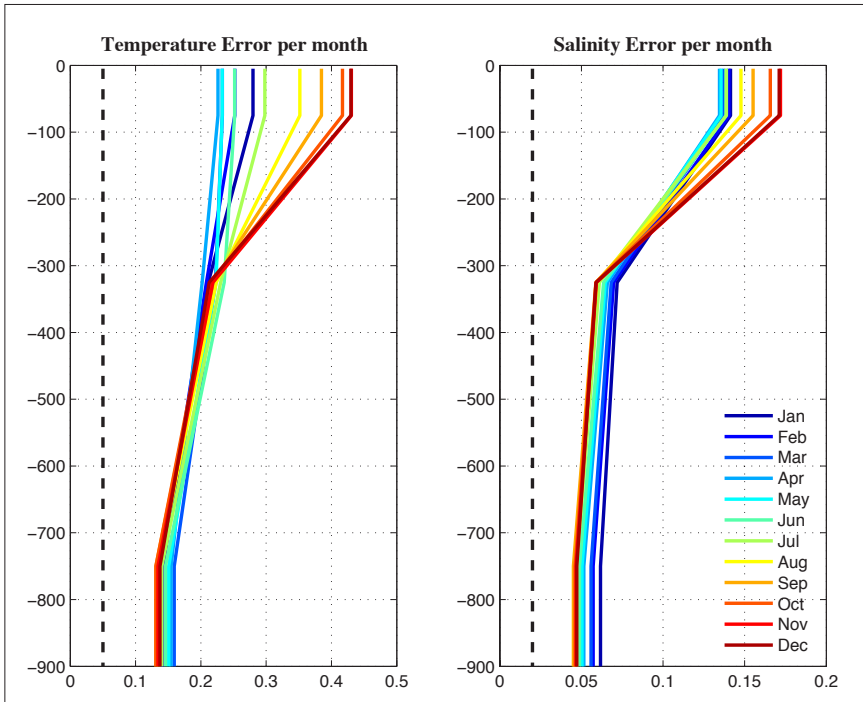

Fig. 2. Observational vertical error profiles for temperature (left panel, [°C]) and salinity (right panel, [PSU]) estimated using Eq. . Black dotted line was the constant value set for EAS0, while the full continuous coloured lines represent profiles stand for the vertical error profiles varying according for each the month. The vertical axis represents the depth expressed in m.

3. Sea level anomaly data assimilation sensitivity experiments

Along track sea level anomalies have been assimilated together with the *in situ* salinity and temperature data in the MFS systems EAS0 and EAS1 for a sensitivity test of one year period (from the 1st May 2014 to 30th April 2015) and results are shown in Fig. 3 in terms of weekly Root Mean Square (RMS) of misfits over the entire Mediterranean Sea. The grid point **B** and the variable **R** structure (in EAS1 experiment) improve the RMS misfit of about 0.3cm, i.e. 10% of the average RMS misfit. On the other hand, the RMS misfit for temperature and salinity (evaluated but not shown here) highlights that EAS1 has an enhanced skill in representing the salinity below the mixed layer depth, while temperature performance in the two systems is similar.

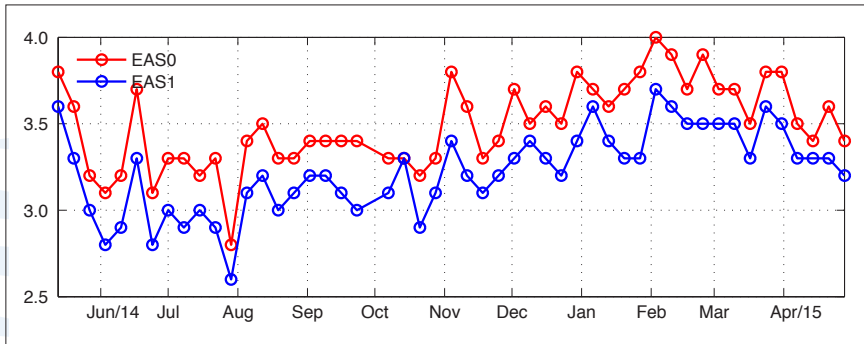

Fig. 3. The weekly RMS of SLA misfits (background-observation) for the assimilation experiment using regional EOF, EAS0 (red line), and the one using the new grid point EOFs (blue line) during the testing period: 1st May 2014 to 30th April 2015. All values are expressed in cm.

4. Conclusions

A new background error covariance matrix has been evaluated to improve the assimilation scheme of the MFS numerical ocean prediction system in the Mediterranean Sea in the framework of the CMEMS Med-MFC. The upgraded system takes into consideration monthly mean values and water mass variability at each grid point of the model domain. In addition, a new observational error matrix has been computed that is vertically and monthly varying, accounting for different representativeness of the *in situ* dataset. Based on one-year sensitivity experiments, the improved assimilation scheme has proved to increase the predicted SLA skill by reducing the RMS misfit of the order of 10% considering an average error of about 3cm.

We are currently investigating the application of the same methodology to a new version of the modelling system with increased resolution of 1/24 degree in horizontal and 141 vertical levels.

Acknowledgements

This work was founded by CMEMS Med-MFC (Copernicus Marine Environment Monitoring Service – Mediterranean Marine Forecasting Centre), Mercator Ocean Service.

References

- Adani, M., Dobricic, S. and Pinardi, N. (2011). Quality Assessment of a 1985–2007 Mediterranean Sea Reanalysis. *Journal of Atmospheric and Oceanic Technology*, 28, 569–589, doi: 10.1175/2010JTECHO798.1
- Clementi, E., Oddo, P., Drudi, M., Pinardi, N., Korres, G. and Grandi A. (2017a). Coupling hydrodynamic and wave models: first step and sensitivity experiments in the Mediterranean Sea. *Ocean Dynamics*. doi: <https://doi.org/10.1007/s10236-017-1087-7>.
- Clementi, E., Pistoia, J., Fratianni, C., Delrosso, D., Grandi, A., Drudi, M., Coppini, G., Lecci, R. and Pinardi, N. (2017b). Mediterranean Sea Analysis and Forecast (CMEMS MED-Currents 2013-2017). [Data set]. *Copernicus Monitoring Environment Marine Service (CMEMS)*. doi: https://doi.org/10.25423/MEDSEA_ANALYSIS_FORECAST_PHYS_006_001.
- Desroziers, G., Berre, L., Chapnik, B. and Poli, P. (2005). Diagnosis of observation, background and analysis-error statistics in observation space. *Quarterly Journal of the Royal Meteorological Society*, 131, 3385–3396, doi: 10.1256/qj.05.108
- Dobricic, S., Pinardi, N., Adani, M., Bonazzi, A., Fratianni, C. and Tonani, M. (2006). Mediterranean Forecasting System: An improved assimilation scheme for sea-level anomaly and its validation. *Q. J. R. Meteorol. Soc.* 131: 3627–3642, doi: 10.1256/qj.05.100.
- Dobricic, S. and Pinardi, N. (2008). An oceanographic three-dimensional variational data assimilation scheme. *Ocean Modelling*, 22, 3-4, 89-105.
- Pinardi, N., Allen, I., Demirov, E., De Mey, P., Korres, G., Lascaratos, A., Le Traon, P-Y., Maillard, C., Manzella, G. and Tziavos C. (2003). The Mediterranean ocean Forecasting System: first phase of implementation (1998-2001). *Annales Geophysicae*, 21, 3-20, doi:10.5194/angeo-21-3-2003.
- Pinardi, N. and Coppini, G. (2010). Operational oceanography in the Mediterranean Sea: the second stage of development. *Ocean Science*, 6, 263-267.
- Raichich, F. (1996). On fresh water balance of the Adriatic Sea. *Journal of Marine Systems*, 9, 305–319.
- Storto, A., Masina, S. and Navarra, A. (2015). Evaluation of the CMCC eddy-permitting global ocean physical reanalysis system (C-GLORS, 1982-2012) and its assimilation components. *Quarterly Journal of the Royal Meteorological Society*, 142, 738–758, doi: 10.1002/qj.2673.

Tonani M., Teruzzi, A., Korres, G., Pinardi, N., Crise, A., Adani, M., Oddo, P., Dobricic, S., Fratianni, C., Drudi, M., Salon, S., Grandi, A., Girardi, G., Lyubartsev, V. and Marino, S. (2014). The Mediterranean Monitoring and Forecasting Centre, a component of the MyOcean system. *Proceedings of the 6th International Conference on EuroGOOS*. Eurogoos Publication n°. 30, ISBN 978-91-97488



THE ROLES OF THE SEA ICE THICKNESS MEASUREMENTS FROM SATELLITES IN THE TOPAZ SYSTEM

J. Xie⁽¹⁾, L. Bertino⁽¹⁾, A. Melsom⁽²⁾, A. Burud⁽²⁾ and M. Müller⁽²⁾

⁽¹⁾ Nansen Environmental and Remote Sensing Center, Thormøhlensgate 47, 5006, Bergen, Norway.
jiping.xie@nersc.no

⁽²⁾ MET Norway, CIENS park, Oslo, Norway

Abstract

Recently, a merged weekly product of Sea Ice Thickness (SIT) from CryoSat2 and SMOS has been distributed, which is available during the winter months since October 2010 and named CS2SMOS. As a potential operational SIT observation in Arctic, the quantitative evaluation of its roles in the TOPAZ system representing the Arctic component of the Copernicus Marine Environment Monitoring Service (CMEMS), is an essential issue due to the well-known SIT errors in most marine forecast systems. At present, TOPAZ jointly assimilates most observed property variables about ocean and sea ice using the ensemble Kalman filter (EnKF), but SIT has not been assimilated. The quality of sea ice thickness results in the present, non-assimilative operational TOPAZ simulations are assessed by comparing with SMOS data. In this study, there are two parallel data assimilation runs (Official and Test) in the same time period. In the Test run, the merged SIT measurements as an additional observation type are assimilated into the system from 19th March 2014 to 31st March 2015. Innovation diagnostics show the SIT misfits can be reduced by CS2SMOS data, and for other model variables (SIC, SST, SLA) no degradation. Validated by independent SIT observations from the Ice Mass Balance (IMB) buoys and from the IceBridge, the RMSDs are reduced about 24.2% (along the buoy 2013F) and 11.5% respectively. The results suggest this kind of SIT observations can be assimilated into TOPAZ well, which leads to the SIT, the sea ice drift and the local sea-water salinity near surface have been dynamically adjusted in the Arctic. Furthermore, based on the degrees of freedom for signal (DFS) obtained from the data assimilation system, the relative impacts of different observations clearly indicate the CS2SMOS has a comparable role to constrain the system of sea ice property.

Keywords: Arctic, sea ice thickness, CS2SMOS, EnKF, bias, impact evaluation

1. Introduction

As a representative of sea ice in Arctic, sea ice concentrations (SIC) has been available since the late 1970s. However, the measurements of Arctic sea ice thickness (SIT), which also is important to describe the Arctic warming extent, are rather sparse. To improve the knowledge of SIT would be greatly beneficial, both for understanding the Arctic climate changes and for ocean and sea ice model developments. Especially in the recent years, SIT products appear at basin scale, although their flaws are clear as unstable precise and discontinuous coverages either on space or time. The TOPAZ forecasting system is a coupled ocean-sea ice data assimilation system (Bertino and Lisæter, 2008; Sakov *et al.*, 2012), on behalf of the operational Arctic forecast system in the Copernicus Marine Services (<http://marine.copernicus.eu/>). However, TOPAZ does not assimilate SIT, although the capability has been demonstrated in Lisæter *et al.*, (2007). To assimilate this kind of SIT measurements from CS2SMOS is expected to improve the accuracy of SIT simulation. Furthermore, the quantitative assessment of the impact of SIT measurements from CS2SMOS will help to design and develop the new SIT observation products in the near future.

2. TOPAZ system descriptions and assimilated data

In the present TOPAZ system, the following observations are assimilated into with a frequency of every week: along-track Sea Level Anomaly; in situ profiles of temperature and salinity; the gridded OSTIA SST and OSI-SAF ice concentration available at last of the analysis day; and the sea ice drifts in the 3 days prior to the analysis time. All measurements are retrieved from <http://marine.copernicus.eu>. In this study, the weekly measurements of sea ice thickness for data assimilation are collected from <http://data.meereisportal.de/maps/cs2smos/version3.0/n> from March 2014 to March 2015. This product is one of the first merged measurements of complementary weekly Arctic sea-ice thicknesses from the Cryosat-2 (C2) altimeter and SMOS radiometer, and named CS2SMOS (Ricker *et al.*, 2017). It is gridded at a resolution of approximate 25 km. The provided observation errors in these products are estimated by the ideal weighting for each observational grid cell, and leads to be underestimation relative to the real observations. Systematic errors as due to the usage of a snow climatology as well as snow-volume scattering may alter the uncertainty estimate. In fact, we also have done some sensible assimilation experiments to verify this issue, and an offset of the Root Mean Square (RMS) observation error is proposed as a function of sea ice thickness as follows:

$$\epsilon_{\text{Offset}} = \min(0.5, 0.1 + 0.15 * d_{\text{SIT}}) \quad (1)$$

where the d_{SIT} means the merged sea ice thickness at grid cell. It is added to the recommended RMS observation errors in this product, and then to be assimilated into the TOPAZ system.

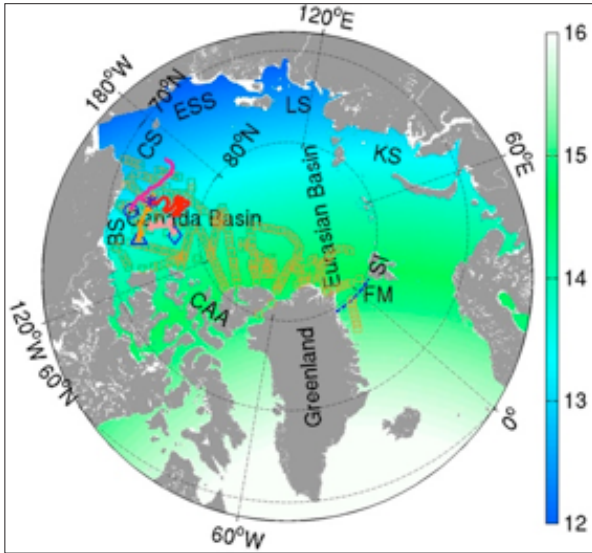

Fig. 1. The horizontal resolutions (km) of TOPAZ4 model grid in the Arctic region ($>60^{\circ}\text{N}$). The black-yellow squares are the locations of SIT from IceBridge in the experimental time period. The four blue markers (star, circle, triangle and diamond) are the first location of IMB buoy trajectories (2013F, 2014B, 2014C, and 2014F respectively).

3. Observation system experiment (OSE) design and results

Based on the 6-hourly atmospheric forcing of ERA-Interim (Dee *et al.*, 2011), two assimilation experiments in the TOPAZ system are driven more than one year since 19th March 2014 until end of March 2015. The two parallel Observation System Experiment (OSE) runs cover two special time periods: at the onset of ice melting in March-April 2014 followed by a free period of CS2MSOS, and a long cold season from October 2014 to March 2015. Using the standard observational network, the control run is named by Official Run, which weekly assimilates the SST, SLA, in situ profiles of temperature and salinity, SIC and sea ice drift data. The CS2SMOS ice thickness data are gridded at 25km resolution, and only available weekly. Considering the different definitions of coastlines and to avoid the related uncertainties, we remove the observations less than 30km away from the coast. To be assimilated into the system, the concerned innovation of SIT in Eq. 1 is calculated as sea ice volume:

$$\Delta \text{SIT} = \mathbf{d}_{\text{SIT}} - \mathbf{H}(\bar{\mathbf{h}}_m \times \bar{\mathbf{f}}_m), \quad (2)$$

where \mathbf{d}_{SIT} is the observed SIT from CS2SMOS as in equation (1), $\bar{\mathbf{f}}_m$ is the ensemble mean of SIC, and $\bar{\mathbf{h}}_m$ is the ensemble mean of ice thickness within the grid cell. Without consideration of the spatial correlation for SIT, the observation error variances are calculated by the sum of the analyzed error from the product provider and the error offset mentioned in Eq. 1. Although the minimal thickness in the model is set 0.1m,

the ensemble mean from 100 model members can take care of very thin value about 1mm so however the SIT observation thinner than 10cm can be assimilated well in the **Test Run**. Every week, if the SITs from CS2SMOS are valid in the previous one week, they are regarded as the present observations to be assimilated into and without considering the time lag.

3.1 Validations of innovation and independent SIT observations

Innovation diagnostics

To investigate whether the data assimilation works well or not, the innovation statics are firstly diagnosed for validation in this study. The mean of innovation is reverted to the traditional bias and the root mean square innovation (RMSI) are calculated for validation at first. Furthermore, based on the formulations proposed in Rodwell et al., (2016) about the total uncertainty in ensemble data assimilation system, it can be expressed as follows:

$$\sigma_{tot} = \sqrt{\text{Bias}^2 + \sigma_{en}^2 + \sigma_o^2} \tag{3}$$

where the bias term is equivalent to the innovation mean, σ_{en} and σ_o represent ensemble spread and RMS observation error at same time respectively. Then the time series of innovation statics for SIT, SIC, SST and SLA can be investigated throughout the whole experimental time period, and represent their misfit evolutions with time on some extent.

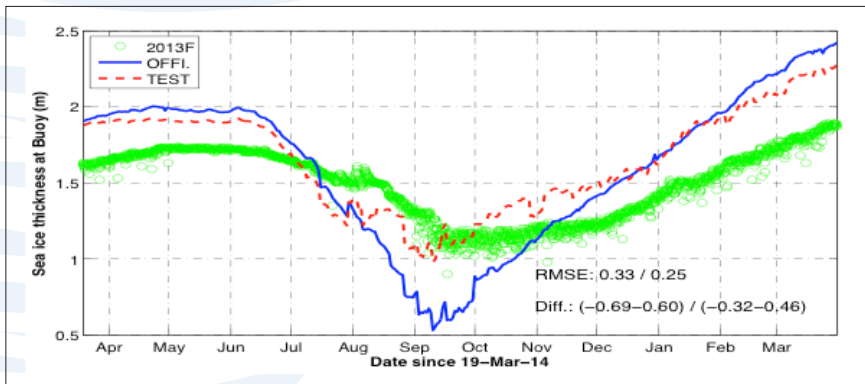

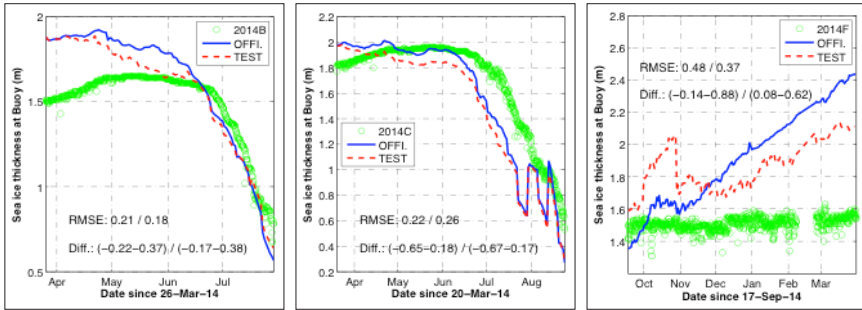

Fig. 2. Time series of SIT along the trajectories of IMB buoys (upper: 2013F; bottom: 2014B, 2014C, and 2014F). The green represents the observed by buoys, the blue from Official run and the red from Test run.

IceBridge Quick Look

The sea-ice thickness from IceBridge Quick Look data set is retrieved by the data from airborne instruments on NASA's Operation IceBridge campaign. They are available via the National Snow and Ice Data Center (NSIDC) during the months of March and April. In the experimental months, all the valid measurements of SIT in Arctic are distributed in central Arctic. The most SITs thicker than 3m are at north of Greenland and Canadian Arctic Archipelago, and the thin sea ice between 1 and 3 m are in Beaufort Sea. In the Official run, the dominant thinning misfits less than -1m are collective at north of Greenland and Canadian Arctic Archipelago. And the thicker misfits more than 0.5m emerge in the Beaufort Sea. This misfit dipper pattern is consistent with the validation result of Xie *et al.*, (2017) when the TOPAZ reanalysis are compared with the SIT from ICESat of 2003-2008. Then after assimilating the SIT from CS2SMOS, the thinning and the thicker misfits are weakened simultaneously. On average, the RMSD of SIT in the Test run is about 1.08m, corresponding to the 11.5% reduction of the RMSD in the Official run. The linear regressions suggest that the SIT in Test run has a well linear correlation with the observation, and the linear bias also can be reduced by the assimilation of CS2SMOS data. Based on the SIT observations from IceBridge in March and April of 2011, the TOPAZ reanalysis also has been evaluated by Xie *et al.*, (2017). It shows the SIT RMSD is about 1.39m with a correlation of 0.5.

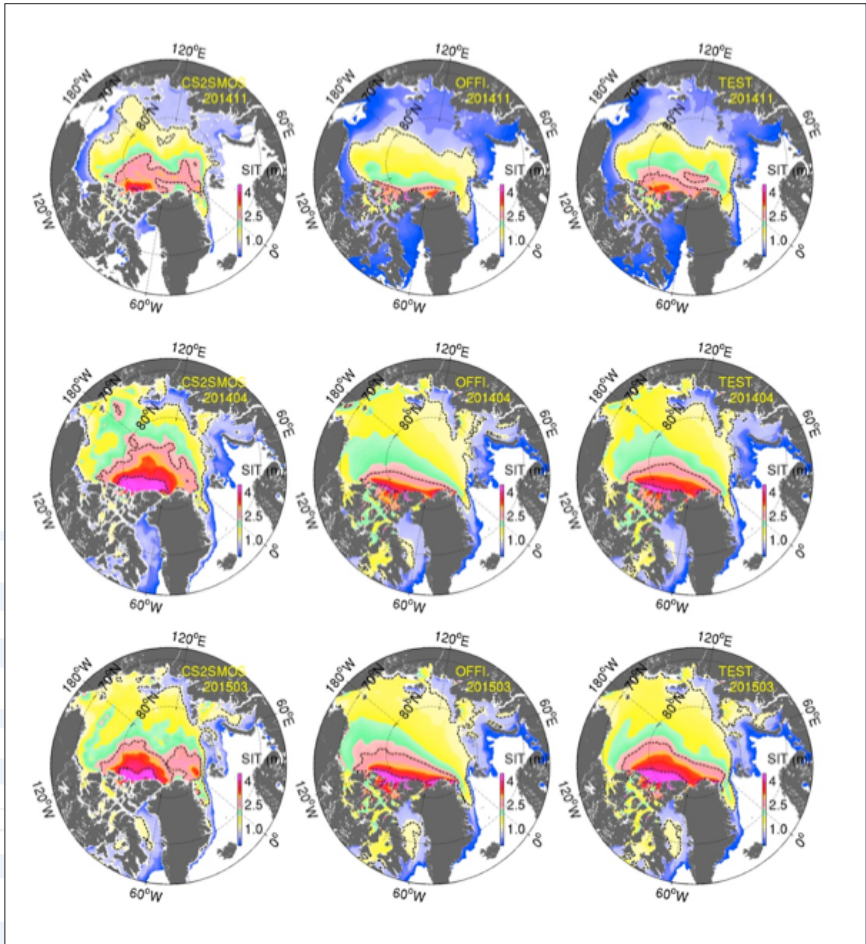

Fig. 3. Monthly SIT from CS2SMOS (left), Official run (middle) and Test run (right) in April 2014, November 2014, and March 2015. The dashed lines are isotherms of 1.0, 2.5 and 4 meter respectively.

IMB Buoys

Shown as Fig. 1, four IMB buoys are involved in this study for validation, and all located in Canadian Basin. Only one trajectory of Buoy 2013F covers the whole time period of the two OSE runs. Shown as the green circles in the upper panel of Fig. 2, the SIT at the Buoy of 2013F has a dominant seasonal variability: the SIT thicker than 1.5m in spring 2014 gradually changes to near 1.0m in summer 2014, and then becomes more and more thick over 1.5 in the early spring of 2015. Along this buoy, the SIT from Official run explores the above seasonal variation, but the thinning deviation in September 2014 is too noticeable as the blue line. After assimilating the SIT from CS2SMOS, the thick deviation of SIT has a little improvement and the latter thinning looks to be membered in the following months. Even in September 2014, the simulated SIT (shown as the red-dashed line) in Test run is marched well with this buoy. In the last part of after November 2014, the SIT increasing trend has been turned by this data assimilation, which leads to the thick deviation in the early spring of 2015 becomes more close to the observations. On average, the root mean square error (RMSE) of SIT, calculated by Eq. 8, in the Official (Test) run is about 0.33m (0.25m) at the buoy of 2013F. Also the misfit range in Official run is from -0.69m to 0.6m, and that in Test run from -0.32m to 0.46m.

3.2 Impact evaluations

At the beginning of two OSE runs in this study, the mean SITs in April are contrasted in the upper panels of Fig. 3. Compared with the observed SIT from CS2SMOS, the pack sea ice at north of Greenland Island and Canadian Arctic Archipelago is underestimated clearly in Official run. Through the assimilation of SIT in the early half month, the thick sea ice around there becomes more thicker and more wider in Test run. Meanwhile, the thin sea ice (<1 m) appearing at the northern Barents Sea, in the Kara sea and the Lapetov Sea has been adjusted due to this assimilation (shown as the isoline of 1 m). It means the overestimation of thin sea ice at the mentioned marginal zones has been limited by assimilation. In November 2014, the SIT data from CS2SMOS are assimilated again at begin. Compared with the Official run, the thick sea ice at north of Canadian Arctic Archipelago becomes more thick and the distribution also has been adjusted as shown the isoline of 2.5m in the middle row panels of Fig. 3. The thickest SIT emerges at north of Greenland Island in Test run. After assimilation of SIT observations, this center has been moved to north of Canadian Arctic Archipelago, which is consistent with the explored by CS2SMOS. Furthermore, the overestimates of thin sea ice in the Kara Sea, the Lapetov Sea, and the East Siberian Sea have been reduced by the assimilation of SIT measurements. The coverage of thin sea ices, shown as the blue shading areas, becomes more narrow in Test run.

4. Conclusions and discussions

The merged SIT measurements as an additional observation type are assimilated into TOPAZ4 from 19th March 2014 to 31st March 2015. Innovation diagnostics show the SIT misfits are reduced and no degradation to other model variables. Validation of independent SIT observations from the IMB buoys and the IceBridge shows the SIT misfits also reduced, and the SIT distribution pattern has been adjusted by CS2SMOS. Furthermore, based on the DFS information, the observation impacts clearly indicate the CS2SMOS has a comparable role to constrain the system drift of sea ice property.

However, The weekly product of CS2SMOS covers the winter months from middle of October to middle of April since 2010. Due to its time lag (depending on the availability of two kinds of SIT measurements), it could be difficult for real forecasting run. The DFS information depends on the concerned error estimates and the observational locations. The SIC impact in the central Arctic probably underestimates due to the model can not resolve melt pools. The reasonable estimate for the SIT observation error of CS2SMOS still has a trick to effect the assimilation performance.

Acknowledgements

The authors acknowledge the CMEMS Phase 1 contract for the Arctic MFC. Grants of computing time (nn2993k and nn9481k) and storage (ns2993k) from the Norwegian Sigma2 infrastructures are gratefully acknowledged.

References

- Bertino, L., and K. A., Lisæter (2008), The TOPAZ monitoring and prediction system for the Atlantic and Arctic Oceans, *Journal of Operational Oceanography*, 1(2), 15–19, doi: 10.1080/1755876X.2008.11020098, 2008
- Lisæter, K. A., G. Evensen, and S. Laxon (2007), Assimilating synthetic CryoSat sea ice thickness in a coupled ice-ocean model, *J. Geophys. Res.*, 112, C07023, doi:10.1029/2006JC003786.
- Ricker, R.; Hendricks, S.; Kaleschke, L.; Tian-Kunze, X.; King, J. and Haas, C. (2017), A weekly Arctic sea-ice thickness data record from merged CryoSat-2 and SMOS satellite data, *The Cryosphere*, 11, 1607-1623, doi:10.5194/tc-11-1607-2017
- Rodwell, M. J., Lang, S. T. K., Ingleby, N. B., Bormann, N., Hólm, E., Rabier, F., Richardson, D. S. and Yamaguchi, M. (2016), Reliability in ensemble data assimilation. *Quart. J. Roy. Meteor. Soc.*, 142, 443–454, Doi: 10.1002/qj.2663.
- Sakov, P., Counillon, F., Bertino, L., Lisæter, K. A., Oke, P. R., and Korablev, A., 2012. TOPAZ4: an ocean-sea ice data assimilation system for the North Atlantic and Arctic. *Ocean Science*, 8(4), 633–656. <http://doi.org/10.5194/os-8-633-2012>

Xie, J., Bertino, L., Counillon, F., Lisæter, K. A., & Sakov, P., 2017. Quality assessment of the TOPAZ4 reanalysis in the Arctic over the period 1991–2013. *Ocean Science*, 13(1), 123–144. <http://doi.org/10.5194/os-13-123-2017>.

Xie, J., Counillon, F., Bertino, L., Tian-Kunze, X., & Kaleschke, L., 2016. Benefits of assimilating thin sea-ice thickness from SMOS into the TOPAZ system. *The Cryosphere*, 10 (November), 2745–2761. <http://doi.org/10.5194/tc-10-2745-2016>.

TOWARDS A NEW SEA LEVEL FORECAST SYSTEM IN PUERTOS DEL ESTADO

I. Pérez González, B. Pérez Gómez, M.G. Sotillo and E. Álvarez-Fanjul

Puertos del Estado, Área de Medio Físico. Avenida del Partenón, 10. Madrid (Spain). ipg@puertos.es

Abstract

In the last years, there has been a major development of forecast systems including a sea level solution in the European domain which, together with the establishment of the CMEMS programme, has fostered model development and data exchange policies. In this context, the Spanish Ports and Harbours Authority (PdE) has analysed, under the national SOPRANO project, the sea level solution of the CMEMS models covering the Iberia-Biscay-Ireland and Mediterranean regions, at locations with tide gauges. PdE's operational sea level forecasting system, Nivmar, has also been included in the study. The simple yet effective low frequency nudging scheme applied in Nivmar has been extended to all models: the analysis has been therefore applied to the solutions before and after nudging. Additionally, the performance of the Bayesian Model Average (BMA) method has been tested on 2 different model overlap subdomains. Results show how baroclinic models are now outperforming Nivmar especially in the original model signal. This means that baroclinic models have improved its capability to solve the longer period baroclinic signal, which is introduced in barotropic Nivmar via nudging. The new BMA joint solution provides a better solution than the individual models in subdomains where individual model performance metrics are more dispersed.

Keywords: Sea level, multi-model, forecasting, CMEMS

1. Introduction

In the last years, there has been a major development of forecast systems including a sea level solution in European and Mediterranean basins, with more sources in the Mediterranean, new baroclinic models and availability of high resolution local models. The sea level forecast system under development in PdE is a multi-model forecast based on an earlier pre-operational implementation of ENSURF (ENsemble SURge Forecast, Pérez-Gómez *et al.*, 2012). ENSURF improves sea level forecasts at locations with tide gauges, by means of the Bayesian Model Average technique (BMA): individual forecasts are combined with weights according to its performance assessment results in a recent training period (further details can be found in the reference given). ENSURF covers the Iberia-Biscay-Ireland and Mediterranean subdomains.

The key elements to the system are therefore: i) access to data sources (observations and models); ii) data tailoring to system needs and iii) probabilistic forecast through BMA. Elements i) and ii) deserve special attention, as data sources and the way the system accesses to them have changed since the last implementation; also, a further insight into the sea level data flow definition to enhance system output performance has now been possible. Sea level data flow and data sources are described in section 2. Results of the inter-comparison between individual sea level forecasts are included in section 1.2, while performance of the BMA is presented in section 4. Focus has been placed on regional forecasts covering the Bay of Biscay (Biscay) and Western Mediterranean (*Mediterranean*) subdomains (Fig. 1) during the analysis period October-2016 to August-2017.

2. Sea Level Data Flow: observed to final bma forecast

Sea level records are basically the combination of a tidal signal, meteorological effects and density effects. Throughout this text, we will refer to the total signal as *sea level*, to the astronomical tidal component as *tide* and to the difference between both signals as *residual*.

In the ENSURF scheme, final sea level forecasts at tide gauge locations are built by adding the BMA residual forecast to the tide prediction derived from the observed tidal curve. To obtain the BMA solution, data from the different sources must be first de-tided to obtain the residual (meteorological) signal when the model includes tide: the approach followed in ENSURF is detailed in section 1.1. Afterwards, the low frequency signal of the forecasted residuals is nudged towards the observed residual (low frequency nudging) using the Nivmar scheme (Álvarez Fanjul *et al.*, 2001). Nivmar effectively couples the HAMSOM modelled signal to the observed signal at the low (monthly to seasonal) frequencies. Finally, residual forecasts combined in the BMA are added to the tide prediction to output the sea level forecast.

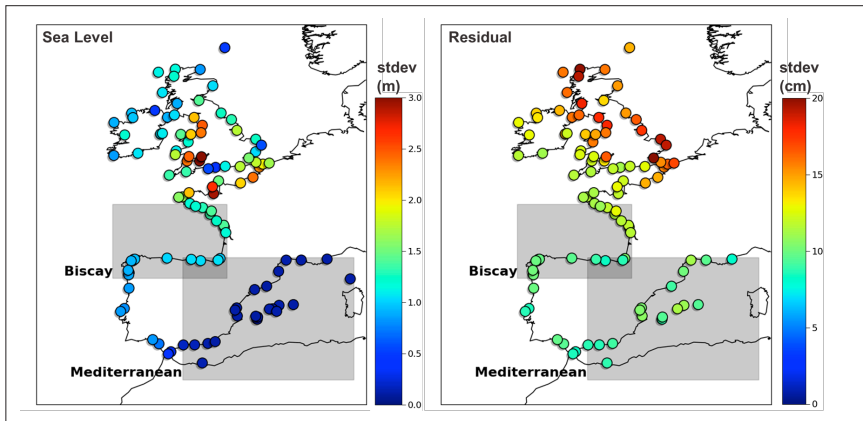

Fig. 1. Observed total sea level (left) and residual (right) at tide gauge stations in the ENSURF domain (Canary Islands excluded). Note the scale and units are different for both parameters. Study subdomains on which this study is focused are highlighted on both maps.

2.1 Estimation of the residual (meteorological) signal

In a multi-model system, output from the individual forecasts is to be combined at some point. As already pointed out in Pérez-Gómez *et al.*, 2012, first main differences among models can arise from i) the actual parameter forecasted (sea level or residual); ii) vertical reference and iii) the astronomical harmonics constituents used to force the model (when it includes tide). These differences must be dealt with in order to harmonize the individual solutions. Additionally, ENSURF assumes a normal distribution in the competing predictors, which forces harmonization necessarily towards the estimation of the residual component. The latter requirement may be envisaged as a system limitation, but it is in fact, the best way to optimize the final prediction of sea level: the meteorological component is extracted from the individual predictions, while the tidal component is best obtained through the tidal harmonics estimated from every sites' observed historical records.

Sea level de-tiding after harmonic analysis is, initially, a straightforward process. However, even assuming the analysed record is long enough to extract all the significant harmonics contributing to the tidal signal at a site (including as much shallow water components as required), the resulting residual can be still contaminated by tidal energy. This energy results mainly from the presumption that tides are purely deterministic (Bernier and Thompson, 2015): we estimate the deterministic tide from the harmonic analysis of the sea level series, whilst a non-deterministic component or tidal remnant remains unsolved. Seasonal variations originating in stratification changes (Müller *et al.*, 2014) among other low frequency signals, or higher frequency

changes such as non-linear tide-surge interaction (Horsburgh and Wilson, 2007) gives the tidal prediction a degree of uncertainty that shows in tidal energy in the residual. Although usually forced at the domain’s boundary by a limited set of constant tidal harmonics, sea level forecasts of models including tide are also affected by non-stationarity, derived from imposed seasonal cycles, wind stress and local heat fluxes among others, which, in addition, couple with further harmonics developed as the imposed tide propagates through the model domain and interacts with the model bathymetry.

Therefore, after frequency analysis of the initial *residuals* obtained by subtraction of the high frequency (>30h⁻¹) tidal signal, the application of a low pass (>15h⁻¹) fft filter has been considered the best approach to deal with the tidal remnant. In this way, we ensure that the same frequencies are represented in all the residual sources that are going to be combined in the final BMA solution.

2.2 Data sources

The establishment of the CMEMS programme has fostered model development and data exchange policies, allowing real-time operational access to observations and sea level forecasts, thereby saving the burden of establishing specific data exchange agreements with providers. ENSURF has taken advantage of this new scenario, and accesses observed and forecasted sea level through the CMEMS InSTACs (*In Situ Thematic Assembly Centre*) and MFCs (*Monitoring Forecasting Centre*), respectively. Additionally, the dynamic component of Nivmar, HAMSOM, is also integrated via direct access to PdE database.

The three CMEMS regional scale models considered in this study are IBI (*Atlantic-Iberian Biscay Irish-Ocean Physics Analysis and Forecast*), MED (*Mediterranean Sea Physical Analysis and Forecasting*) and NWS (*North-West Shelf Physical Forecast*). For the sake of completeness, the CMEMS Global (*GLO, Global Sea Physical Analysis and Forecasting*) is also initially included. Basic information on the models related to sea level output is given in Table I. Detailed information on the CMEMS systems can be found at <http://marine.copernicus.eu>.

Table I. Basic characteristics of sea level forecasts included in the present study. “Tide” indicates the inclusion of tidal forcing; “Pressure” indicates inclusion of pressure effects and “SLA” assimilation of satellite sea level products.

	INTEGRATION	RESOLUTION	OUTPUT	TIDE	PRESSURE	WIND	SLA
HAMSOM	Barotropic	~4 km	Residual	X	✓	✓	X
GLO	Baroclinic	~8 km	Residual	X	X	✓	✓
IBI	Baroclinic	~2 km	Sea level	✓	✓	✓	X
MED	Baroclinic	~6-7 km	Residual	X	✓	✓	✓
NWS	Baroclinic	~6 km	Sea level	✓	✓	✓	✓

3. Model Inter-Comparison

Before integration into the BMA, an initial analysis of the individual forecasts performance is carried out. Analysis is based on the individual residual solution, before low frequency nudging in ENSURF. Owing to the differential characteristics of the subdomains considered (compare observed standard deviation of *sea level* and *residual* in Fig. 1) and the models available in each, the analysis is carried out separately.

Taylor diagrams in Fig. 2 (top) summarize the global performance of the *residual* term of the forecasts. Poor results of the GLO forecast are as expected in a system not specifically designed for sea level, as it does not include tide nor pressure effects. Being the inverse barometric effect most important in the Biscay area, its lack shows in the performance metrics compared to those in the Mediterranean. IBI clusters indicate clear over-performance of the system with respect to the rest in both regions. There is an evident drop in all the indicators of the HAMSOM forecast in the *Mediterranean*, the only barotropic model analysed, which is probably related to the highest intensity of the seasonal cycle in that subdomain, only introduced in Nivmar after nudging to observations.

4. The BMA Forecast

Two BMA solutions have been analyzed: *Biscay's* BMA includes the HAMSOM, NWS and IBI forecasts and *Mediterranean's* BMA, integrates the HAMSOM, MED and IBI forecasts. Taylor diagrams in Fig. 2 (bottom) summarize the global behavior of the BMAs, compared to the nudged forecasted *residual* of its members. It is firstly worth noting how the low frequency nudging of the individual forecasts already improves their performance, compared to the direct forecast output in Fig. 2-top (note different scales in the correlation axis) by adjusting the low frequency signal. In the Biscay region, the BMA is not able to clearly outperform the best member in the area (IBI), while in the *Mediterranean*, it clearly improves the global solution of the individual members. Fig. 4, shows how the BMA works to enhance the global solution at Valencia tide gauge during January-February 2017: while MED seems to approach the intensity of the highest positive anomaly in the period (around January 20th) the best, its performance is worse during the other minor anomalies observed at the beginning and end of the period. These misfits are compensated by the other members in the BMA: IBI and NIVMAR.

The uneven behavior of both BMA's can be explained by the separation of the model clusters in the Taylor diagrams of Fig. 2. The IBI model is clearly the best forecast in the *Biscay* region before and after nudging. IBI forecasts are pulled towards the other forecasts with more modest performances during BMA, resulting in a solution that, in the best cases, can only compete equally with IBI. On the contrary, in the *Mediterranean*, forecast metrics of the different members are all clustered more or less around the same point, picturing the situation explained in the time series in Fig. 3:

model performances alternate between events, and we here obtain a clear advantage from the synergies derived from the overlapping of different solutions.

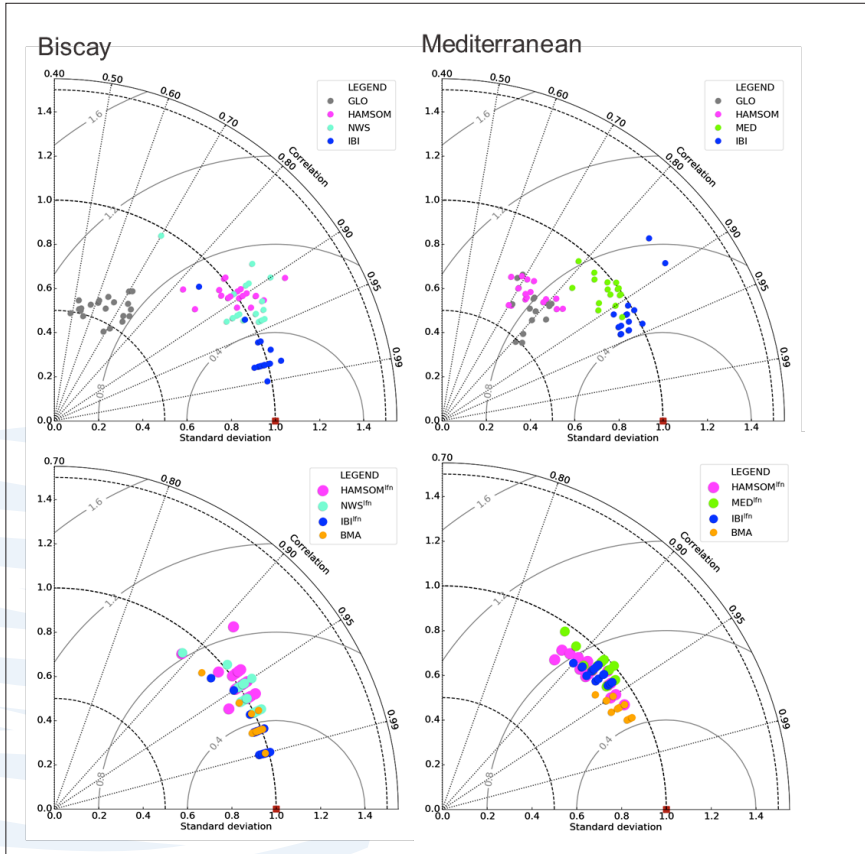

Fig. 2. Taylor Diagram showing correlation, normalized standard deviation and centred root mean square at tide gauge locations in the Biscay (left) and Mediterranean (right) subdomains. Note the different scales in the correlation axis between the top and bottom panels. **TOP:** analysed parameter is residual of the individual forecasts before low frequency nudging. **BOTTOM:** analysed parameter is residual of the individual forecasts included in each BMA after low frequency nudging, and that of the BMA.

5. Summary and conclusions

Inter-comparison of forecasted residuals show how baroclinic models are now outperforming the Nivmar barotropic system. This means that baroclinic models have improved its capability to solve the longer period baroclinic signal, which is introduced in the Nivmar system only after low frequency nudging. Nudging, however, still proves to play an important role in adjusting the imposed low frequency signals in the baroclinic forecasts.

The new BMA joint solution provides a better solution than the individual models in the *Mediterranean* domain. These results mean that it is possible to create a better sea level forecast system and that we are able to obtain a clear advantage from the synergies derived from overlapping in the MFC domains. In the *Biscay* domain, the benefits of integrating all the available regional models is not so clear, and other solutions to the final sea level forecast in the domain should be sought.

Immediate work towards the final implementation of ENSURF includes BMA final tuning in the studied areas and in the Canary Islands, Gibraltar Strait and British Isles/Channel areas. This process entails the study of the impact of incorporating the operational high resolution local models (SAMOA-200m and SAMPA-1km, Fanjul *et al.*, 2017) developed in PdE to the BMA solutions, in locations where these are available.

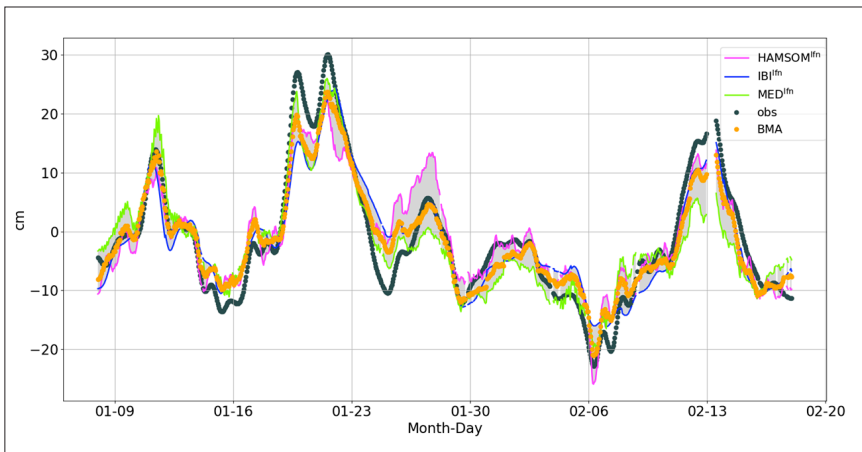

Fig. 3. Mediterranean BMA and individual members residual forecasts (after lfn) for Valencia tide gauge station (January-February 2017).

Acknowledgements

The authors would like to thank the cooperation of the CMEMS Service Desk and the NWS, MED and IBI MFCs together with the InSTAC members. This work has been carried out under the *Spanish Ministry of Economy and Competitivity SOPRANO* project.

References

- Álvarez-Fanjul, E., Pérez-Gómez, B. y Rodríguez Sánchez-Arévalo, I. (2001). Nivmar: A storm surge forecasting system for Spanish Waters. *Scientia Marina*, 65, 145-154.
- Álvarez-Fanjul, E., M. G. Sotillo, B. Pérez-Gómez, J. M. García-Valdecasas, S. Pérez, A. Rodríguez, I. Martínez, Y. Luna, E. Padorno, G. Díaz, J. López, R. Medina, M. Grifoll, M. Espino, M. Mestres, L. Rafols, A. Sánchez-Arcilla (2017). The SAMOA initiative: Operational Oceanography at the service of the Ports. *8th EuroGOOS proceedings*.
- Brink, H., and Allen, J. (1978). On the effect of bottom friction on barotropic motion over the continental shelf. *Journal of Physical Oceanography*, 8, 919-922.
- Bernier, N. B. and Thompson, K.R. (2015). Deterministic and ensemble storm surge prediction for Atlantic Canada with lead times of hours to ten days. *Ocean Modelling*, 86, 114-127.
- Horsburgh, K. J., and C. Wilson (2007). Tide-surge interaction and its role in the distribution of surge residuals in the North Sea, *Journal of Geophysical Research*, 112.
- Müller, M., Cherniawsky, J.Y., Foreman, M.G.G. and von Storch J-S (2014). Seasonal variation of the M2 tide. *Ocean Dynamics*, 64: 159.
- Pérez-Gómez, B., Brower, R., Beckers, J., Paradis, D., Balseiro, C., Lyons, K., Cure, M., Sotillo, M.G., Hackett, B., Verlaan, M. and Alvarez-Fanjul, E. (2012). ENSURF: Multi-model sea level forecast – implementation and validation results for the IBIROOS and Western Mediterranean regions. *Ocean Science*, 8(2), 211-226.

BIO-ARGO AS A POTENTIAL SOURCE OF REGULAR VALIDATION AND MODEL IMPROVEMENT IN AN OPERATIONAL BIOGEO-CHEMICAL MODEL

V. Ç. Yumruktepe and A. Samuelsen

Nansen Environmental and Remote Sensing Centre and Bjerknes Centre for Climate Research, Bergen, Norway

Abstract

In the context of rapid environmental change and its potential impacts on marine ecosystems there is a growing demand for better monitoring and forecasting services. This raises the need for high-resolution products that are corrected with extensive datasets and assimilation techniques that are routinely evaluated. For biogeochemical variables, the primary source has been cruise data, which are not autonomous or available real time. Remote sensed data are limited to the surface and cloud cover. Biogeochemical sensors mounted on BioARGO are a growing source of real time observations. We investigate the potential for using the bio-ARGO observations for evaluation of operational model of North Atlantic and Arctic. The model system uses ECOSMO, a 3d NPZD ecosystem model coupled to HYCOM within TOPAZ4 ocean-sea ice data assimilation system and provides regular forecast for the region north of 62N. Bio-ARGO can have sensors for nitrate, oxygen, chlorophyll, and pH in addition to temperature and salinity. Thus, we can potentially evaluate the quality of information that can be gathered such as the actual values, the shape of the chlorophyll profiles, location of deep chlorophyll maxima and the timing of spring bloom and of initial drawdown of nutrients, in the context of improving model dynamics.

Keywords: BioARGO, model validation, chlorophyll a, ecosystem model, growth limitation

1. Introduction

In the context of rapid environmental change and its potential impacts on marine ecosystems, there is a growing demand for better monitoring and forecasting services. This raises the need for high-resolution products that are corrected with extensive datasets and assimilation techniques that are routinely evaluated. For biogeochemical variables, the primary source has been cruise data, but these are not autonomous or available in real time. Remote sensed data are limited to the surface and by cloud cover. In this context, our objectives are:

- Investigate the potential for using the BioARGO observations for evaluation of an operational model of the North Atlantic and Arctic.
- Improve model estimations of bloom initiation and primary production by model and ARGO data comparisons. Model variables can be evaluated individually by comparing with the observed temporal changes in biogeochemical variables.

2. Materials & methods

BioARGO profiles located north of 50°N in the Atlantic was downloaded from CMEMS database (Fig. 1 and 2). Only ARGOs with real-time correction applied chlorophyll a with “good quality” flag was used (variable name: CPHL-ADJUSTED). TEMP and PSAL data was extracted for ARGO mixed layer depth (MLD) calculations. ARGO data was separated into clusters to create composite time series of chlorophyll a and MLD's. Clustered ARGO data was interpolated to the model points with matching time and depth. We used ECOSMO II coupled to HYCOM (Daewel and Schrum, 2013) to the TOPAZ4 domain (Sakov *et al.*, 2012). The simulated period is 2006–2016, which is a free run forced by ERA-Interim atmospheric forcing with climatology initial and boundary conditions for biological variables. We present years 2013–2016. We evaluated modelled chlorophyll a, phyto- and zooplankton and limitation for growth, particularly for the April–November 2015 period due to high ARGO data temporal resolution (referred to as AREA2).

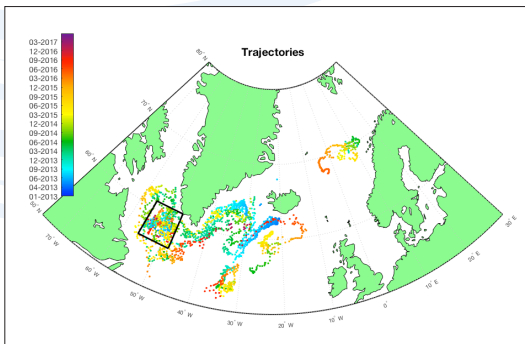

Fig 1. The trajectories with dates color coded of the BioARGOs used in this study. The box represents the area where composite chlorophyll a measurements were prepared for model and BioARGO comparison given in detail in this study.

3. Summary of study results & discussion

Comparison of model vs BioARGO chlorophyll a and MLD's (Fig. 3) suggest that spring bloom commences significantly later in the model than observed, thus, model predicts underestimated chlorophyll a concentrations for April/May, followed by overestimated concentrations in June. This is due to the mismatch of the timing in MLD shallowing (2-8 weeks). Deeper MLDs limit light for phytoplankton growth, leading to late bloom in simulations. These results, along with the comparisons conducted in other areas defined in the trajectory map given in Fig. 1 (comparisons for the other areas defined in this study not shown) point out that in order to better represent bloom initiation in the subpolar/polar Atlantic, model physics and its turbulence dynamics have to be improved. Detail mapping of time vs depth chlorophyll a from BioARGO can provide the necessary information to validate the model physics.

In parallel to spring bloom, model chlorophyll a also show discrepancies with the BioARGO chlorophyll a with significantly higher errors within 25–50m depth range, which the modeled chlorophyll a concentrations are lower than observed throughout the Fall. The model chlorophyll a error compared to BioARGO for Area2 subdomain is given in Fig. 4a, with possible limitation on growth (Fig. 4b). We emphasize the biological terms and limitations in the case of errors in Fall, because modeled MLDs match the observed well in this time period (Fig. 3), pointing that the biological parameterization and growth/prey dynamics were unable to capture the changes in observed chlorophyll a. Main advantage of using BioARGO data in this case is the data provided at depth, where concentration differences in surface and water column chlorophyll a is detectable (Fig. 4a), which is impossible to capture with satellites. We can thus speculate on the reasons for model mismatch with the observations separately for the surface and depth.

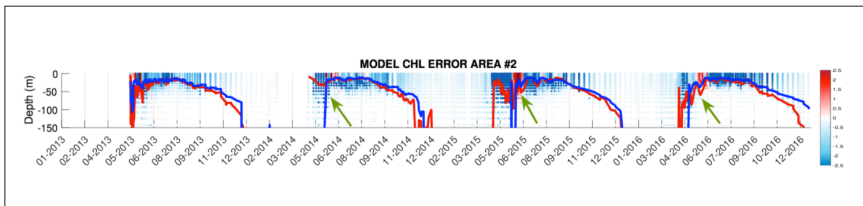

Fig 3. Simulated chlorophyll a ($\mu\text{grams L}^{-1}$) error (model – ARGO data) of composite time series for Area2 defined in Fig. 1. Plotted errors were limited to 0 ± 2.5 range. Lines denote the MLDs estimated from temperature and salinity with the 0.03 density change from 10m depth criteria for both ARGO (red) and model (blue). Green arrows indicate the incidents where model estimates the initiation of stratification later then the ARGO floats which lead to underestimated chlorophyll a with late bloom initiation time.

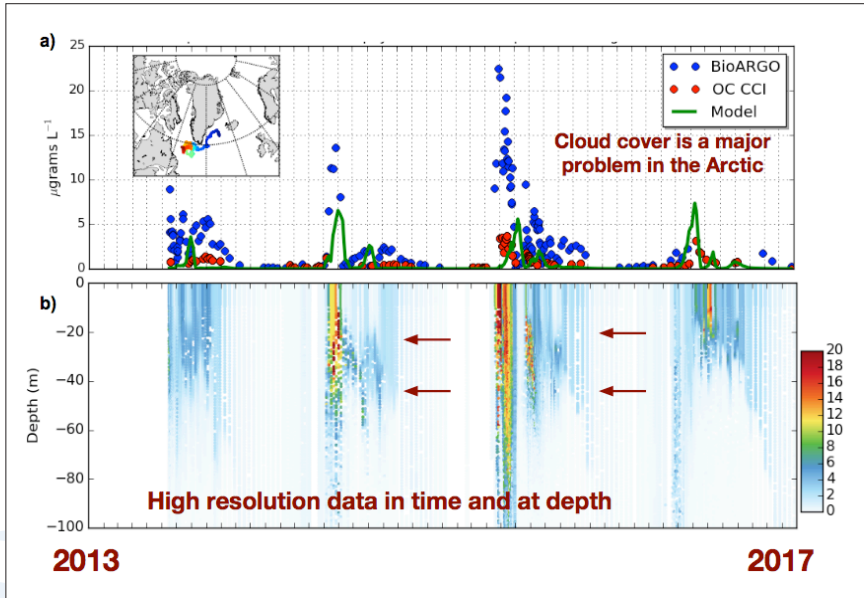

Fig 2. a) An example BioARGO (no: 6901486) trajectory and recorded chlorophyll a. a) Surface chlorophyll a from BioARGO (blue), OC CCI daily chlorophyll a products (red), and modeled chlorophyll a (green) matching the location and time of BioARGO measurements. b) The chlorophyll a profile recorded by BioARGO along its trajectory matching the location and time of the surface measurements.

Model results point out that (not shown here) diatoms dominate spring bloom. Flagellates sustain growth in summer period. Mesozooplankton is the dominant grazer responding to the diatom bloom starting July. Microzooplankton has a minor contribution to grazer biomass in June and August. As Fig. 4b suggest, growth is mainly limited by light. Phytoplankton shading effect is evident in May/June and late July. Diatoms are also limited by silicate availability starting June. There is minor N-limitation in July. Although Si-limited (only for diatoms), absence of nutrient and light limitation suggest that grazing pressure can be the main reason why model underestimates surface chlorophyll a in late June/July. Underestimated subsurface summer chlorophyll a addresses a combination of high light and minor nutrient limitation and grazing pressure.

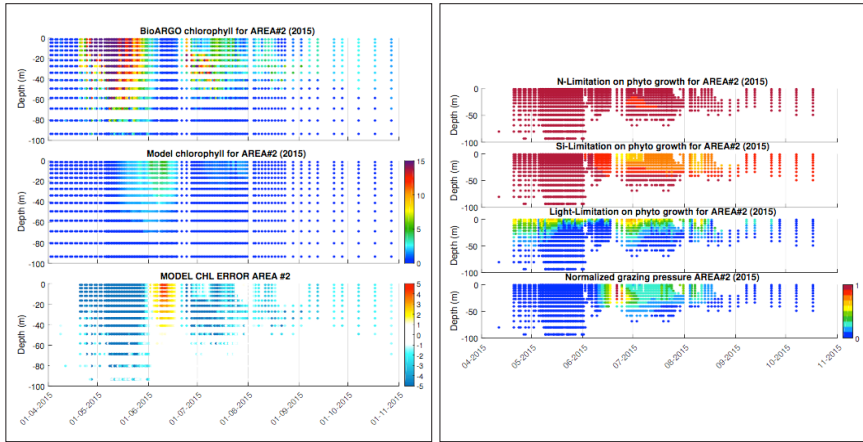

Fig. 4. a) Hovmöller plots of BioARGO and model chlorophyll a ($\mu\text{gms L}^{-1}$) with the resulting error (model–ARGO). Figures focus on the period April 2015 – November 2015 of AREA2 (see poster). b) Model limitation for phytoplankton growth ranging from 0 (limited) to 1 (not limited). Points matching the chlorophyll a errors were plotted. Grazing pressure is normalized to its seasonal maxima (highest=1).

BioARGO provide temporally and more importantly vertically high resolution data for model evaluation, and can contribute to the evaluation of biological model dynamics through evaluating:

- (1) the ecosystem response to seasonal changes in physical structure;
- (2) timing in nutrient limitation and grazing pressure on phytoplankton growth;
- (3) model light attenuation;
- (4) functional type interactions;
- (5) the performance of model formulation and parameterization in representing these.

Comparisons of model and ARGO chlorophyll a demonstrate that fine-tuning of both physics and ecosystem parameters can improve the estimated bloom initiation and seasonal progress of marine production. However, tuning the ecosystem parameters will not fix the late spring bloom initiation caused by late shallowing of the model MLDs. This issue addresses the physics model. Fine-tuning of grazing, light attenuation and prognostic chlorophyll a parameters can significantly improve model ecosystem dynamics. In order to better address the proposed improvements in model parameterization, direct comparisons of model and BioARGO should be improved by regional validation of the BioARGO data with other *in situ* and remotely sensed

data for the Arctic Ocean. This is a follow up work for this study. Once the corrections applied specific to the Arctic, ARGO data can be used for fine tuning ecosystem parameters using data assimilation techniques.

Acknowledgements

ECOSMO II model is being developed in collaboration with the scientists at Helmholtz-Zentrum Geesthacht.

References

- Daewel, U., and Schrum, C. (2013). Simulating long-term dynamics of the coupled North Sea and Baltic Sea ecosystem with ECOSMO II: Model description and validation. *Journal of Marine Systems*, 119-120, 30-49. doi:10.1016/j.jmarsys.2013.03.008
- Sakov, P., Counillon, F., Bertino, L., Lisæter, K. A., Oke, P. R., & Korabely, A. (2012). TOPAZ4: an ocean-sea ice data assimilation system for the North Atlantic and Arctic. *Ocean Science*, 8(4), 633-656. doi:10.5194/os-8-633-2012.



PARTICLE TRANSPORT MODEL SENSITIVITY ON WAVE-INDUCED PROCESSES IN THE FORECASTING COUPLED MODEL SYSTEM

J. Staneva⁽¹⁾, A. Behrens⁽¹⁾, M. Ricker^(1,2), O. Krüger⁽¹⁾, A. Wiese⁽¹⁾, R. Carrasco⁽¹⁾, Ø. Breivik⁽³⁾ and C. Schrum⁽¹⁾

⁽¹⁾ Institute for Coastal Research, HZG, Geesthacht, Germany, E-mail: Joanna.Staneva@hzg.de

⁽²⁾ ICBM, University of Oldenburg, Oldenburg, Germany

⁽³⁾ Norwegian Meteorological Institute and Geophysical Institute, University of Bergen, Norway

Abstract

Different effects of wind waves on the hydrodynamics in the North Sea Baltic Sea are investigated using a coupled wave (WAM) and circulation (NEMO) model system as part of the Geestacht Coupled cOastal model SysTEm GCOAST. The terms accounting for the wave-current interaction are: the Stokes-Coriolis force, the sea-state dependent momentum and energy flux and their role on particle -drift model simulations is investigated. Those particles can be considered as simple representations of either oil fractions, or fish larvae. In the ocean circulation models the momentum flux from the atmosphere, which is related to the wind speed, is passed directly to the ocean and this is controlled by the drag coefficient. However, in the real ocean, the waves also play the role of a reservoir for momentum and energy because different amounts of the momentum flux from the atmosphere is taken up by the waves. In the coupled model system the momentum transferred into the ocean model is estimated as the fraction of the total flux that goes directly to the currents plus the momentum lost from wave dissipation. Additionally, we demonstrate that the wave -induced Stokes Coriolis force leads to a deflection of the current. During extreme events the Stokes velocity is comparable in magnitude to the current velocity. The resulting wave -induced drift is crucial for the transport of particles in the upper ocean. The performed sensitivity analyses demonstrate that the model skill depends on the chosen processes. The use of a coupled model system reveals that the newly introduced wave effects are important for the operational drift -model performance and search and rescue, oil-spill, transport of biological material, or larval drift applications.

Keywords: Particle transport model; coupled wave-circulation model; coastal processes; operational oceanography

1. Methods

1.1 Drifter data

The cruise HE 445 was performed from 18 May to 1 June 2015. The FS Heincke deployed 9 Albatros drifters (see Fig. 1) corresponding to two different models MD03i (Drifters 1 to 6) and ODi (drifters 7 to 9). The drifters provided the current position by Global Positioning System (GPS) which were transmitted to the FS Heincke via Iridium (bidirectional satellite communication network). A sail (0.5m length and diameter) was attached to every drifter to enhance the drag below the water surface. The sail was 0.5 meters under the water surface. Due to the very small drifter surface above the water, compared to the sail surface below the water, the drifter's paths represent the current in the upper meter of the water column.

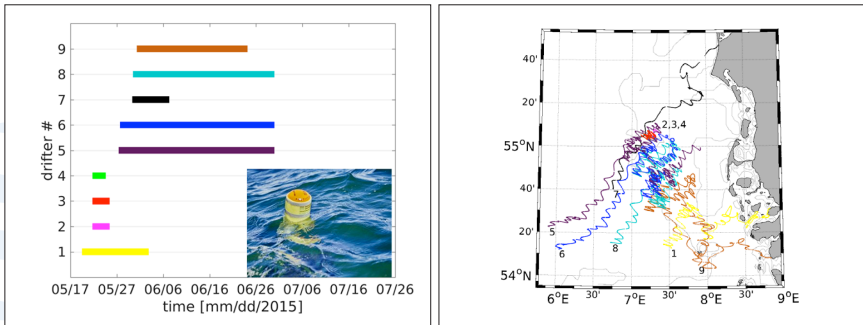

Fig. 1. Left: Deployment of HZG drifters; Right: HZG Drifter trajectories in the North Sea.

1.2 Models

The Circulation model NEMO (Nucleus for European Modelling of the Ocean) v3.6 is a framework of ocean related computing engines, from which we use the OPA package (for the ocean dynamics and thermodynamics) and the LIM-3 sea-ice dynamics and thermodynamics package. The wave model WAM (The WAMDI group, 1988; ECMWF, 2014) is a third-generation wave model, which solves the action balance equation without any a priori restriction on the evolution of spectrum. The last release of the third generation wave model is WAM Cycle 4.5.4. (Staneva *et al.*, 2017). The NEMO ocean model has been modified to take into account the following wave effects (Breyvik *et al.*, 2016; Alari *et al.*, 2017 and Staneva *et al.*, 2017): (1) The Stokes-Coriolis forcing (2) Sea state dependent momentum flux; and (3) Sea state dependent energy flux. OpenDrift (Dagestad *et al.*, 2017) is a freely available open-source off-line Lagrangian model, which contains several modules for the advection of e.g. oil spills, larvae and passive tracers. For this study the passive tracer module is used which advects tracers

only due to currents and winds. The sea and wind currents input is described in the next section. The patterns with time series of the distance between the observed and model drifter #5 trajectories and the trajectories of the different experiments (Fig. 2) demonstrate clearly the improvements of the particle transport model predictions by the coupling between wave and circulation models compared to the stand-alone circulation model.

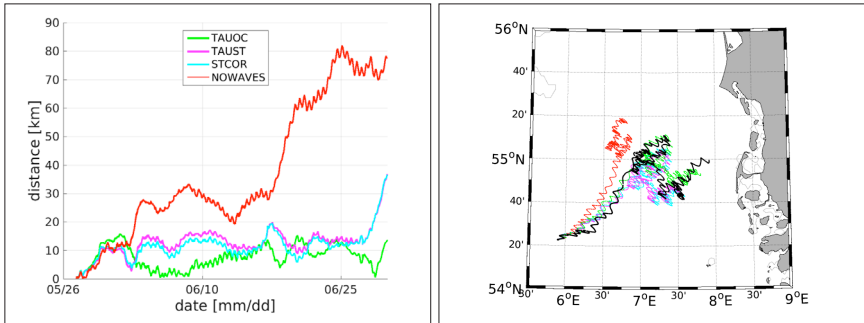

Fig. 2: Left: Time series of the distance (km) between the observed and model drifter #5 trajectories. Middle: Drifter#5 (see Fig.1) trajectories: observed (black line) and modelled (the colours of the different experiments are given in the legend on the left panel; The name of the model experiments in the legend is explained in the Table below.

	NEMO	STOKES-CORIALIS FORCE	SEA-STATE DEPENDENT MOMENTUM FLUX	WAVE BREAKING
CTRL	✓			
STCOR	✓	✓		
TAUOC	✓		✓	
TKE	✓			✓
TAUST	✓	✓	✓	
ALL	✓	✓	✓	✓

2. Discussion

The analyses of modelling results and available observations reveal a closer match with observations for the circulation model forced by sea state dependent fluxes and Stokes-Coriolis force, especially during extreme events. The performed sensitivity analyses demonstrate that the model skill depends on the chosen processes. The use of a coupled model system reveals that the newly introduced wave effects are important for the drift-model performance, especially during extremes. Those processes cannot be neglected by search and rescue, oil-spill, transport of biological material, or larval drift modelling.

Acknowledgements

This study has received funding from the European Union's H2020 Grant Agreement N°: H2020-EO-2016-730030- CEASELESS. A part of this work was supported by CMEMS COPERNICUS Grant WAVE2NEMO.

References

- Alari V., Staneva J., Breivik O., Bidlot J.R., Mogensen K. and Janssen PAEM (2016). Response of water temperature to surface wave effects in the Baltic Sea: simulations with the coupled NEMO-WAM model. *Ocean Dynamics*, DOI 10.1007/s10236-016-0963-x
- Breivik, O., J-R. Bidlot, P. A. Janssen (2016). A Stokes drift approximation based on the Phillips spectrum, *Ocean Modelling*, 100, pp 49-56, doi:10.1016/j.ocemod.2016.01.005
- Dagestad F., J. Röhrs, Ø. Breivik and B. Ådlandsvik (2017) OpenDrift v1.0: a generic framework for trajectory modelling, *Geosci. Model Development Discuss.*, <https://doi.org/10.5194/gmd-2017-205>
- Janssen, PAEM, Breivik, O., Mogensen, K., Vitart, F., Balmaseda, M., Bidlot, J-R., Keeley, S., Leutbecher, M., Magnusson, L., Molteni, F., (2013) Air-sea interaction and surface waves, ECMWF, *Technical Memorandum*. 712, 34 pp
- Staneva J., Alari V., Breivik O, Bidlot J.-R. and Mogensen K., (2016). Effects of wave-induced forcing on a circulation model of the North Sea. *Ocean Dynamics*, DOI 10.1007/s10236-016-1009

ANALYSIS OF BIOCHEMICAL TIME SERIES FROM RADMED MONITORING PROGRAM AT IEO

M.C. García-Martínez⁽¹⁾, M. Vargas-Yáñez⁽¹⁾, F. Moya⁽¹⁾, J.L. López-Jurado⁽²⁾, M. Serra⁽²⁾, R. Santiago⁽²⁾, A. Aparicio⁽²⁾, E. Tel⁽³⁾, J.A Jiménez⁽²⁾ and R. Balbín⁽²⁾

⁽¹⁾ Centro Oceanográfico de Málaga, Puerto Pesquero s/n. 29640, Fuengirola
mcarmen.garcia@ieo.es

⁽²⁾ Centro Oceanográfico de Baleares, Muelle de Poniente s/n, 07015 Palma

⁽³⁾ IEO, Servicios Centrales. C/ Corazón de María, 8. 28002 Madrid

Abstract

Since 2007, the Spanish Institute of Oceanography (IEO) is supporting a Mediterranean monitoring program (RADMED) that is the result of merging four previous monitoring projects, some of them starting in 1992, and the inclusion of new transects never sampled before. Four times per year several sections are sampled routinely, from Cabo Pino (close to Straits of Gibraltar) to Barcelona, including Balearic channels. Coastal, shelf and deep stations are monitored, from 20 to 2500m depth. In this work, all nutrients, chlorophyll and oxygen data collected are analyzed to establish seasonal and spatial patterns. In some cases, as in Cabo Pino or Malaga transects, a total of 67 surveys from 1992 to 2016, have been analyzed. In other sections, as Mahon (westernmost Balearic Island), only data from 17 surveys (2007-2015) are available. Nutricline depth, maximum chlorophyll concentration and maximum chlorophyll depth are also studied. Different patterns are detected depending on the geographical area.

Keywords: Biogeochemical parameters, Inorganic Nutrients, Chlorophyll a, Western Mediterranean, Ocean Monitoring

1. Materials and methods

In this work, data series from RADMED monitoring program (López-Jurado *et al.*, 2015; Tel *et al.*, 2016) were carefully debugged, being all anomalous data eliminated and cleaned up of duplicates. All oxygen data, both from Niskin bottles sampling and CTD casts were combined to have only one set of DO (dissolved oxygen) data. For all the biochemical variables studied (nitrate, nitrite, phosphate, silicate, chlorophyll a and dissolved oxygen), vertical profiles were linearly interpolated every five meters to have a complete profile of each of them and mean values were also calculated (one mean profile value per season: winter, spring, summer and fall at sampling depths). Mean derived variables of each station were also calculated: integrated nutrients, chlorophyll a and oxygen (up to 100m depth), nutricline and deep chlorophyll maximum depth, maximum chlorophyll concentration, maximum and minimum oxygen concentrations and depths (Table I).

2. Results

Fig. 1 shows the seasonal mean maximum chlorophyll concentration (mg/m^3), DCM (Dissolved chlorophyll maximum) depth (m) (in brackets) and integrated chlorophyll (mg/m^2). Maximum chlorophyll concentration and integrated chlorophyll decrease from westernmost part of Alboran Sea to Northwestern region, while DCM depth follows the opposite pattern, decreases from west to east. DCM is generally higher in the vicinities of Strait of Gibraltar. The highest annual DCM value is one of the shallowest (10m) of the year, and appears in spring in P4 station (2 mg/m^3), and the lowest in fall in T4 and B1 stations (0.1 mg/m^3), at 35 and 17m, respectively.

An annual cycle can be described as follows: annual maximum DCM concentration is found in winter, a slight decrease in spring (with some exceptions, mainly in western Alboran Sea), and continues decreasing in summer and fall when DCM is minimum. By contrast, DCM depth reaches the lowest values in winter, increases in spring and achieves maximum annual values in summer.

When comparing DCM concentration of shallower stations (2) with deeper ones (4) there are no important differences between them in winter (Fig. 1), except in Tarragona, where ranges from 0.8 mg/m^3 at T2 to 0.5 mg/m^3 at T4 station, showing a decreasing coast-offshore gradient. The DCM concentration in the rest of studied transects remains almost constant, may be due to winter mixing. On the other hand, in spring, there's a decreasing gradient from coast to offshore, mainly in Alboran Sea that can be due to upwelling phenomena. As an example, at V2 (Velez) DCM reaches 1.6 mg/m^3 , being reduced to 1 mg/m^3 in V4 station, being deeper in the offshore station (38m) than in the shallow one (24m). The only exception is again in the Northwestern area, in Barcelona 0.3 mg/m^3 in BNA2 and 0.8 mg/m^3 in BNA4. In summer, no noticeable gradients are found in any transect. Only decreases DCM concentration from station 2 to 4 in Cabo Pino (P), and increases in Malaga (M). On the contrary, in fall the offshore stations show higher DCM concentration in all transects, except in Cabo Pino and Malaga (the area most influenced by Atlantic inflow).

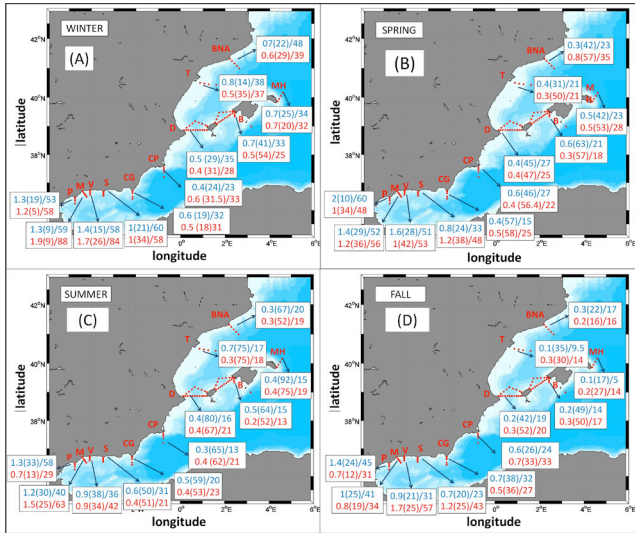

Fig. 1. Seasonal averaged maximum chlorophyll concentration (mg/m^3)/ maximum chlorophyll depth (m) (in brackets)/ integrated chlorophyll (mg/m^2) (0-100m or 0-bottom depending on the station dept). In blue, data corresponding to platform stations, in red slope or deep waters stations.

3. Conclusions

The temporal and spatial extensions of RADMED sampling strategy permits the observation of different oceanographic events in all seasons, and in successive years, allowing the discrimination between different sources of temporal variability. RADMED time series are a valuable tool for assessing the mean or average biochemical conditions along the continental shelf and slope, as well as long term trends and changes (not shown in this work).

Table I. Seasonal mean integrated Oxygen, Nitrogen (as sum of nitrate and nitrite), Phosphate, Silicate and Chlorophyll at selected stations. P2 and P4 correspond to the westernmost transect sampled in Alboran Sea. BNA2 and BNA4 belong to Barcelona transect (Northwestern Spanish Mediterranean)

P2 (130M)	WINTER	SPRING	SUMMER	FALL
oxygen (l/m ²)	485,9 ± 40,5	470,5 ± 45,5	464,3 ± 53,6	466,7 ± 39,4
N (mmol/m ²)	285,3 ± 111,1	404,1 ± 120,0	352,4 ± 153,1	401,9 ± 161,4
P04 (mmol/m ²)	18,7 ± 6,5	23,7 ± 8,4	20,7 ± 7,8	23,8 ± 8,1
SiO4 (mmol/m ²)	223,0 ± 81,0	239,4 ± 89,4	253,0 ± 72,1	261,9 ± 81,0
chl _a (mg/m ²)	53,1 ± 30,8	60,5 ± 26,7	58,2 ± 28,4	44,9 ± 21,8
P4 (870M)	WINTER	SPRING	SUMMER	FALL
oxygen (l/m ²)	471,8 ± 24,1	442,9 ± 61,3	444,2 ± 39,4	471,9 ± 34,7
N (mmol/m ²)	394,3 ± 30,5	513,6 ± 33,5	322,4 ± 153,1	456,7 ± 173,2
P04 (mmol/m ²)	19,9 ± 2,7	41,6 ± 10,6	18,8 ± 0,5	29,5 ± 9,3
SiO4 (mmol/m ²)	238,0 ± 42,5	235,9 ± 63,7	200,2 ± 40,6	316,4 ± 81,0
chl _a (mg/m ²)	58,4 ± 58,7	47,9 ± 23,7	29,1 ± 3,0	31,3 ± 15,0
BNA2 (295M)	WINTER	SPRING	SUMMER	FALL
oxygen (l/m ²)	548,2 ± 28,0	499,6 ± 47,7	490,6 ± 57,4	531,3 ± 41,8
N (mmol/m ²)	96,6 ± 23,9	95,2 ± 34,1	55,7 ± 23,0	104,1 ± 40,4
P04 (mmol/m ²)	2,6 ± 0,2	2,4 ± 0,7	4,4 ± 1,7	4,1 ± 2,1
SiO4 (mmol/m ²)	89,4 ± 17,2	111,1 ± 22,8	82,2 ± 11,0	127,6 ± 24,0
chl _a (mg/m ²)	48,3 ± 21,0	22,8 ± 9,0	20,3 ± 3,3	17,5 ± 7,1
BNA4 (1320M)	WINTER	SPRING	SUMMER	FALL
oxygen (l/m ²)	511,3 ± 36,9	490,7 ± 46,5	488,2 ± 59,1	532,7 ± 53,2
N (mmol/m ²)	184,2 ± 29,4	114,3 ± 59,2	137,5 ± 28,2	61,2 ± 40,6
P04 (mmol/m ²)	4,7 ± 0,6	3,4 ± 0,6	9,1 ± 0,4	3,3 ± 1,1
SiO4 (mmol/m ²)	175,5 ± 21,1	202,7 ± 28,6	132,7 ± 19,3	117,7 ± 25,7
chl _a (mg/m ²)	39,4 ± 11,7	34,7 ± 16,0	19,2 ± 5,3	15,8 ± 2,9

References

López-Jurado, J. L., Balbín, R., Alemany, F, Amengual, B., Aparicio-González, A., Fernández de Puelles, M. L.,García-Martínez, M. L., Gazá, M., Jansá,J., Morillas-Keiffer, A., Moya, F, Santiago, R., Serra, M., Vargas-Yáñez, M. (2015) The RADMED monitoring program as a tool for MSFD implementation: towards an ecosystem-based approach. *Ocean Science* 11, 897-908. doi:10.5194/os-11-897-2015.

Tel, E., Balbin, R., Cabanas, J. M., Garcia, M. J., Garcia-Martinez, M. C., González-Pola, C., Lavín, A., López-Jurado, J.L., Rodriguez, C., Ruiz-Villarreal, M., Sánchez-Leal, R. F., Vargas-Yáñez, M., and Pérez-Belchí, P. (2016) IEOOS: The Spanish Institute of Oceanography Observing System. *Ocean Science* Vol 12(345-353) doi:10.5194/os-12-345-2016

**DATA, PRODUCTS
AND SERVICES**



THE SAMOA INITIATIVE: OPERATIONAL OCEANOGRAPHY AT THE SERVICE OF THE PORTS

E. Álvarez Fanjul⁽¹⁾, M. García Sotillo⁽¹⁾, B. Pérez Gómez⁽¹⁾, J. M. García Valdecasas⁽¹⁾, S. Pérez Rubio⁽¹⁾, Á. Rodríguez Dapena⁽¹⁾, I. Martínez Marco⁽²⁾, Y. Luna⁽²⁾, E. Padorno⁽²⁾, I. Santos Atienza⁽²⁾, G. Díaz Hernandez⁽³⁾, J. López Lara⁽³⁾, R. Medina⁽³⁾, M. Grifoll⁽⁴⁾, M. Espino⁽⁴⁾, M. Mestres⁽⁴⁾, P. Cerralbo⁽⁴⁾ and A. Sánchez Arcilla⁽⁴⁾

⁽¹⁾ Puertos el Estado. enrique@puertos.es

⁽²⁾ AEMET

⁽³⁾ IH Cantabria

⁽⁴⁾ LIM-UPC

Abstract

SAMOA is a revolution in the way solutions are provided to the Operational Oceanography needs of the Port Authorities. An integrated system, ultimately based on CMEMS data, has been developed. A total of 10 new high-resolution atmospheric models (1km resolution, based on Harmonie), 10 wave models (5 m., mild slope model) and 9 circulation models (70 m., ROMS) have been developed and operationally implemented. In terms of instrumentation, SAMOA improved the already existing large network of Puertos del Estado by means of 13 new meteorological stations and 3 GNSS associated to the tide gauges. 25 Ports from 18 Port Authorities will benefit from these new modeling and monitoring advances.

Keywords: Alert, Port, Circulation, Oil Spill. Wind, Waves, Downstream, CMEMS

1. Introduction

Approximately 85% of total imports and 60% of Spanish exports are channeled through ports, a fact that speaks for itself of the vital role they play in the national economy.

The ports suffer the extreme events of the essential physical variables, specially wind, waves and sea level. These affects the installations during all phases of the harbor life, from design to operation. To respond to these complex needs. the SAMOA initiative (System of Meteorological and Oceanographic Support for Port Authorities) was born, co-financed by Puertos del Estado and the Port Authorities.

All previously existing and new products are fully integrated in a specific visualization tool that is being managed by administrators in the harbors. In addition, there is a new alert system via e-mail and SMS, fully configurable by the users in the Port community. Finally, an extended set of applications, such as oil spill models and air pollution monitoring tools, have been fully integrated into the system.

Amongst others, the uses of the system are: 1) provision of information for knowledge based operation of infrastructures (i.e. forecast of Port closing due to extreme events); 2) aid for pilot operations; 3) safer and more efficient port operations (i.e. crane operations affected by winds, planning of Ro-Ro operations); 4) Fight against oil spills in the interior of the harbours and 5) Control of water and air quality.

SAMOA is based on the developments of the SAMPA project, developed with the Algeciras Port authority, that in the present framework played the role of laboratory of the Spanish Port System. SAMOA has been co-financed by the Spanish Ports (75%) and by Puertos del Estado (25%).

2. The monitoring component

SAMOA relies heavily on previously existing Puertos del Estado monitoring networks (25 buoys, 8 HF radars and 40 tide gauges). In this sense, SAMOA has been used to fill detected gaps, improving the coverage of meteorological stations on the Ports and the control of the tide gauges by means of continuous GNSS systems.

3. The atmospheric component

SAMOA Meteorological component aims to provide a high-resolution forecast for surface weather variables, especially winds, over harbour areas. This can be fulfilled using a new configuration and integration of the HARMONIE-AROME model running semi-operationally at 1.0km resolution over the Ports of Almería, Aviles, Baleares, Barcelona, Gijón, Las Palmas, Málaga, Melilla, Tenerife and Tarragona.

HARMONIE (Hirlam-Aladin Research On Mesoscale Operational NWP In Europe) is a spectral Bi-Fourier limited area numerical weather prediction (NWP) model. The main features of the model deterministic system are a thorough data assimilation (Brousseau et al. 2011) and surface treatment, a non-hydrostatic dynamics core with Semi-Lagrangian semi-implicit discretization over the horizontal grid and hybrid coordinate on the vertical and in continuous evolution parametrizations for sub-grid scale physical processes. The AROME implementation (Seity et al. 2011) is designed for high resolution, 2.5km by default, including new parametrizations like convection or solar radiation, but can be forced to reach higher horizontal resolutions providing even better results. Running HARMONIE-AROME at the very high resolution of 1.0km implies facing several challenges. Numerical time step is adjusted to 30 seconds to keep a continuous air flow without overloading computational resources. Topography is based on Global Multi-resolution Terrain Elevation Data (GMTED2010) (Danielson

and Gesch. 2011), a global Digital Elevation Model with 250 meters resolution, appropriate to generate a smooth and realistic field through upscaling without introducing orographic noise. The boundary conditions are obtained from the 0.1 degrees resolution IFS model from ECMWF as it proved better results than using an intermediate HARMONIE-AROME model of 2.5 km.

The model runs twice per day, at 00 UTC and 12 UTC, with a forecast length of 48 hours over the areas of interest on ECMWF supercomputer. The obtained results show much richer dynamics than the AEMET official 2.5km forecast (Fig. 1), capturing smaller eddies and more local behaviors. The quantitative verification, performed with the MONITOR tool developed by HIRLAM, shows an improvement of the statistical scores for the highest resolution model wind forecast both at deep convection episodes and long-term periods over the four main areas. However, several issues are still open for very high-resolution mesoscale models, like the use of a more suitable verification method, an adequate data assimilation or the continuous improvement of forecast accuracy through better physical parametrizations and numerical and computational strategies.

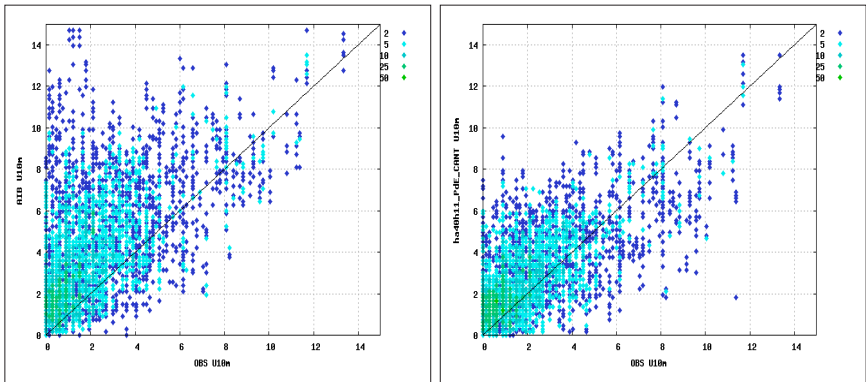

Fig. 1. Validation over the Gulf of Biscay area: Scatter plot of 10m wind observations against operational 2.5km HARMONIE-AROME on the left and against new 1.0km HARMONIE-AROME on the right.

4. The circulation component

The SAMOA circulation component produce, on a daily basis, a short term (3-days) forecast of 3D currents and other oceanographic variables, such as temperature, salinity, and sea level for 9 Spanish ports in the Mediterranean (Barcelona, Tarragona, Almeria), the Iberian Atlantic (Bilbao, Ferrol) and the Canaries (Las Palmas, Tenerife, La Gomera, and Santa Cruz de la Palma).

The three-dimensional hydrodynamic model used in the SAMOA circulation systems is the Regional Ocean Modeling System (ROMS; Shchepetkin and McWilliams; 2005)). The SAMOA model applications consist of 2 nested regular grids with spatial resolution of ~350m and ~70m for the coastal and harbour domains respectively. The chosen vertical discretization consists in 20 sigma levels for the costal domains (except for the Canary implementations where, due to the deepest bathymetry, 30 levels are used) and 15 levels for the port domains. Bathymetry of the SAMOA coastal systems are built using a combination of bathymetric data from GEBCO (www.gebco.net) and from specific local high-resolution sources provided by local Port authorities.

At the surface, models are forced by daily updated high frequency (hourly) winds and heat and water fluxes from the Spanish Meteorological Agency (AEMET) forecast services. The SAMOA forecast systems are CMEMS downstream services, being the coastal models nested into the regional CMEMS IBI forecast solution. In those ports, where river freshwater discharges may be relevant (i.e. Ferrol, Bilbao, Barcelona and Tarragona).

Prior to the operational launch of the SAMOA systems, the quality of a 1-year of SAMOA coastal and port products have been assessed by comparison of model solutions with observations, both from in situ moorings and remote sensed products. A validation tool is implemented to evaluate the downscaled SAMOA local solutions, using available operational observational sources (both remoted sensed, including HF Radars and in situ). Apart of validating the local solution, the objective of this tool is to evaluate the effectiveness of the dynamical downscaling performed, providing an objective measure of potential added value with respect to the regional Copernicus solutions (in which local models are nested). An example of these potential added value evaluation is shown in Fig. 2.



Fig. 2. Snapshot of the Multi-parametric Ocean Model Skill Assessment tool, implemented by PdE to validate operationally SAMOA downscaled local solutions and to compare them with the “parent” regional solution in which are nested (the CEMES IBI MFC forecast product).

4. The wave component

The SAMOA wave component has been designed to provide a 3-day forecast of agitation (significant wave height in the interior of the Port) inside 10 Spanish ports of special interest: Almeria (2 ports), Gijon, Las Palmas (3 ports), Malaga and Santa Cruz de Tenerife (3 ports). Before SAMOA, Puertos del Estado was running an operational wave forecast able to provide, using SWAN model, wave forecast at the harbours mouth. Thanks to SAMOA developments, now this forecast has been downscaled to the interior of the ports at extremely high resolution (2 meters).

The new system is based on the spectral reconstruction technique of sea states through the use of a monochromatic wave catalogue previously computed in advance by means of a model based on the elliptical approximation of the mild slope equation, including some ad-hoc innovative improvement:

- Updated numerical solver to speed up the simulations (reaching 10x times faster than similar models). Thanks to this development and changes in the meshing tool it is possible to reach the mentioned resolution.
- Introduction of the reflection response algorithm in the numerical contours as a function of the incident wave period and based on the functional response of each type of pier and breakwaters analysed.

Results of the system have been validated calibrated using agitation data measured by the Puertos del Estado tide gauges (Fig. 3). The model output is validated on daily basis with this instrumentation.

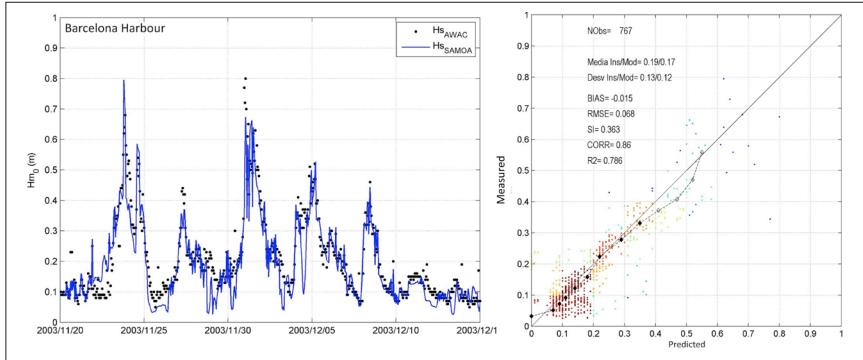

Fig. 3. Example of validation of the operational predictions in the ports of Barcelona, using agitation data provided by the tide gauge.

6. Integration and downstream tools

The SAMOA model outputs are freely accessible through the PdE THREDDS catalogue (OPENDAP, WMS). Likewise, free access to some products is granted via the PdE Portus web interface (<http://portus.puertos.es>). Additionally, a specific tool for the Port Authorities has been developed to exploit properly all SAMOA products, the CMA (Cuadro de Mando Ambiental - see Fig. 4), implemented today in 25 Ports. The CMA is based on a web interface (<http://cma.puertos.es>) and provides an easy access to all the information generated by the SAMOA systems, both in real time and in forecast mode. The user can define thresholds for all spatial points inside the application (model points and measuring stations) that are used to trigger alerts. The CMA is also capable of creating customised pdf-reports for each forecast point.

Additionally, a user-friendly oil spill model and an atmospheric dispersion model have been developed and implemented into the CMA.

Managers at the Ports granted the access to the tool and define the level of permission the users have. For example, some users can get permission for visualization, but might not have access to the oil spill model. In Algeciras harbour, a very good example of how the CMA must be exploited, the community of users inside the Port (including the companies working at the facilities) rises now the number of 250.

The CMA also is employed by the different users to configure the personalised alert system, defining the points and the alerts to be triggered, as well as the reception method (e-mail or SMS). The alerts can be defined as a combination of parameters, conditions and thresholds as complex as desired by the user.

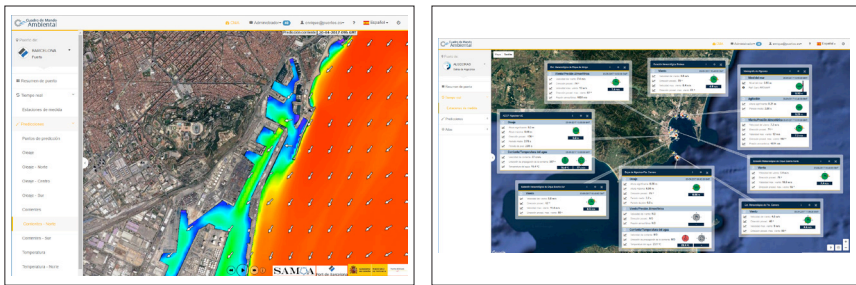

Fig. 4. The SAMOA visualization tool, showing the circulation at Barcelona Port and the real-time measurements at Agciras Harbour.

7. Future plans

Building on the success of SAMOA, a SAMOA 2 project is being launched. This second phase will include new components, such as wave overtopping forecast or extremely high-resolution wind prediction (in the order of meters). In 2020, by the end of SAMOA 2, the system will have the following components: 44 CMA implementations in different Ports (of a total of 46 Ports in the national system), 20 1-km resolution atmospheric forecast, 21 agitation systems, 31 circulation systems, 19 new meteorological stations, 8 GNSS, 15 very high wind forecast systems, plus other additional modules.

Despite these figures, the most important challenge for the Port System is the required global change of methodologies to make extensive use of all the new available tools. Several initiatives will be launched to fulfill this objective, probably the most important of SAMOA.

References

Brousseau P., Berre L., Bouttier F., Desroziers G. (2011). Background-error covariances for a convective-scale data-assimilation system: AROME-France 3D-Var. *Quarterly Journal of the Royal Meteorological Society*, vol. 137, pp. 409-422.

Danielson J., Gesch D. (2011). Global Multi-resolution Terrain Elevation Data 2010 (GMTED2010). U.S. Geological Survey Technical Report, *Open-File Report 2011-1073*, 26 pp

Shchepetkin, A. F., & McWilliams, J. C. (2005). The regional oceanic modeling system (ROMS): a split-explicit, free-surface, topography-following-coordinate oceanic model. *Ocean Modelling*, 9(4), 347-40

Sotillo, M.G., P. Cerralbo, P. Lorente, M. Grifoll, M. Espino, A. Sanchez-Arcilla, E. Álvarez-Fanjul. (2018). High Resolution Coastal Ocean Forecasting in Spanish Ports: The SAMOA Operational Service. Submitted to *Journal of Operational Oceanography*
Brink, H., and Allen, J. (1978). On the effect of bottom friction on barotropic motion over the continental shelf. *Journal of Physical Oceanography*, 8, 919-922.

Seity Y., Brousseau P., Malarden S., Hello G., Bernard P., Bouttier F., Lac C., Masson V. (2011). The AROME-France convective-scale operational model. *Monthly Weather Review*, vol. 139, pp. 976.



HNS-MS: IMPROVING MEMBER STATES PREPAREDNESS TO FACE AN HNS POLLUTION OF THE MARINE SYSTEM

S. Legrand⁽¹⁾, S. Le Floch⁽²⁾, L. Aprin⁽³⁾, V. Partenay⁽⁴⁾, E. Donnay⁽⁵⁾, S. Orsi⁽¹⁾, N. Youdjou⁽¹⁾, R. Schallier⁽¹⁾, F. Poncet⁽²⁾, S. Chataing⁽²⁾, E. Poupon⁽²⁾ and Y.-H. Hellouvy⁽⁴⁾

⁽¹⁾ Royal Belgian Institute of Natural Sciences, Operational Directorate Natural Environment, Gulledele 100, B-1200 Brussels, Belgium. sebastien.legrand@naturalsciences.be

⁽²⁾ CEDRE - Centre de documentation, de recherche et d'expérimentations sur les pollutions accidentelles des eaux. 715 rue Alain Colas - CS 41836 29218 BREST CEDEX 2 – France

⁽³⁾ ARMINES, Ecole des Mines d'Alès. 6 avenue de Clavières, 30319 Alès cedex, France

⁽⁴⁾ Alyotech France – SCALIAN. Espace Nobel, 2 Allée de Becquerel, 35700 Rennes, France.

⁽⁵⁾ Belgian FPS Health, Food Chain Safety and Environment, DG-Environment, Eurostation II, Victor Hortaplein, 40 bus 10, B-1060 Brussel, Belgium

Abstract

The European project HNS-MS aimed at developing a decision-support system that national maritime authorities and coastguard stations can activate to forecast the drift, fate and behaviour of acute marine pollution by Harmful Noxious Substances (HNS) accidentally or deliberately released in the marine environment. Focussing on the Greater North Sea and Bay of Biscay, the project had four specific objectives:

1. To develop a freely accessible data base documenting the most important HNS transported from or to the ports of Antwerp, Rotterdam, Hamburg, Nantes and Bordeaux;
2. To conduct lab experiments in order to improve the understanding of the physico-chemical behaviour of HNS spilled at sea;
3. To develop a 3D mathematical modelling system that can forecast the drift, fate and (SEBC) behaviours of HNS spilled at sea. Advanced processes such as chemical reactivity, explosions, fire or interaction with sediment were not considered in this first project;
4. To produce environmental and socioeconomic vulnerability maps dedicated to HNS that will help end-users assessing the likely impacts of HNS pollution on the marine environment, human health, marine life, coastal or offshore amenities and other legitimate uses of the sea.

All these contributions have been integrated into a unique web-based decision support system that will help coastguard stations to evaluate the risks for maritime safety, civil protection and marine environment in case of an acute pollution at sea. This tool is presented in this article.

Keywords: chemical pollution, forecast, decision support system, North Sea, Bay of Biscay

1. Introduction

If maritime shipping is undoubtedly a key factor of the worldwide economic growth, the constantly growing fleet of tankers, bulk carriers and ever-increasing size container ships exacerbates the risk of maritime accidents, loss of cargoes and acute maritime pollution. In particular, more than 2,000 harmful or noxious chemical substances (HNS) are regularly shipped in bulk or package forms and can potentially give rise to significant environmental and/or public health impacts in case of spillage in the marine environment.

Until now, preparedness actions at various levels have primarily aimed at classifying the general environmental or public health hazard of an HNS, at developing operational datasheets collating detailed, substance-specific information for responders and covering information needs at the first stage of an incident or at performing a risk analysis of HNS transported in European marine regions. However, contrary to oil pollution preparedness and response tools, only few decision-support systems currently used by Member States authorities (Coastguard agencies or other) integrate 3D models that are able to simulate the drift, fate and behaviour of HNS spills in the marine environment. When they do, they usually rely on black box commercial software or consider simplified or steady-state environmental conditions.

HNS-MS aims at developing a 'one-stop shop' decision-support system (DSS) that is able to predict the drift, fate and behaviour of HNS spills under realistic environmental conditions and at providing key product information to improve the understanding and evaluation of a HNS spill situation in the field and the environmental and safety-related issues at stake (Legrand *et al.*, 2017a). The DSS integrates the following four basic features:

1. Giving access to information on 123 different HNS (760 if synonyms included);
2. Allowing end-users to set-up realistic simulations based on 9 predefined released scenarios;
3. Facilitating the simulations management including sharing, visualisation and commenting;
4. Helping interpreting likely impacts thanks to regional and local seasonal vulnerability maps.

In this article, these four features will be further presented. However, developing such a DSS requested to improve our understanding of the physico-chemical processes that drive the numerous behaviours and fate of HNS spilt in the marine environment. This is the reason why numerous lab experiments have been conducted during the project (Legrand *et al.*, 2017b).

2. Giving access to hns information: The HNS-MS Data base

The OPRC-HNS Protocol 2000 defines hazardous and noxious substances (or HNS) as “any substances other than oil which, if introduced into the marine environment, are likely to create hazards to human health, to harm living resources and marine life, to damage amenities or to interfere with other legitimate uses of the sea”.

This generic definition covers a wide range of chemicals with diverse intrinsic qualities such as toxicity, flammability, corrosiveness, and reactivity with other substances or auto-reactivity. It includes: oil derivatives; liquid substances which are noxious or dangerous; liquefied gases; liquids with flashpoints not exceeding 60 °C; packaged dangerous, harmful and hazardous materials; and solid bulk material with associated chemical hazards.

Acrylonitrile

Description Physico-chemical Behaviour Ecotoxicity Hazards SESAMP profile

Description Top ^

CAS number	107-13-1
UN number	1093
Chemical formula	C ₃ H ₃ N
Accident occurred	Yes
Standard European Behaviour Classification (SEBC)	Dissolver that evaporates (DE)
Notable risks	Oxidizer. Polymerization.

GHS Security Information

Danger

Fig. 1. Screenshot of the HNS-MS database for acrylonitrile (<https://www.hns-ms.eu/result/19>). The tabs facilitate an easy browsing between 90+ elements of information covering 6 main themes. See Legrand et al. (2017e) for more information on how to use HNS-MS tools.

Despite recent initiatives such as MAR-ICE, MAR-CIS, MIDSIS-TROCS or CAMEO..., maritime authorities and responders often report that the easy and timely access to trustful HNS information is still a challenge in case of maritime pollution. To help solving this issue, one of the first achievements of the HNS-MS project is the development of a HNS data-base, specifically designed for marine environmental hazards. A total of 123 relevant HNS – 760 HNS with all synonyms – have been selected taken into account criteria such as frequency of appearance in existing HNS lists and databases, transported volumes from and to the Bonn Agreement area, toxicity, risk (threat for human lives), representation of different SEBC behaviour classes, product data availability and reliability.

Each of the 123 HNS is described by 90+ elements of information covering 6 main themes: Names and regulation information; Physical and chemical properties; Behaviour; Ecotoxicity; GESAMP profile; GHS/CLP hazard and safety profile. **Freely accessible and searchable**, the HNS-MS data base can be consulted from the HNS-MS public website: <https://www.hns-ms.eu/hnsdb/>. The list of all HNS can be consulted at this webpage: <https://www.hns-ms.eu/api/hns/?limit=1000>. In this first project, most of the selected HNS are pure liquid chemical substances.

3. Modelling HNS drift, behaviour and fate

The purpose of the HNS-MS model is to predict the drift, behaviour and fate of harmful and noxious chemical substances spilt in the marine environment for the first hours and days after the spillage in the greater North Sea (also known as the Bonn Agreement area), its Atlantic margin and the Bay of Biscay.

Developing such a model is a threefold challenge because of:

- i. The wide variety of the HNS products (a.o. liquids, solids, gas – in bulk or packaged) and their wide range of physico-chemical properties;
- ii. The wide variety of HNS behaviours at sea involving numerous physico-chemical processes spanning time and space scales ranging from tenths of second to years and from millimetres to hundreds or thousands of kilometres (Fig. 2) ;
- iii. The wide variety of possible accidents and spill release conditions (leaking tank, adverse weather leading to unstable cargo / ship, loss of containers, collisions, capsizing, hull damage, grounding, sinking, danger of fire, explosion, chemical reaction in cargo, ...).

The development of a model that tackles all these issues in a suitable way will surely remain a long lasting research topic for the coming decade(s). In this relatively short (2-year) project, several acceptable simplifications had to be made. The first main simplification consisted in restricting our developments to the case of pure HNS transported in bulk. Focussing on **pure HNS** allowed us to not consider complex processes occurring with HNS mixtures such as weathering and chemical reactions. We considered neither self-reaction processes nor polymerisation processes. The second simplification consisted in not trying to model “instantaneous” violent event and their consequences such as chemical explosion (including combustion and fire) or physical explosion. Finally, the third main simplification consisted in not considering the interaction between HNS and sediments, neither in the water column nor at the seabed. However, these interactions might have some effect on the fate of HNS spilt in coastal and estuarine turbid areas, such as for instance the Belgian part of the North Sea.

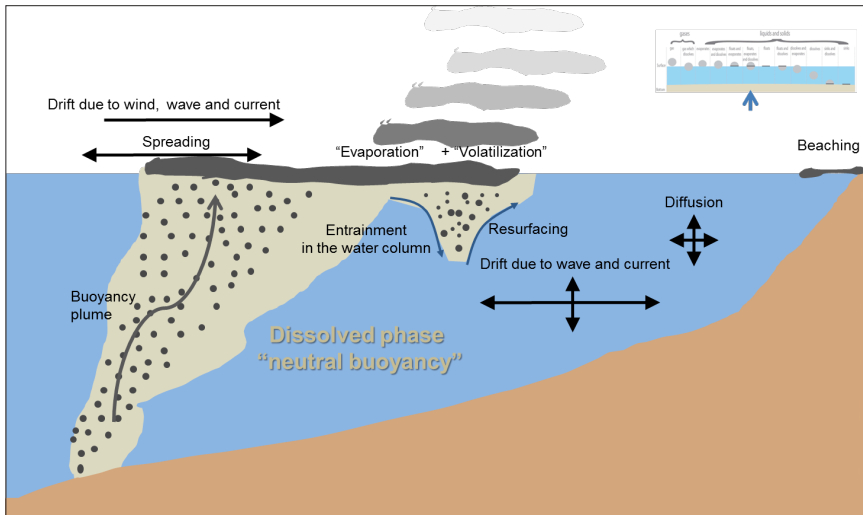

Fig. 2. Schematic view of the main physico-chemical processes influencing the drift, fate and behaviour of a Floater-Evaporator-Dissolver liquid HNS - case of a spillage from a subsurface source, these processes include drift (advection) due to current, waves and wind, dilution due to turbulent mixing, vertical (upward or downward) slip velocity due to buoyancy, resurfacing, natural entrainment in the water column due to surface agitation (waves), beaching, sinking to the seabed, evaporation, volatilisation...

Taking into account these constraints and simplifications, 3 different but linked models (Fig. 3) have been developed in the framework of the project:

1. ChemSPELL, as a near-field model, mainly aiming at modelling processes occurring at small time and space scales, from a few seconds to an hour and from a few meters to a few kilometres away from the source;
2. ChemDRIFT, as a far-field model, mainly aiming at modelling processes occurring at larger time and space scales, from hours to a week and from a few hundreds of meters to tens or hundreds of kilometres away from the source;
3. ChemADEL, as a Gaussian puff atmospheric dispersion model.

A comprehensive description of these models as well as the considered spillage scenarios can be found in Legrand *et al.*, (2017c).

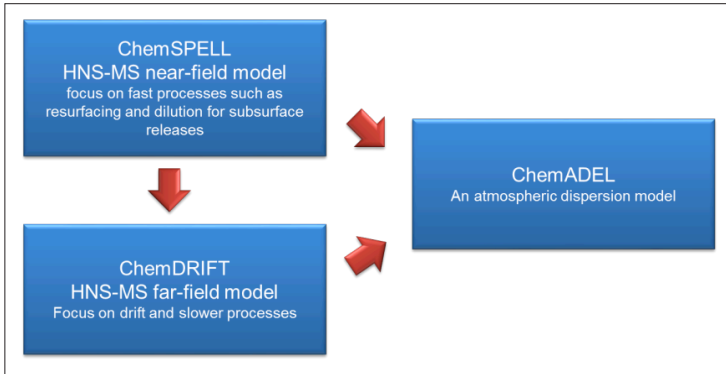

Fig. 3. Three different models have been implemented as a function of time and space scales of the involved processes. The red arrows show how model results of one model can feed the initial conditions of another model.

4. Assessing likely impacts of HNS spills: HNS-MS Vulnerability Maps

The last specific objective of the HNS-MS project is the production of environmental and socioeconomic vulnerability maps useful for assessing the likely impacts of HNS pollution on the most HNS sensitive marine habitats, human health, marine species, coastal or offshore amenities and other legitimate uses of the sea. To this purpose, the methodology developed in the framework of the BE-AWARE projects for oil spill vulnerability mapping was adapted and extended to HNS spill scenarios (Legrand *et al.*, 2017d). The vulnerability analysis was conducted at the regional scale suitable for risk analysis on the Bonn Agreement area and at a local operational scale - the waters and coastline of Belgium being chosen as a test area in the latter case.

A total of 72 maps were produced: 39 vulnerability maps at regional scale for the Bonn Agreement area, 3 thematic maps at local operational scale for Belgium and 32 vulnerability maps at local operational scale for Belgium. The vulnerability maps catalogue with viewing and downloading facilities is available on the HNS-MS public website: https://www.hns-ms.eu/tools/vulnerability_maps.

5. Conclusion and future perspectives

Focussing on the Greater North Sea and Bay of Biscay, the HSN-MS consortium has developed a Decision Support System (Fig. 4) that, once stamped as operational, will help maritime authorities, coastguard stations and responders to evaluate the risks for maritime safety, civil protection and marine environment in case of acute HNS maritime pollution.

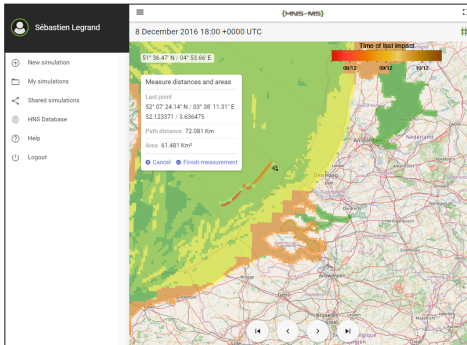

Fig. 4. Screenshot of the HNS-MS decision support system.

Owing HNS-MS achievements, the HNS-MS consortium has solid basis to tackle the many remaining challenges, issues and knowledge gaps that shall be addressed for the coming years and decade(s). Depending on funding opportunities, our priority follow-up actions are the realisation of an extended validation of the HNS-MS model against field data and/or the realisation of inter-comparison studies with similar tools; the long term maintenance and extension of the HNS-MS database, maybe in concertation with EMSA and OSINet; the systematic laboratory characterisation of HNS for non-standard temperature and salinity conditions; further development of models to include advanced processes such as weathering of HNS mixtures, chemical reactivity or interaction with sediments; production of the operational vulnerability maps for the whole Bonn Agreement area and the other seas were the decision support system will be implemented.

Acknowledgements



The project HNS-MS has been co-financed by EU DG-ECHO under grant agreement ECHO/SUB/2014/693705 – Call for proposals 2014 for prevention and preparedness projects in the field of civil protection and marine pollution.

Met-ocean forcing used by the HNS-MS models comes from ECMWF and CMEMS operational forecast.

References

Legrand S., F. Poncet, L. Aprin, V. Parthenay, E. Donnay, G. Carvalho, S. Chataing-Pariaud, G. Dusserre, V. Gouriou, S. Le Floch, P. Le Guerroue, Y.-H. Hellouvy, F. Heymes, F. Ovidio, S. Orsi, J.Ozer, K. Parmentier, R. Poisvert, E. Poupon, R. Ramel, R. Schallier, P. Slangen, A. Thomas, V. Tsigourakos, M. Van Cappellen and N. Youdjou (2017a) "Improving Member States preparedness to face an HNS pollution of the Marine System - HNS-MS Layman's report", *HNS-MS technical report*, 38 pp.

Legrand S., F. Poncet, L. Aprin, V. Parthenay, E. Donnay, G. Carvalho, S. Chataing-Pariaud, G. Dusserre, V. Gouriou, S. Le Floch, P. Le Guerroue, Y.-H. Hellouvy, F. Heymes, F. Ovidio, S. Orsi, J.Ozer, K. Parmentier, R. Poisvert, E. Poupon, R. Ramel, R. Schallier, P. Slangen, A. Thomas, V. Tsigourakos, M. Van Cappellen and N. Youdjou (2017b) "Understanding HNS behaviour in the marine environment", *HNS-MS final report, part I*, 152 pp.

Legrand S., F. Poncet, L. Aprin, V. Parthenay, E. Donnay, G. Carvalho, S. Chataing-Pariaud, G. Dusserre, V. Gouriou, S. Le Floch, P. Le Guerroue, Y.-H. Hellouvy, F. Heymes, F. Ovidio, S. Orsi, J.Ozer, K. Parmentier, R. Poisvert, E. Poupon, R. Ramel, R. Schallier, P. Slangen, A. Thomas, V. Tsigourakos, M. Van Cappellen and N. Youdjou (2017c) "Modelling drift, behaviour and fate of HNS maritime pollution", *HNS-MS final report, part II*, 104 pp.

Legrand S., F. Poncet, L. Aprin, V. Parthenay, E. Donnay, G. Carvalho, S. Chataing-Pariaud, G. Dusserre, V. Gouriou, S. Le Floch, P. Le Guerroue, Y.-H. Hellouvy, F. Heymes, F. Ovidio, S. Orsi, J.Ozer, K. Parmentier, R. Poisvert, E. Poupon, R. Ramel, R. Schallier, P. Slangen, A. Thomas, V. Tsigourakos, M. Van Cappellen and N. Youdjou (2017d) "Mapping Environmental and Socio-Economic Vulnerability to HNS Maritime Pollution", *HNS-MS final report, part III*, 122 pp.

Legrand S., F. Poncet, L. Aprin, V. Parthenay, E. Donnay, G. Carvalho, S. Chataing-Pariaud, G. Dusserre, V. Gouriou, S. Le Floch, P. Le Guerroue, Y.-H. Hellouvy, F. Heymes, F. Ovidio, S. Orsi, J.Ozer, K. Parmentier, R. Poisvert, E. Poupon, R. Ramel, R. Schallier, P. Slangen, A. Thomas, V. Tsigourakos, M. Van Cappellen and N. Youdjou (2017e) "HNS-MS Decision-Support System User's Guide", *HNS-MS final report, part IV*, 94 pp.

THE COPERNICUS MARINE SERVICE USER UPTAKE PROGRAMME: A WAY TO SHOW THE VALUE ADDED CHAIN TILL THE END USERS

S. Cailleau, G. Chabot, A. De Nucé, C. Derval, E. Durand and D. Obaton

Mercator Ocean, Toulouse, France - innovation_clients@mercator-ocean.fr

Abstract

Every month approximately 250 new subscribers choose to discover products and information of the Copernicus Marine Environment Monitoring Service. This is a real incentive to pursue and boost a strategy built on an open and free service and support the development of downstream services. The users and more specifically “intermediate users” are key to the success of this service.

The development and the implementation of a User Uptake programme should firstly secure the loyalty of users and secondly attract new user communities. Within the User Uptake Mercator Océan aims to reinforce its relationship with its intermediate users, to explain and enhance its service and the services of these key players. This is based on their direct involvement to ease the Copernicus Marine Service use and promote inspiring exemplary cases. This will contribute to the development of the whole chain and will raise new user interest and allow communities to exchange and propose relevant evolutions to the current European service.

A first round of User Uptake calls for tender was published in 2016. It focused on coastal operational downstream services using COPERNICUS MARINE products including services linked to the EU Marine Strategy Framework Directive (www.msfd.eu).

Keywords: COPERNICUS MARINE SERVICE, User Uptake, downstream services, operational services, coastal services, MSFD

1. The Copernicus Marine Service and its user uptake programme

A Delegation Agreement has been signed between the European Commission and Mercator Océan for the **Copernicus Marine Environment Monitoring Service (CMEMS** – marine.copernicus.eu) implementation. The Copernicus Marine Service provides regular and systematic reference information on the physical state and dynamics of the ocean and marine ecosystems for the global ocean and the European regional seas. This free service provides products and information describing the current situation (analysis), the forecast of the situation a few days ahead, and the provision of consistent retrospective data records for recent years (re-analysis).

The Copernicus Marine Service provides a sustainable response to European user needs in four areas of benefits:

- Coastal and marine environment;
- Maritime safety;
- Marine resources;
- Climate, seasonal and weather forecasting.

This Copernicus Marine Service has been operational since May 2015. The excellent user response (+10.000 subscribers today) is a real incentive to pursue and boost a strategy built on open and free service and to support the development of downstream services. The CMEMS users, and more specifically “intermediate users”, who are themselves service providers, are key to the success of the service. They bring expertise and added-value to specialised contracts to boost the existing economic activity.

Through the **User Uptake Programme**, Mercator Océan aims to reinforce its relationship with its intermediate users, to explain and enhance the Copernicus Marine Service and the services of its key players. This is based on their direct involvement in facilitating the use of the Copernicus Marine Service and promoting inspiring and exemplary cases, which will contribute to the development of the whole chain.

In practice, Mercator Océan wishes to identify the successful elements of the service relationship between CMEMS and its users, to display and bring visibility to the services of its users and also shows case the Copernicus Marine Service. The concrete examples will raise awareness and pique the interests of new users and allow communities to discuss specific topics and propose relevant changes to the current European service. This User Uptake component will support the Copernicus Marine Service in all its operations and evolutions and will take the shape of several successive contracts. There is a budget of 1M€/year (2016-2021) for successive calls for tender.

The first User Uptake contracts focus on coastal areas in order to demonstrate users' operational applications on all the coastal CMEMS geographical regions (global ocean and European regional seas) and regarding areas of benefit listed above. Other themes will be addressed in coming stages to continue developing various CMEMS downstream applications.

2. The first round of user uptake contracts

Through the contracts signed after the first series of User Uptake calls for tender and started the 31st March 2017, Mercator Océan has got coastal operational services demonstrations in all the CMEMS geographical areas. These demonstrations contribute to the Marine Strategy Framework Directive (MSFD) or cover the above-mentioned areas of benefits, including sub-categories of water quality, eutrophication, tourism activities and oceanic weather forecasts.

As a result, the 18 selected contracts give successful examples of usefulness of the Copernicus Marine Service and are described in various kind of application in the next paragraphs.

2.1 Marine coastal forecasting

A part of User Uptake activities target marine coastal forecasting downstream services. The SHOM (www.shom.fr), the French Navy, has promoted its web portal data.shom.fr which provides coastal data in Iberia-Biscay-Ireland (IBI) area, which are produced from their coastal models nested into CMEMS products and/or validated with CMEMS products.

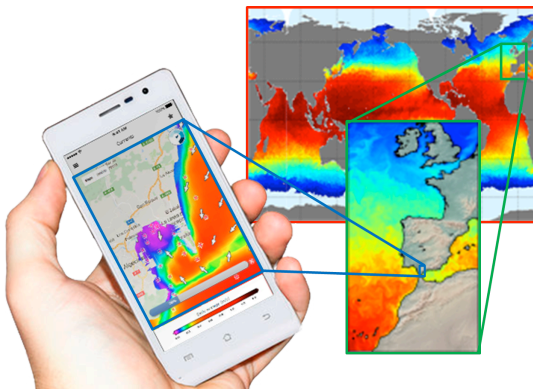

Fig. 1. Downscaling from the CMEMS global ocean forecasting to a local and high resolution model over Algeciras harbour developed by Puertos del Estado (www.puertos.es) and accessible through a smartphone application developed by Nologin (www.nologin.es).

Nologin (www.nologin.es) has developed a mobile application for two harbours authorities (Barcelona and Algeciras) using data from coastal high resolution models nested into CMEMS forecasting products and operated by Puertos Del Estado (SAMPA model). As shown in Fig. 1, this application is an example of the downscaling at 3 levels: from the CMEMS products to the local system at the harbour scale of Puertos del Estado highest resolution coastal models which feeds a useful smartphone application for harbour authorities and developed by Nologin. Finally, **Hidromod** (www.hidromod.com) uses hydrodynamic, waves and weather models to deliver high resolution products nested in Global ocean and IBI CMEMS forecasting information (downscaling) for port operations, oil spill, water quality along the Lisbon, Azores or Madeira coasts.

2.2 Renewable marine energy

Noveltis (www.noveltis.fr) has put forward their *TidEA* application (Tidal Energy Assessment) which is a useful indicator for implementation of coastal tidal technologies such as renewable marine energy.

2.3 Water quality

Water quality issue is well represented after the first round of calls for tender with four contracts. A consortium constituted by **NIMRD** (www.rmri.ro) and **Action Modulers** (www.actionmodulers.com), have developed *iSWIM*, an integrated Service for Water Quality Monitoring in Mamaia bay (Romanian coast). This service consists in a web portal and a mobile application based on a MOHID modelling system forced at open boundaries with CMEMS Black Sea products. **Planetek** (www.planetek.it) provides the *Rheticus*TM Marine operational service in order to monitor the water quality and eutrophication in Italian and Greek coastal areas, by using CMEMS observation data of Mediterranean Sea. **Telespazio** (<http://www.telespazio.fr>) has developed a Predictive and Integrated Coastal Water Quality Management tool dedicated to the water quality in the Basque coast using the CMEMS IBI forecasting and observation products. And finally, **ISPRA** (www.isprambiente.gov.it) has put forward an annual bulletin built from CMEMS model and observation products to support applications of the different EU directives about Marine Environmental State in Mediterranean Sea.

2.4 Marine security and sea ice forecasting

Polar View (www.polarview.org) has put forward a floe edge monitoring service to Greenland Support traditional ways of life in the Arctic. CMEMS Arctic observation products have been used and integrated in the development of a web portal. The **Finnish Meteo Institute** (en.ilmatieteenlaitos.fi) has planned to develop a forecasting service of Baltic Sea landfast ice extension and thickness by using CMEMS Baltic Sea model and observation products.

2.5 Fishery

The Technical University of Denmark (www.dtu.dk) has put forward the *OCEBIS* portal (Ocean Biological Information Service) developed with local biological and

oceanographic forecasts for fishermen and researchers, and using CMEMS North West Shelf forecasts.

2.6 Marine Environment - MSFD

The four last contracts have focused on the Marine Strategy Framework Directive (MSFD). AZTI (www.azti.es) is developing *CHLO4MSFD*, a web portal on satellite-derived chlorophyll *a* (Chl-*a*) products for MSFD. This tool will be useful mainly for MSFD descriptors D5 (Eutrophication) with CMEMS observation data of chlorophyll *a*. Deltares (www.deltares.nl) has put forward the MSFD-EUTRO tool, a web portal to help policy advisors as well as policy makers to understand, use and appreciate ocean colour data for the MSFD. Blended Chl-*a* products will be available and will take into account CMEMS Chl-*a* observation data. This tool is dedicated to the descriptor D5 (Eutrophication). Cefas (www.cefas.co.uk) will develop *CefMAT* tool to assess the capability and limitation of CMEMS products to answer to the whole MSFD descriptors. All descriptors are concerned, with a focus on D1 (biological diversity) and D2 (non-indigenous species) descriptor(s). Quiet Oceans (www.quiet-oceans.fr) will provide an operational ocean noise forecast service to deliver a spatio-temporal estimation of noise levels due to human activities at sea. This service adapted to the descriptor D11 (Energy including underwater noise) will use temperature, salinity and significant wave height from CMEMS forecasts.

3. Next user uptake calls and links with EuroGOOS

A second series of calls for tender about demonstrations of downstream services is planned to be launched again in September 2017 in order to extend the covered areas of benefits and reach further applications such as fisheries and aquaculture, impact of climate change on the biodiversity, Maritime Space Planning Framework Directive or other EU directives and marine litter.

Moreover, a contract between the Copernicus Marine Service and EuroGOOS has been signed on September 2016 in order to enhance a technical relation between CMEMS and the EU Member State coastal downstream services. At the outcome of this contract, the Copernicus Marine Service and EuroGOOS will be able to work on upstream and downstream issues: this win-win work will both allow CMEMS to improve its service and products for the needs of the Member State services (the Regional Ocean Operational Systems: ROOSes) and allow these downstream services to optimize their use of CMEMS in turn. The contract consists in inventorying, describing, assessing, recommending and defining priorities from and to the Copernicus Marine Service. For instance the Fig. 2 shows a part of the poll form performed by Mercator Ocean and EuroGOOS which aims to get information from ROOSes about their services and their links to the Copernicus Marine Service. Finally, some of ROOSes will be able to answer to the next User Uptake calls for tender, to improve their downstream service regarding the use of CMEMS products, to permit the promotion of their service on the CMEMS website as well as to promote CMEMS on their service in turn.

EuroGOOS
European Global Ocean Observing System

About us Documents News Events Contact

Home Members Regions Working Groups Task Teams EU Initiatives EOOS Global Models Products

EuroGOOS > Downstream Services Inventory

Downstream Services Inventory

The Downstream Marine Services Inventory Form below asks you to provide detailed information about your Model/Downstream Service and the interface (or the lack of interface) with the CMEMS Core Service. It consists of four blocks: general description, level of the Service, use of CMEMS Products (if used), presentation of the Service and targeted users. It may take some time to complete so we recommend that you collate all the necessary information in advance and you do not navigate away from this page while you are completing the form.

Your responses are very much welcome for several reasons:

- To increase the visibility of your Service;
- To improve the quality of your Service by a best use of CMEMS products;
- To improve the CMEMS Core Service following your needs, identified barriers preventing from their use or additional suggestions that may arise from your responses.

If you have any questions relating to this form, please [contact us](#).

Your Name

Email address

Telephone number

Latest News

SDG 14: EuroGOOS commitment towards sustained and integrated ocean observing and open data sharing
June 8, 2017

EuroGOOS General Assembly 2017: Main highlights
June 6, 2017

Sea-level measurements: EuroGOOS note for policymakers released at LMD 2017
May 18, 2017

EuroGOOS Kostas Nitiss Medal and travel grant to young researchers: Call open!
May 5, 2017

Call for abstracts open for 8th EuroGOOS Conference (3-5/10/2017)
April 28, 2017

Engaging industry in use and sharing European marine data: New guide released
April 4, 2017

Fig. 2. The on-line poll form addressed to ROOSes in the CMEMS/EuroGOOS contract framework.

THE NEW CMEMS IBI-WAV FORECASTING SYSTEM: SKILL ASSESSMENT USING IN SITU AND HF RADAR DATA

P. Lorente⁽¹⁾, M.G. Sotillo⁽¹⁾, L. Aouf⁽²⁾, A. Amo-Baladrón⁽¹⁾, E. Barrera⁽³⁾,
A. Dalphinet⁽²⁾, C. Toledano⁽³⁾, R. Rainaud⁽²⁾, M. De Alfonso⁽¹⁾, S. Piedracoba⁽⁴⁾,
A. Basáñez⁽⁵⁾, J. M. García-Valdecasas⁽¹⁾, P. Montero⁽⁶⁾ and E. Álvarez-Fanjul⁽¹⁾

⁽¹⁾ PdE (Puertos del Estado), Madrid, Spain. plorente@puertos.es

⁽²⁾ MF (Meteo-France), Toulouse, France

⁽³⁾ AEMET (Spanish Meteorological Agency), Madrid, Spain

⁽⁴⁾ CETMAR (CEntro Tecnológico del MAR), Galicia, Spain

⁽⁵⁾ USC (University of Santiago de Compostela), Galicia, Spain

⁽⁶⁾ INTECMAR (INstituto TECNológico para el control del medio MARino), Galicia, Spain

Abstract

within the frame of the Copernicus Marine Environment Monitoring Service (CMEMS), the Iberia-Biscay-Ireland Monitoring and Forecasting Centre (IBI-MFC) has recently extended its near real-time forecast capabilities, coincident with the V3 CMEMS Service release. Nowadays, a new operational forecast system is operationally run to generate high resolution wave (WAV) products on the IBI area. The IBI-WAV system is based on a MF-WAM 10-km resolution model application and runs twice a day using ECMWF wind forcing. The main goal of this work is to conduct a thorough skill assessment of IBI-WAV product during a 2-year period (2015-2016). Special emphasis has been placed on the characterization of wave features at the Galician coast (NW Spain). To this aim, in situ and remote-sensed data (from two deep-water buoys and a CODAR HF radar, respectively) have been used as benchmark to validate the outputs from CMEMS IBI-WAV operational wave forecasting system. In this context, an analysis of extreme wave height events during wintertime has been performed due to the significant impact on maritime operations and safety in coastal waters.

Keywords: waves, forecasting, validation, quality, skill, assessment, moorings, HF radar

1. Introduction

Since the CMEMS V3 release (April 2017), the IBI MFC delivers a new wave forecast service for the entire IBI region. The service system is the result of a close collaboration between AEMET, MF, PdE and the computer support of CESGA. The new IBI wave system provides a 5-days regional wave forecast product, updated twice a day (cycles at 00z and 12z).

The wave model used as base of this operational system is the MFWAM. This model is based on the IFS-ECWAM (cycle 38R2) code with changes regarding to the dissipation by wave breaking and the swell damping source terms, as developed in Ardhuin et al. (2010). The MFWAM model was updated in 2014 with the improvements implemented in the FP7 European research project MyWave (Janssen et al., 2014). The model performs a partitioning technique on wave spectra that allows the separation between wind sea and swell wave systems. A classification of primary and secondary swell system is also performed. The MFWAM model is implemented on the IBI domain with a grid size of 10km and with the spectral resolution of 24 direction and 30 frequencies, starting from 0.035 Hz. The IBI-WAV runs are driven by 3-hourly analyzed ECMWF winds and uses boundary conditions (wave spectra) from global CMEMS wave system, which uses the assimilation of altimeters wave data.

Once in operations, the IBI-WAV products are validated through the NARVAL (North Atlantic Regional Validation) web validation tool (Lorente et al., 2016). This tool, originally conceived and used for the skill assessment of physical IBI products, has been upgraded to include a new module devoted to the on-line and delayed-mode validation of IBI-WAV (Fig. 1). In order to evaluate prognostic capabilities in operations, the NARVAL multi-platform skill assessment software routinely compares IBI-WAV against quality-controlled in situ and remote-sensed measurements (provided by moored buoys and a High Frequency radar -HFR-, respectively) and automatically computes statistical metrics and quality indicators on a monthly, quarterly and annual basis.

Here we focus on the multi-parameter accuracy assessment of IBI-WAV products for a two-year period (2015-2016). To this aim, hourly data of significant wave height (Hs), wave period (Tm) and wave direction (Wd) have been thoroughly analyzed on different time basis. The skill of IBI-WAV system has been evaluated by means of the computation of a set of statistical metrics: bias, root mean squared error (RMSE), correlation (CORR), wave roses, the mean percentage error (MPE), qq-plots and best linear fit of scatterplots. Annual results have been summarized with Taylor diagrams.

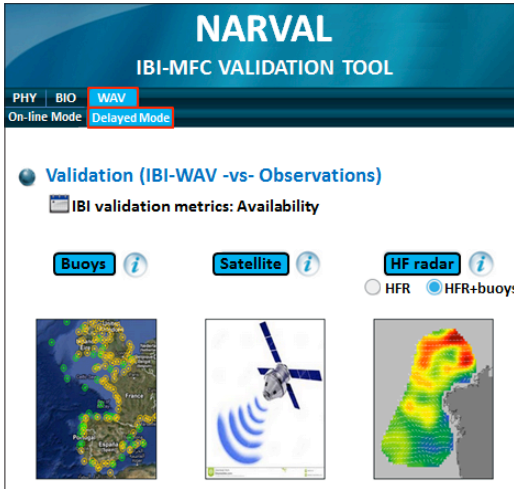

Fig. 1. Snapshot of NARVAL web validation tool. Module devoted to assess the skill of IBI-WAV forecasting product on delayed-mode (red boxes) by conducting regular comparisons against a wealth of independent observations, encompassing in situ (buoys) and remote-sensing (satellite and HF radar-derived) data.

2. Comparison against *in situ* data

NARVAL web-based validation tool automatically performs the validation of IBI-WAV for the grid points adjacent to those buoys moored within IBI spatial domain (Fig. 2-a). The comparisons against quality-controlled time series of in situ data are regularly conducted (on a monthly, seasonal and annual basis) and the statistical metrics routinely computed. An example of annual validation (2016) for a buoy moored in the northern coast of Spain (location of the buoy 2150, marked by the red dot in Fig. 2-a) is provided in Fig. 2 (b-e). According to the scatter plots and the related skill metrics, the accuracy of IBI-WAV is significantly high, with correlation coefficients above 0.9 and moderate RMSE for both Hs and Tm. Likewise, the best linear fit shows the rather linear correspondence between both datasets. The qq-plots reveal that the skill of IBI-WAV slightly decreases for higher values of Hs and Tm.

Annual results are gathered in Taylor diagrams (not shown) for each wave parameter, since they provide a concise statistical summary of how closely hourly IBI-WAV outputs match with in situ wave observations. The Taylor diagrams exhibit that IBI-WAV performance is precise and consistent, (decreasing in coastal areas), with correlation and RMSE values emerging in the ranges [0.82-0.98] and [0.2 m-0.45 m], respectively, for the significant wave height.

3. Comparison against HF Radar

Wave measurements derived from land-based HFR have a broad range of potential applications and can be used as ancillary data source in those regions where in situ time series from moorings are not complete. Previous comparisons against moored buoys have unequivocally proved the positive contribution of commercial HF systems radar to retrieve wave information (Atan *et al.*, 2015).

The CODAR 5 MHz HFR system used in this work, deployed in Galicia (NW Spain) since November 2004 and composed by four sites (from south to north: Silleiro, Finisterre – operated by PdE -, Vilano and Prior – operated by Intecmar), provides 30-minute wave data that are subsequently subsampled at 60 minutes interval to provide consistency in the temporal resolution of the data for validation and analysis. The outermost HFR range arc of Sillerio and Vilano radar sites have been selected to perform the comparison against 2248 and 2246 buoys (respectively) and against IBI-WAV.

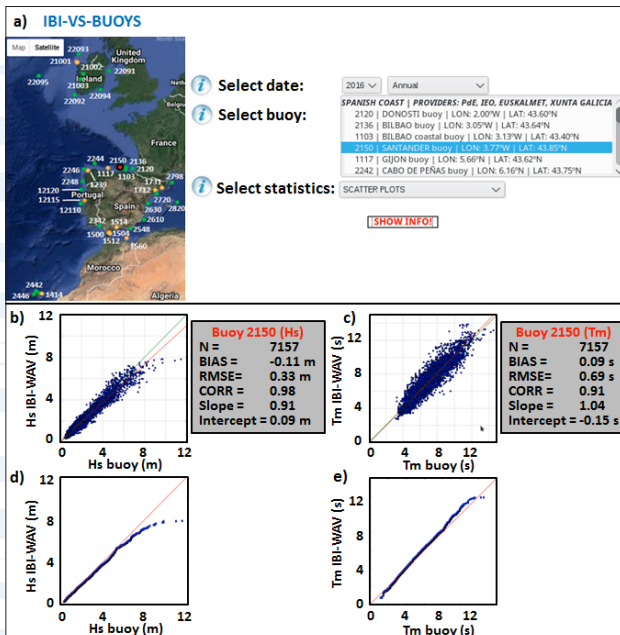

Fig. 2. (a) Snapshot of web section devoted to validate IBI-WAV against available coastal (orange dots) and deep-water (green dots) buoys; (b-e) Annual validation (2016) of significant wave height (left) and wave period (right) in the North of Spain: comparison of IBI-WAV outputs in the grid point closest to buoy 2150 (red dot): scatter (b-c) and qq (d-e) plots. N represents the number of hourly observations.

Fig. 3 illustrates a 3-month (January-March 2015) intercomparison of H_s in the North-West (NW) of Spain. There is a significant resemblance between the three data sources, as reflected by the statistical metrics (correlation coefficients above 0.85). IBI-WAV is able to capture the most extreme wave height events detected by both 2246 buoy and HFR (Vilano site), with several peaks clearly above 7 meters high. Broadly speaking, IBI-WAV (HFR) seems to slightly underestimate (overestimate) the H_s values in this particular example. This multi-platform skill assessment constitutes a useful approach, especially when the reference data sets present sporadic temporal gaps.

The skill of IBI-WAV to predict the wave direction in NW Spain is assessed in Fig. 4 by only using, in this case, HFR-derived (Silleiro site) estimations as benchmark. As it can be seen, the concordance between modeled and remote-sensed W_d data is high. The wave roses are rather similar in terms of both H_s and W_d , with predominant directions coming from NW-W sectors.

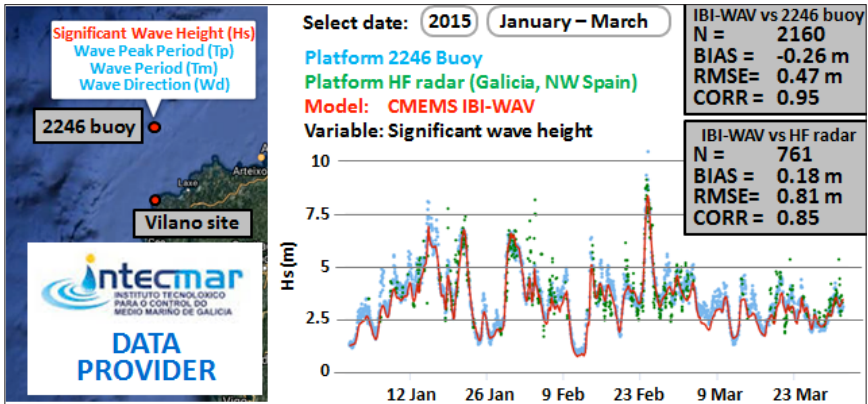

Fig. 3. Intercomparison of significant wave height in NW Spain for a 3-month period (January-March 2015). IBI-WAV forecasting system (red line) is validated against in situ (blue dots) and remote-sensed (green dots) data provided by Vilano-Sisargas buoy (2246) and the Galician HF radar (Vilano site), respectively. Statistical metrics are gathered in grey boxes.

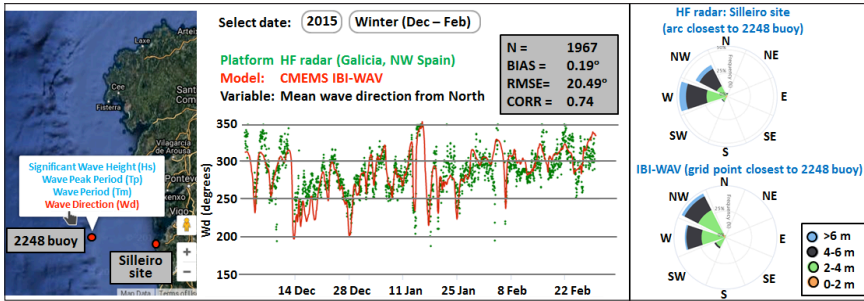

Fig. 4. Validation of wave direction in NW Spain for a 3-month period (December 2014 - February 2015). IBI-WAV forecasting system (red line) is validated against remote-sensed (green dots) data provided by the Galician HF radar (Silleiro site).

4. Extreme wave height events in Galicia (nw Spain)

Extreme wave height events in NW Spain during wintertime (Dec. 2015 – Feb. 2016) have been examined. The MPE between IBI-WAV and 2248 buoy (defined in Fig. 5) has been computed for the significant wave height using 2-m intervals. IBI-WAV is more accurate when Hs is below 6m (MPE below 3%, in absolute value), decreasing the performance for severe sea states (Hs > 6 m). A relevant underestimation for the most extreme events (Hs > 8 m) has been observed. Table I summarizes the skill metrics derived from this multi-platform validation. Overall results show a good agreement between IBI-WAV and 2248 buoy (correlation of 0.95) and between IBI-WAV and HFR (correlation of 0.74), with respective MPE values below 4%. Regarding the seasonally-averaged statistical values, they reveal that the Galician region is sensitive to severe weather episodes (percentile 80 is around 4.8 m), with mean (peak) values of Hs around 3.8m (9 m). The temporal variability is also significant, while Wd is geographically limited to the aforementioned NW-W sections.

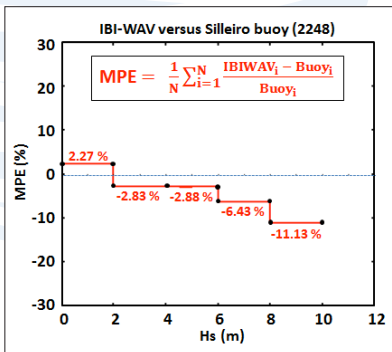

Fig. 5. Mean percentage error (MPE) of Hs with 2-m intervals of wave height, derived from the comparison of IBI-WAV against 2248 buoy hourly measurements for wintertime (Dec 2015-Feb 2016)

Table I. Summary of skill metrics derived from the intercomparison of modelled wave height data against in situ (2248 buoy) and remote sensed-data (HFR-1) for wintertime (Dec. 2015 – Feb. 2016).

WINTER 2015-2016	BUOY 2248	SILLEIRO SITE (HFR-1)	IBI-WAV
Number hourly data	2184	1904	2184
Mean \pm Standard dev.	(3.83 \pm 1.29) m.	(4.27 \pm 1.46) m.	(3.70 \pm 1.25) m.
Max (date)	9.38 m. (2016-02-15)	9.83 m. (2016-02-15)	8.64 m. (2016-02-15)
Percentile 80 -P80-	4.80 m.	5.38 m.	4.71 m.
Number events > P80	401	377	434

METRICS		
IBI-WAV VERSUS...	BUOY 2248	SILLEIRO SITE (HFR-1)
Number hourly data	2184	1904
Bias	-0.13 m.	-0.39 m.
RMSE	0.41 m.	1.05 m.
MPE	-2.85 %	-3.95 %
Correlation	0.95	0.74

5. Future work

There are currently some ongoing actions to improve this NARVAL wave component focusing on: 1) the inclusion of the CMEMS-wave observational products derived from Sentinel-3A mission measurements as part of the pool of satellite data sources used to validate IBI-WAV forecast product; 2) A new functionality to intercompare IBI-WAV product with other CMEMS and non-CMEMS wave models solutions in overlapping regions.

Acknowledgements

The authors gratefully acknowledge: (i) Qualitas Remos Company, for their useful technical suggestions and (ii) INTECMAR, for the HF radar- derived wave data provision (VILANO site).

References

Ardhuin F., R. Magne, J-F. Filipot, A. Van der Westhuyesen, A. Roland, P. Quefeulou, J. M. Lefèvre, L. Aouf, A. Babanin and F. Collard: Semi empirical dissipation source functions for wind-wave models : Part I, definition and calibration and validation at global scales. *Journal of Physical Oceanography*, March 2010.

Atan, R., Goggins, J., Hartnett, M., Nash, S., and Agostinho, P. (2015). Assessment of extreme wave height events in Galway Bay using High Frequency radar (CODAR) data. *Renewable Energies Offshore*, 49–56, DOI: 10.1201/b18973-8.

Janssen, P., L. Aouf, A. Behrens, G. Korres, L. Cavalieri, K. Christensen, O. Breivik: Final report of work-package I of FP7 Research project my wave project. European Commission, December 2014.

Lorente P., S. Piedracoba, M. Sotillo, R. Aznar, A. Amo-Baladrón, A. Pascual, J. Soto-Navarro and E. Álvarez-Fanjul, (2016). Ocean model skill assessment in the NW Mediterranean using multi-sensor data, *Journal of Operational Oceanography* Vol. 9, Issue 2.

SATELLITE DATA BASED AUTOMATED ARCTIC SEA ICE MONITORING SYSTEM

L. Bobylev, V. Volkov, E. Kazakov and D. Demchev

Nansen International Environmental and Remote Sensing Center, Saint Petersburg,
Russian Federation. adm@niersc.spb.ru

Abstract

Sea ice monitoring in arctic region is one the key tasks to supply safe navigation and climate change researches. Approach to organize automated monitoring system, based on radar satellite data (mostly derived from Sentinel-1A/B satellites), are discussed. Proposed system including subsystems of data obtaining, data processing and information delivery. Sea ice classification, sea ice drift retrieval and iceberg detection algorithms are core of discussed system.

Keywords: sea ice, monitoring system, sea ice drift, sea ice classification, iceberg detection, satellite radar data

1. Introduction

Comprehensive monitoring of sea ice in the Arctic area with continuous collection and accumulation of data are necessary not only to ensure safe navigation and operational tasks of navigation, but also for understanding the nature and variability of the large-scale processes in the ocean and atmosphere in the global climate change conditions. Radar satellite data, mainly the data sensing by synthetic aperture radar (SAR) has found wide application in studies of the Arctic region, largely because of insensitivity to cloud cover and possibility for indirect recovery of some physical characteristics of the environment (e.g., wind speed). For now, SAR is one of the main sources of effective data to provide observation of sea ice, especially in operative cases. However, in Russia, until recently, the availability of such data was low: in the Russian group of remote sensing satellites up to now there are no spacecrafts with the SAR equipment, and foreign commercial data (Radarsat, Envisat, TerraSAR-X, TanDEM-X, and others) were not readily available to wide Russian consumers because of the high cost and not always efficient ways of data distribution.

The situation changed in the spring of 2014, when the operational work was started by satellite of the European space Agency - Sentinel-1A, which is equipped with a C-SAR and sensing in a variety of modes in C-band with a spatial resolution up to 5x5 meters. The data supplied with this device is much more available to all interested consumers, and provided with modern and functional distribution system Copernicus Open Access Hub. In the spring of 2016 the second satellite started: Sentinel-1B, which is equipped with identical sensor, and it allowed to significantly increase the frequency of sensing, and, accordingly, the appeal for the solution of monitoring tasks. Arctic waters are covered by the Sentinel-1A/B up to 2 times a day.

Using Sentinel-1A/B data as operative source and, if necessary, adding other information, a sea ice monitoring system in the Arctic was designed to observe sea ice drift with taking into account its types, allowing to control the main processes at different scales in order for safe navigation and accumulation of data on the state of the environment.

2. Monitoring System Components

To build a monitoring system is required to create three main components, combined into; information infrastructure: subsystem of information obtaining and storage; subsystem of data thematic processing; subsystem of information presentation and delivery. The system is built on classical client-server architecture with the implementation of all interactions through a Central interface via standard HTTP Protocol.

2.1 Information obtaining subsystem

Subsystem of data obtained automatically to collect information, communicating with servers of the European space Agency and downloading in real-time emerging data sets on a given territory, and then describing and cataloguing them in a storage subsystem (Fig. 1).

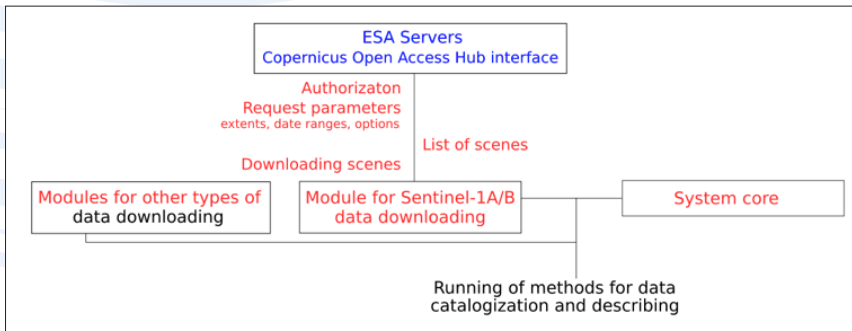

Fig. 1. Simple scheme of Sentinel-1A/B automated downloading in context of monitoring system

2.2 Data processing subsystem

Subsystem of thematic data processing is a key in the described monitoring system, and includes the algorithms: sea ice types classification; sea ice drift retrieval; iceberg detection (for open water).

Automated classification of ice types based on textural characteristics of SAR images and the application of machine learning. In publications (Zakhvatkina *et al.*, 2013, Zakhvatkina *et al.*, 2017) have shown that textural characteristics for different ice types within one area and one season are statistically different and stable in time and space. This allows to prepare the necessary signatures for different seas and to automatically carry out the mapping of ice types. Example of automatic classification is shown in Fig. 2. Abbreviations in the figure are shown: MYI – multiyear ice, FYI thick – thick first-year ice, FYI thin – thin first-year ice, OW – open water, the MIZ – marginal ice zone.

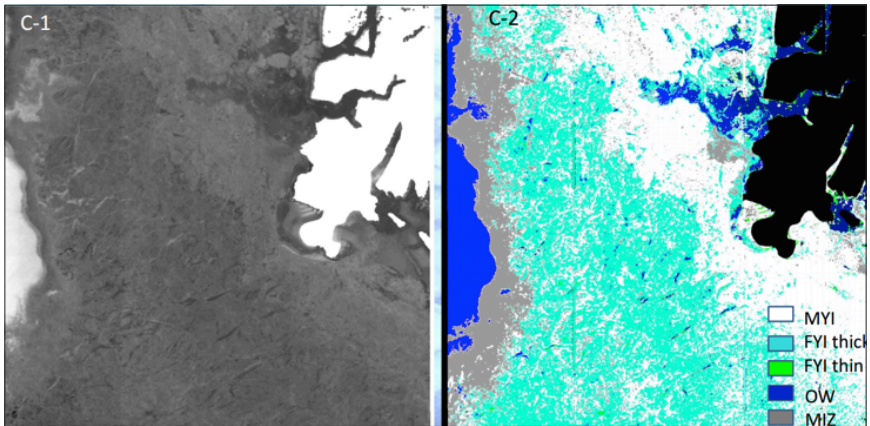

Fig. 2. Left picture - source SAR image, right picture – result of classification.

Retrieving of sea ice drift fields is based on methods of computer vision using nonlinear diffusion in process of creating multidimensional space of images. The main advantage of the proposed method is a very dense and detailed field of the drift, which allows not only to track the direction and speed of ice movement, but also provides much details to calculate the deformation characteristics (Demchev *et al.* 2016; Demchev *et al.*, 2017). Fig. 3 shows results of ice drift retrieving from Sentinel-1A/B imagery.

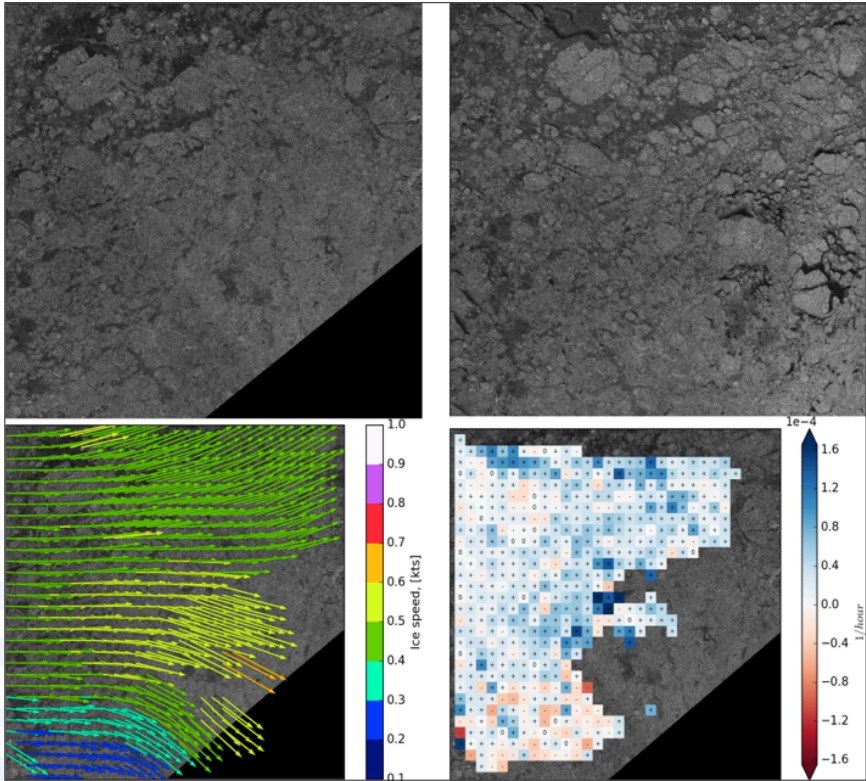

Fig. 3. Top left and right pictures – two source SAR images, sensed with 1 day delay. Bottom left picture – ice drift vectors colored by speed. Bottom right picture – deformation characteristics of sea ice.

Arctic icebergs on radar images are showing like bright spots. An automated method for the rapid detection of icebergs and evaluation of danger, and also for analysis of the patterns of spatial and temporal variability of iceberg distribution, designed to find bright areas in the SAR images. Despite the fact that this approach does not provide unambiguous and reliable identification of icebergs, it allows to assess the statistical regularities of distribution of icebergs in the studied areas. For example, testing calculations for icebergs identification were made for the area of waters in the central part of the Barents sea near the Shtokman field (Fig. 4). Time period from October 2014 to September 2016 was covered, including 4 consecutive seasons. Seasonal variability is characterized by the growth of the number of detected icebergs in the winter hydrological season and the fall during the summer. Analysis of interannual variability revealed that the number of icebergs may vary considerably from year to year, but the trend of seasonal variability remains.

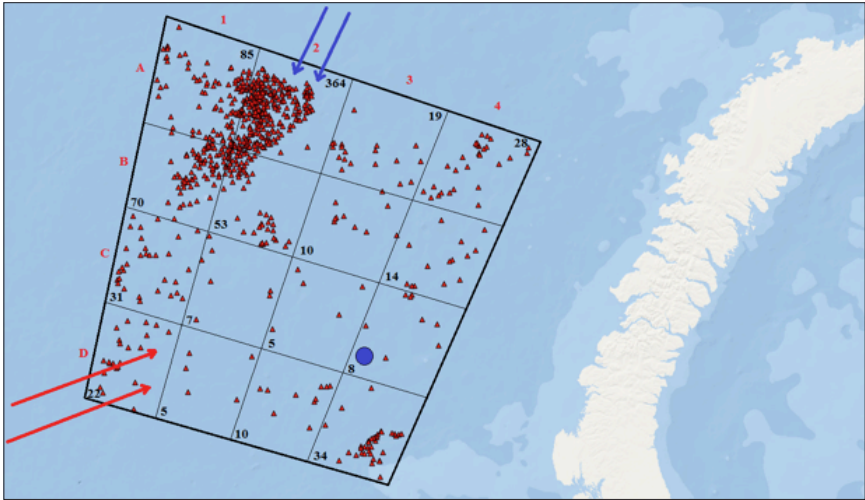

Fig. 4. Distribution of detected iceberg in central part of Barents sea. Red dots are places of detected icebergs for all time of calculations (October 2014 – September 2016), blue circle is Shtokman field, blue and red arrows are water currents.

2.3 Information presentation and delivery subsystem

As the main interface web portal NIERSC Data Center is developing, enabling to search, download, and administrate all data available with web interface. Additional interface is desktop in the form of expansion NIERSC QGIS Toolbox for open QuantumGIS geographic information platform, providing search capabilities and load data directly into the GIS environment (Fig. 5). Desktop tool including software for thematic data processing, which can be run inside GIS interface and operate over GIS datasets.

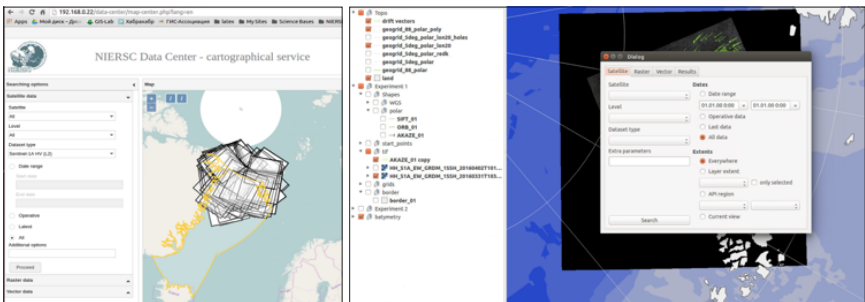

Fig. 5. Left picture – web-based interface for data distribution. Right picture – desktop tool based on opensource QuantumGIS, providing access to monitoring system data and to thematic data processing algorithms.

Using of thematic algorithms to extract information about sea ice is complex, in a unified information system that automates the submission of the original data sets and the thematic treatment, and providing diverse access to the resulting data allows for the supply of operational monitoring and accumulation of data for further scientific analysis.

Acknowledgements

Work is performed under support of RFBR – NRC project (RFBR N°. 15-55-20002) “Development of sea ice monitoring and forecasting system to support safe operations and navigation in Arctic Seas”.

References

- Demchev, D., Volkov, V., Kazakov, E., Alcantarilla, P., Sandven, S., Khmeleva, V. (2017) Sea Ice Drift Tracking From Sequential SAR Images Using Accelerated-KAZE Features. *IEEE Transactions on Geoscience and Remote Sensing*, 55, 5174–5184.
- Zakhvatkina, N., Korosov A., Muckenhuber S., Sandven S., Babiker M. (2017) Operational Algorithm for Ice-Water Classification on Dual-Polarized RADARSAT-2 Images. *Cryosphere* 11, 33-46.
- Demchev, D.M., Volkov, V.A., Khmeleva, V.S., Kazakov, E.E. (2016) Sea ice drift retrieval from SAR using feature tracking. *Problems of the Arctic and Antarctic*, 3, 5-19 (In Russian).
- Zakhvatkina N.Yu., Alexandrov V.Yu., Johannessen O. M., Sandven S., Frolov I.Ye. (2013) Classification of Sea Ice Types in ENVISAT Synthetic Aperture Radar Images. *IEEE Transactions on Geoscience and Remote Sensing* 51, 2587–2600.

STRESS TESTING THE EU MONITORING CAPACITY FOR THE BLUE ECONOMY

N. Pinardi⁽¹⁾, G. Manzella⁽²⁾, S. Simoncelli⁽³⁾, E. Clementi⁽³⁾, E. Moussat⁽⁴⁾, E. Quimbert⁽⁴⁾, F. Blanc⁽⁵⁾, G. Valladeau⁽⁵⁾, G. Galanis⁽⁶⁾, G. Kallos⁽⁶⁾, P. Patlakas⁽⁶⁾, S. Reizopoulou⁽⁷⁾, C. Kyriakidou⁽⁷⁾, I. Katara⁽⁷⁾, D. Kouvarda⁽⁷⁾, N. Skoulikidis⁽⁷⁾, L. Gomez-Pujol⁽⁸⁾, J. Vallespir⁽⁸⁾, D. March⁽⁸⁾, J. Tintoré⁽⁸⁾, G. Fabi⁽⁹⁾, G. Scarcella⁽⁹⁾, A. N. Tassetti⁽⁹⁾, F. Raicich⁽¹⁰⁾, A. Cruzado⁽¹¹⁾, N. Bahamon⁽¹²⁾, F. Falcini⁽¹³⁾, J.-F. Filipot⁽¹⁴⁾, R. Duarte⁽¹⁴⁾, R. Lecci⁽¹⁵⁾, A. Bonaduce⁽¹⁵⁾, V. Lyubartsev⁽¹⁵⁾, C. Cesarini⁽¹⁶⁾, G. Zodiatis⁽¹⁷⁾, S. Stylianou⁽¹⁷⁾, J.-B. Calewart⁽¹⁸⁾ and B. Martín Míguez⁽¹⁸⁾

⁽¹⁾ Department of Physics and Astronomy, Alma Mater Studiorum University of Bologna, Viale Berti Pichat 8, 40127 Bologna, Italy. nadia.pinardi@unibo.it

⁽²⁾ ETT, Via Sestri 37, 16154 Genoa, Italy

⁽³⁾ Istituto Nazionale di Geofisica e Vulcanologia, Via Franceschini 31, Bologna, Italy

⁽⁴⁾ Ifremer, Centre Bretagne - ZI de la Pointe du Diable - CS 10070 - 29280 Plouzané, France

⁽⁵⁾ CLS, 8-10 rue Hermes, Parc Technologique du Canal, 31520 Ramonville St Agne, France

⁽⁶⁾ University of Athens, Department of Physics, Atmospheric Modeling and Weather Forecasting Group, University Campus Bldg Phys-5, 15784 Athens, Greece

⁽⁷⁾ Hellenic Centre for Marine Research, Institute of Oceanography, P.O. Box 712, 19013 Anavyssos, Greece

⁽⁸⁾ SOCIB, ParcBit, Edif. Naorte, Bloc A, planta 2, pta. 3, 07121 Palma (Mallorca) Spain

⁽⁹⁾ CNR-ISMAR, Largo della Fiera della Pesca, 1 60125 Ancona, Italy

⁽¹⁰⁾ CNR-ISMAR, AREA Science Park, Q2 bldg., SS 14km 163.5, Basovizza, I-34149 Trieste, Italy

⁽¹¹⁾ Oceans Catalonia International SL, Veinat del Pibitller bústia 2019, E-17412 Maçanet de la Selva, 17300, Blanes, Spain

⁽¹²⁾ CEAB_CSIC, C/ d'accés a la Cala St. Francesc, 14, Blanes - Girona – 17300, Spain

⁽¹³⁾ ISAC-CNR, Via Fosso del Cavaliere, 100 - 00133 Roma, Italy

⁽¹⁴⁾ France Energies Marines, 15 rue Johannes Kepler 29200 Brest, France

⁽¹⁵⁾ Centro Euro-Mediterraneo sui Cambiamenti Climatici, Italy

⁽¹⁶⁾ CLU Srl, Via Togliatti 17/c, 41013 Castelfranco Emilia, Italy

⁽¹⁷⁾ University of Cyprus-Oceanography Centre, 75 Kallipoleos Avenue 1678, Nicosia, Cyprus

⁽¹⁸⁾ Seascope Consultants Ltd, Romsey, United Kingdom

Abstract

An EMODnet activity has started in 2013 to assess how well the European marine monitoring data meets the requirements of a sustainable blue economy. The activity is done by six European Sea Basin Checkpoints listed in the EMODnet central web page: <http://www.emodnet.eu/checkpoints>.

Checkpoints should develop an assessment framework that considers “Use Cases” or “Challenges” to evaluate the fitness for use of input monitoring data sets. The Challenge products are related to both Blue Growth¹ and the Marine Strategy Framework Directive² objectives. The idea is that the quality of the Challenge products will inform stakeholders on how monitoring data set are “fit for use”.

The Checkpoint assessment framework developed for the Mediterranean Sea is implemented through a “Service” composed of: 1) a GIS metadatabase with information about upstream data sources for Challenge products and availability indicators; 2) a Web GIS product display, encompassing links to the upstream data sources; 3) a tool to evaluate and display the statistics of assessment indicators. User requirements are recorded in the product catalogue (Data Product Specifications), which can be viewed for corrective actions.

The same assessment framework is now being applied to the Atlantic and the Black Sea thus producing in the near future the first large basin scale assessment of input monitoring data set adequacy for applications.

Keywords: EMODnet, Checkpoint assessment, Challenge products, Mediterranean Sea

¹ European Commission – Maritime Affairs – Blue Growth – Opportunities for marine and maritime sustainable growth, 2012 http://ec.europa.eu/maritimeaffairs/documentation/publications/documents/bluegrowth_en.pdf

² European Commission – Environment – Our Oceans, Seas and Coasts – Legislation: the Marine Directive, 2012 http://ec.europa.eu/environment/marine/eu-coast-and-marine-policy/marine-strategy-framework-directive/index_en.htm

1. Introduction

The objective of the EMODnet Checkpoint initiative is to assess how monitoring meets the needs of public and private users by generating Challenge products that are related to societal needs. The main stakeholder of the Checkpoint initiative is the European Marine Observation and Data Network (EMODnet), that is, a network of marine organisations supported by the EU’s Integrated Maritime Policy.

The required Challenge outputs for the Mediterranean Sea have been defined by EMODnet and they are listed in Table 1.

Table 1. CheckPoint Mediterranean Sea Challenges required outputs.

CHALLENGE	INFORMATION PRODUCT TO BE DELIVERED (REQUESTED BY STAKEHOLDER)
CH1-Windfarm siting	Suitability of sites for wind farm development
CH2-Marine Protected Areas	Representativeness and coherency of existing European network of marine protected areas (national and international sites) as described in article 13 in the Marine Strategy Framework Directive.
CH3-Oil Platform leak	Likely trajectory of a leak from an oil platform and the statistical likelihood that sensitive coastal habitats or species or tourist beaches will be affected within 24 hours and after 72 hours.
CH4-Climate and Coastal Protection	Spatial data layers for the following parameters for the past 10 years, the past 50 years and the past 100 years <ul style="list-style-type: none"> • average annual change in temperature at surface, midwater and sea-bottom • average annual sea-level rise at the coast (absolute and relative to the land) • sediment mass balance at the coast Time plots for the following parameters for the whole sea basin <ul style="list-style-type: none"> • average annual sea temperature over sea-basin at surface, mid-water column and bottom. • average annual changes in internal energy of sea
CH5-Fisheries Management	<ul style="list-style-type: none"> • tables for the whole sea-basin of mass and number of landings of fish by species and year • mass and number of discards and bycatch (of fish, mammals, reptiles and seabirds) by species and year • data layers (gridded) showing the extent of fisheries impact on the sea floor • area where bottom habitat has been disturbed by bottom trawling (number of disturbances per month) • change in level of disturbance over past ten years
CH6-Marine Environment	Data layers (gridded) showing <ul style="list-style-type: none"> • seasonal averages of eutrophication in the basin for past ten years • change in eutrophication over past ten years (i.e. where eutrophication has reduced and where it has increased)
CH7-Rivers	For each river bordering the sea basin, the country where it enter the sea and a time series of annual inputs from rivers of <ul style="list-style-type: none"> • water • sediment • total nitrogen • phosphates • eels Monthly averages, maxima and minima for these parameters over the past ten years

An assessment of the marine environmental monitoring capacity, based upon final products generated with observations and model data, has never been attempted before in the world, so the Mediterranean Sea Checkpoint developed an entirely new methodology at the same time implementing it for the required outputs of Table 1.

In Section 2 we will describe the Checkpoint methodology and in Section 3 we will overview the final Checkpoint assessment and the gap analysis.

2. The checkpoint methodology and service

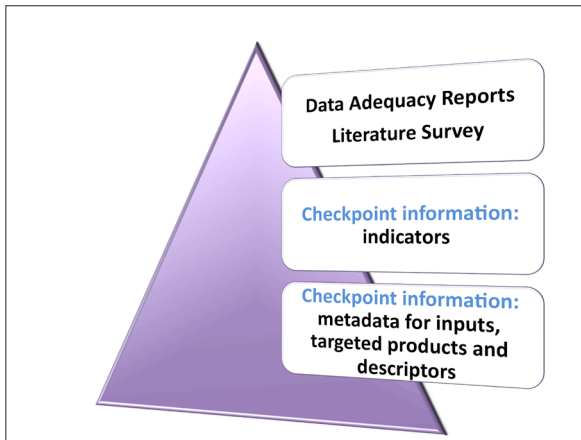

Fig. 1. The Checkpoint methodology.

The Checkpoint assessment framework is based upon three major pillars:

1. Use of the ISO principles for the methodological development and the metadata definition of input data sets (the monitoring data sets as required in the Data Product Specification);
2. Design of the metadatabase containing the information about the input (upstream) data sets, the Targeted products and the quality indicators;
3. Definition of indicators for the objective assessment of the data adequacy following INSPIRE rules.

The ISO principles used to describe the input data sets can be found in the open access EMODnet MedSea Checkpoint browser, available here: <http://www.emodnet-mediterranean.eu/browser/>. All input data sets for the Challenges are described and catalogued following the SeaDataNet vocabulary for "Characteristics", i.e. an attribute of a distinguishing feature that refers: either to a variable derived from the observations, the measurement or the numerical model output of a phenomenon or of an object in the environment, or to the geographical representation of an object on a map by a set of vectors (polygon, curve, point) eg "coastline".

Each input data set is then classified in terms of which characteristics it refers to, the spatial and temporal structure of the data set, the environmental matrix it belongs to, the data producer and the original use of the data set. The assessment framework followed two main paths:

1. An expert opinion on the quality of the Challenge Targeted products and their related input data set adequacy;
2. A set of "indicators" that classify the "fitness for use" of the input data sets and the "fitness for purpose" of the targeted products.

For the indicator path, two assessment were chosen: the first, so-called "Availability territory" answers the question of "how the input data sets are made available to Challenges, while the second, so-called "Appropriateness territory" answers the question "What is the quality of the monitoring data for the Challenge products". Eight indicators have been chosen for each territory, listed in Table 2.

Indicators provide both an overview of the situation as well as information about trends, if continuously updated, at a high level of aggregation. The difficult task is to find an appropriate balance between simplification and completeness and offer, at the same time, an assessment of the input data sets without directly accessing all the metadata.

Table II. Availability and Appropriateness indicators nomenclature.

AVAILABILITY TERRITORY	APPROPRIATENESS TERRITORY
Definitions	Definitions
Visibility Indicators	Completeness (ISO) Indicators
Easily found	Horizontal Spatial Coverage
EU Inspire Catalogue service	Vertical Spatial Coverage
Accessibility Indicators	Temporal Coverage
Policy visibility	Accuracy (ISO) Indicators
Delivery	Horizontal Resolution
Data Policy	Vertical Resolution
Pricing	Temporal Resolution
Readiness	Thematic Accuracy
Performance Indicator	Temporal Quality (ISO) Indicator
Responsiveness	Temporal Validity

For the Availability indicators the Checkpoint has defined 4-6 possible values of each indicators to be chosen by the project experts, according to the information on the input data they succeeded to collect and according to the conditions of access they experienced. The appropriateness indicators (Fig.2) are “errors” defined as the difference between the required monitoring input data set (DPS) and the actual Upstream Data used (UD).

For each indicators we defined a “color scale” with the following meaning:

- Red:** urgent actions are required to provide datasets and services fitting for use – totally inadequate
- Yellow:** limited actions are required to provide datasets and services fitting for use – partly adequate
- Green:** actions and services are fit for use and should be maintained – fully adequate

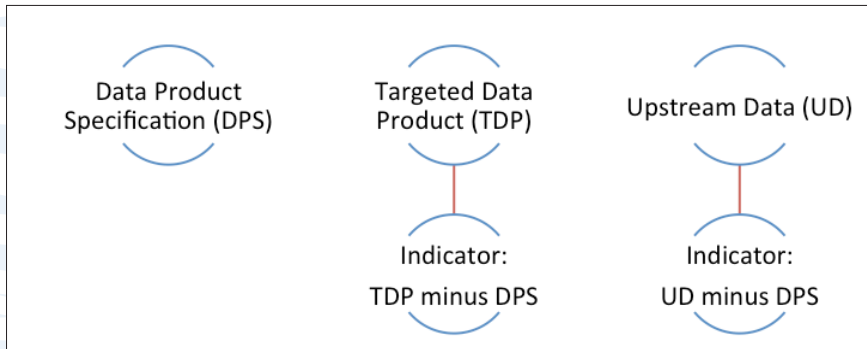

Fig. 2. High level scheme for the appropriateness indicators: Quality Elements are decided for DPS and reproduced for TDP and UD so that a “difference” (TDP minus DPS or UD minus DPS) can be calculated and this gives indicator values.

Following INSPIRE rules, all the input data sets, the upstream data sets and the Targeted products have been displayed in a Web Portal available to everybody for discovery: <http://www.emodnet-mediterranean.eu/>. In this Portal a Checkpoint Service has been defined and implemented: <http://www.emodnet-mediterranean.eu/checkpoint-service/>. Each Challenge has a proper page (<http://www.emodnet-mediterranean.eu/challenges/>) where the input data sets and the Products that make use of them, are listed and displayed. Links give access to the product specifications (DPS) and the full description of the assessment results both for the targeted product and for the input data sets, allowing end-users and data providers to directly access the results.

3. The monitoring assessment and the Gap Analysis

The Checkpoint metadatabase contains 266 input dataset descriptors, which identify and assess potentially usable information for the construction of the Targeted Products. 45 Targeted Products have been generated following the stakeholder requests. Only 90 over the 266 input dataset, spanning 29 different characteristics, have been used for the realization of the 45 Targeted Products.

This means that only approximately 3 data sets per characteristics can be used to determine the “fitness for use” of the monitoring system for each characteristic. Statistical validity of the results is somewhat low and thus the project decided to find the key gaps or the most important monitoring inadequacy by selecting the characteristics that scored lowest indicator values (red) for both availability and appropriateness. If statistics will be larger in the future we could most likely use a better combination of the indicators.

The final assessment results for the Mediterranean Sea (Pinardi *et al.*, 2017) and for all the Challenges point out that:

1. Sediment mass balance data are not available at the basin scale and products cannot be constructed at the basin scale level;
2. Fishery data sets are inadequate for the following key quality attributes: visibility, INSPIRE catalogue, data policy visibility, readiness, data delivery and data policy, horizontal and temporal coverage, temporal validity;
3. The biological habitat extent characterization (*Posidonia oceanica*, Coralligenous and Maerl habitats, seabed sensitive habitats) input data sets are also inadequate in terms of Data Policy and Responsiveness, Vertical and horizontal coverage, temporal and horizontal resolution.
4. The wave height, period and direction input data sets are inadequate in terms of visibility, INSPIRE Catalogue, Data Policy, Pricing, responsiveness, temporal coverage, horizontal and temporal resolution.
5. The Platform movement characteristics, i.e. maritime traffic data sets, are inadequate in terms of visibility, INSPIRE Catalogue, responsiveness, horizontal and temporal coverage, temporal validity.

The methodology developed for this assessment is now being applied to the Atlantic and the Black Sea basins thus producing in the near future the first large basin scale assessment of input monitoring data set adequacy for societal applications.

Acknowledgements

This work was supported by the EMODnet Mediterranean Sea Checkpoint Project, Service Contract N° SI2.658137 - MARE/2012/11 – lot 2 The Mediterranean “Growth and innovation in Ocean Economy: Gaps and priorities in sea basin observation and data”. We thank the EMODnet North Sea Checkpoint project for the fruitful exchange of ideas and all the other Checkpoints for interesting discussions.

References

Pinardi, N., Simoncelli, S., Clementi, E., Manzella, G., Moussat, E., Quimbert, E., ... Stylianou, S. (2017). EMODnet MedSea CheckPoint Second Data Adequacy Report (Version 1). European Marine Observation and Data Network. https://doi.org/10.25423/cmcc/medsea_checkpoint_dar2.



EMODNET PHYSICS: TACKLING NEW CHALLENGES

A. Novellino⁽¹⁾, P. Gorringe⁽²⁾, D. Schaap⁽³⁾, P. Thijsse⁽³⁾, S. Pouliquen⁽⁴⁾, L. Rickards⁽⁵⁾
and G. Manzella⁽¹⁾

⁽¹⁾ ETT SPA, via Sestri 37, 16154 Genova, Italy. antonio.novellino@ettsolutions.com

⁽²⁾ EuroGOOS AISBL, Avenue Louise 231, 1050 Brussels, Belgium

⁽³⁾ MARIS BV, Koningin Julianalaan 345 A, 2273 JJ Voorburg, The Netherlands

⁽⁴⁾ IFREMER, 625 Route de Sainte-Anne, 29280 Plouzané, France

⁽⁵⁾ BODC NOC NERC, Joseph Proudman Building, University of Liverpool, Liverpool, UK

Abstract

EMODnet Physics, one of the thematic portals, is developing a combined array of services and functionalities (facility for viewing and downloading, dashboard reporting and M2M communication services) to obtain, free of charge data, meta-data and data products on the physical conditions of the oceans from many different distributed data bases.

The work of the EMODnet Physics partners (www.emodnet-physics.eu) is built on the EuroGOOS network of observing platforms and the SeaDataNet protocol for accessing archived data from national oceanographic data centres. The collection of physical parameters is largely an automated process which allows the dissemination of near real time information. The infrastructure for storing and distributing these data is shared with the Copernicus Marine Environment Monitoring Service, CMEMS. A memorandum of understanding with CMEMS, defining the roles of both parties, was signed in August 2016.

The portal provides access to data and products of: wave height and period; temperature and salinity of the water column; wind speed and direction; horizontal velocity of the water column; light attenuation; sea ice coverage and sea level trends. EMODnet Physics is continuously enhancing the number and type of platforms in the system by unlocking and providing high quality data from a growing network.

In this paper, we provide, an overview of EMODnet Physics progresses up to date and planned activities such as to include river and underwater noise data, and new platforms and parameter oriented plot products.

Keywords: Oceanography, Physics, Near Real Time, historical dataset, interoperability

1. Introduction

Access to marine data is of vital importance for marine research and a key issue for various studies, from climate change prediction to off shore engineering. Giving access to and harmonising marine data from different sources will help industry, public authorities and researchers find the data and make more effective use of them to develop new products, services and improve our understanding of how the seas behave.

The European Commission, represented by the Directorate-General for Maritime Affairs and Fisheries (DG MARE), is working on services for assembling marine data, metadata and data products and facilitating their access and re-use. European Marine Observation and Data Network (EMODnet) is a long-term programme to deliver a marine observation infrastructure offering the most effective support to the marine and maritime economy whilst supporting environmental protection needs. The EMODnet data infrastructure is developed through a stepwise approach in three major phases. Currently EMODnet is the 3rd and final phase of development with 8 thematic portals in operation providing access to marine data from the following themes: bathymetry, geology, physics, chemistry, biology, seabed habitats, human activities and coastal mapping.

In the following sections, we provide an overview of EMODnet Physics progress and planned activities such as to include river and underwater noise data and new platforms and parameters oriented plot products.

2. EMODnet PHYSICS

EMODnet Physics, one of the eight thematic portals, has developed a combined array of services and functionalities (facility for viewing and downloading, dashboard reporting and M2M communication services) to obtain, free of charge data, meta-data and data products on the physical conditions of oceans from many different distributed data bases.

The work of the EMODnet Physics partners (www.emodnet-physics.eu) is built on the EuroGOOS network of observing platforms and the SeaDataNet protocol for accessing archived data from national oceanographic data centres. The collection of physical parameters is largely an automated process which allows the dissemination of near real time information. The infrastructure for storing and distributing these data is shared with the Copernicus Marine Environment Monitoring Service, CMEMS. A memorandum of understanding with Copernicus, defining the roles of both parties, was signed in August 2016. By means of joint activities with its three pillars, SeaDataNet, CMEMS, EuroGOOS and with relevant organizations and associations within the sector, EMODnet is undergoing significant improvements and expansion.

The portal is providing a single point of access to recent and past data and products of: wave height and period; temperature and salinity of the water column; wind speed and direction; horizontal velocity of the water column; light attenuation; sea ice coverage and sea level trends; and it is adding new parameters such as river data and underwater noise.

2.1 Data flow

The EMODnet Physics data system is updated three times a day. Generally, near real time (NRT) datasets are managed by the EuroGOOS ROOSs and the CMEMS INSTAC¹. For each EuroGOOS Region there is a Regional Data Assembly Centre (RDAC) closely cooperating with the INSTAC and connecting organisations operating monitoring platforms. The INSTAC architecture is decentralised. However, quality of the products delivered to users must be equivalent wherever the data are processed. The monitoring operators are called 'production units (PUs)'. A PU is responsible for its observing system, which collects controls and distributes data according to its own rules. An RDAC is responsible for assembling data provided by PUs and provides a unique data access point to bundle available data into an integrated dataset for validation and distribution (whereby validation is following common EuroGOOS DATAMEQ - EMODnet harmonized procedures). Each RDAC validates the dataset consistency in their area of responsibility, typology of data and typology of parameter. Routinely (e.g: every hour), each RDAC distributes all its new data on a regional FTP portal. The data file format is an implementation of NetCDF OceanSITES format.

NRT data for past 60 days are made available in daily datasets; older data are made available in both "monthly" datasets (every month the latest 30 days data are reorganized into the "monthly" dataset file). Each platform can provide one or more parameters. Operational platforms provide data time series as soon as data is ready – e.g. a fixed platform delivers data daily (at least), an ARGO float delivers almost weekly. Periodically (depending on the type of platform and data network) the monthly dataset files are updated with delayed mode data (the system is always linking the last updated datasets). Reprocessed data consist of a single-dataset file for each platform covering the last 20-30 years of measurements and it is made available after qualifying and reprocessing data (these products are the result of the joint collaboration and activities of the EuroGOOS-ROOSs, CMEMS INSTAC and SeaDataNet NODCs).

European historical validated data is organised in coordination and cooperation with SeaDataNet and the network of National Oceanographic Data Centres (NODCs). During operations, quality control is performed automatically on the data that is made available in real-time and near real-time. A further validation and quality control takes place when the data are passed to data centres for long-term storage and stewardship. At the end of the process, a CDI (Common Data Index) is published and provides the user with the metadata of the processed dataset.

¹ NRT data flow from HF Radar, under water noise sensors, river stations is managed by EMODnet Physics directly, NRT data flow from not European platforms are managed by local infrastructures (e.g. IMOS, IOOS, etc). [publications/documents/bluegrowth_en.pdf](https://publications.jrc.ec.europa.eu/publications/documents/bluegrowth_en.pdf)

2.2 EMODnet Physics dynamic map

The machinery described in the previous paragraph feeds the EMODnet Physics portal and its dynamic map, i.e. www.emodnet-physics.eu/map This is the central tool for users to search, visualize and download data, metadata and products. For near real time (NRT) data, the map allows viewing/retrieving measurement points, values of data and quality of data within a specified time, i.e. last 7 days, last 60 days, and older data (the system is pre-set to show platforms that provided at least one dataset for the past 7 days). The geographical area (space window) defines the area of interest within which the measurement points, values of data and quality of data are presented. Information about the data originator, curator etc. is also provided. The tool serves to visualize and retrieve data products such as time plots for specific parameters (e.g. monthly averaged temperature for data acquired during the specified time window). The map also provides the user with links to the EMODnet Physics products.

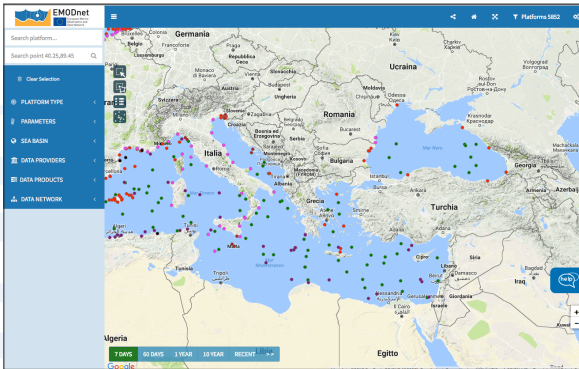

Fig. 1. The EMODnet Physics map page.

2.3 Platform metadata and data plots

For each connected platform, a dedicated platform page is available. These pages provide the user with metadata, plots, download features, platform products e.g. monthly averages or wind plots, more info and links, as well as statistics on the use of the data from that platform. Data quality information is available in connection to the data. According to the typology of the platform both the platform page sub-sections and layout may change: e.g. in case of a HF Radar the page is presenting the bidimensional data for the sea surface current direction and intensity, as well as a current rose once the user specifies (clicks on) a position. If the user selects an ARGO, the page shows the profiles as recorded during the cycles; a tide gauge shows sea level as well as sea level means and trends. Quick download and widgets to include the plots in third-part portals are also available and described.

2.4 Products and products page

While the map is providing the measuring capacity and the platform pages, the products page shows a specified parameter as recorded by all the same platform type. These products are available for ARGO, drifting buoys, Ferryboxes and ships, HF Radars. They are based on operational data and are managed by a sliding window of 60 days. In general, the user can select two time windows: 7 days and 60 days.

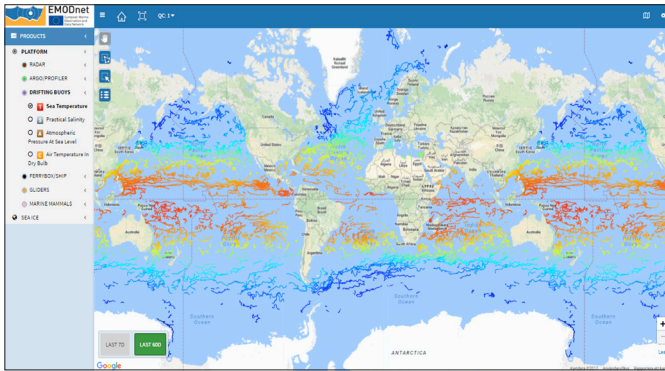

Fig. 2. “Spaghetti plot”, i.e. sea surface temperature as recorded by drifting buoys for past 60 days - <http://www.emodnet-physics.eu/map/Products/V2/PRODUCTS.aspx?PRODTYPE=RT&type=DB¶m=TEMP>.

Based on the CMEMS - SEAICE_GLO_SEAICE_L4_NRT_OBSERVATIONS_011_001 product, EMODnet Physics is generating Sea Ice products. These are both for operational (daily information on the ice is also made available on the WMS/WFS service) and (re) analysis use (e.g. long term time-series and trends). The Permanent Service for Mean Sea Level Monitoring, PSMSL, sea level trends and the Marine Mammals Exploring the Oceans Pole to Pole, MEOP, database containing data on water column temperature and salinity as recorded by marine mammals, in particular from seals, is also integrated and available in the EMODnet Physics portal.

EMODnet Physics is working including data from underwater noise and river flow. The activity will focus on the definition of the data model, data infrastructure, naming conventions and demonstration of how this data can be collected in near real time, organized, and processed (reprocessed data integrated by model output and satellite data when needed) into innovative and useful products.

2.5 Data policy

Data is open and free² and, in agreement with its pillars, EMODnet Physics is applying the following general policy.

Download without authentication:

- Latest 60 days of operational data;
- Operational data from platforms contributing to international programs (e.g. ARGO);
- Data already available free and open/explicit request form the provider (e.g. SOCIB data);

Download with authentication (CMEMS Service Level Agreement):

- Data older than 60 days (European Coastal platforms);
- Reprocessed/delay mode data;

Download with authentication (SDN Service Level Agreement) :

- CDI - historical data hosted by NODCs.

2.6 Machine to Machine services

EMODnet Physics is developing interoperability services to facilitate machine-to-machine interaction and to provide further systems and services with European seas and ocean physical data and metadata. Interoperability services are provided by a GeoServer infrastructure that is OCG compliant. The WMS and WFS layers offer information about which parameters are available (where and who is the data originator, etc.). EMODnet Physics also provides SOAP - web services which allow linkage to external services with near real time data stream and facilitate a machine-to-machine data fetching and assimilation. Lately, EMODnet Physics developed plot widgets³ to embed a parameters plot/chart into an external portal.

² Some data may require negotiation/specific agreements.

³ Widget syntax: www.emodnet-physics.eu/Map/Charts/PlotDataTimeSeries.aspx?paramcode=PPPP&platid=ZZZZ&timerange=YY; where PPPP is the parameter (e.g. TEMP = sea temperature), ZZZZ is the platform ID (e.g. 8427 is Arkona) and YY is either 7 or 60 (days)

3. Conclusions

EMODnet Physics partnership has dedicated important efforts to build gateways to national, regional and thematic data repositories. A comprehensive network has been developed and the actual project directly involves about one hundred institutions from all over Europe. EMODnet Physics is supporting actions on the adoption of common Quality Assessment - Quality Control protocols, by participating at dedicated meetings and projects. The marine data from diverse sources are made more visible, accessible and interoperable.

Data and data products are accompanied by metadata covering information on ownership, data quality and data quality check procedures, as well as links to get more information on methods used for their constructions. Furthermore, EMODnet Physics has created relationships to provide data access to- and preview for- coastal data in non-European areas (e.g. NOAA platforms for the US, IAPB platforms for the Arctic area, IMOS for Australia and others).

The portal is now covering all European Seas as well as the global ocean and it incorporates data from supplementary physical monitoring systems: Argo (all the Argo data are available), gliders, and emerging measurement systems (i.e. HF radar). It provides access to about 20,000 platforms and all available data and metadata have the same standards and formats (e.g. NetCDF, csv).

On top of these data, the EMODnet Physics portal provides a combined array of services and functions to users, for viewing and downloading data (both manually and machine-to-machine), meta-data and data products on the physical conditions of European sea basins and oceans.

Acknowledgements

EASME/EMFF/2016/006 - Operation, development and maintenance of a European Marine Observation and Data Network - EASME/EMFF/2016/1.3.1.2 – Lot 3/ SI2.749411.

THE IN SITU COMPONENT OF THE CMEMS – COPERNICUS MARINE ENVIRONMENT MONITORING SERVICE –

L. Petit de la Villéon⁽¹⁾, S. Pouliquen⁽²⁾ and CMEMS INSTAC partners⁽³⁾

⁽¹⁾ IFREMER Plouzané, France. Loic.Petit.de.la.Villéon@ifremer.fr

⁽²⁾ IFREMER Plouzané, France. Sylvie.pouliquen@ifremer.fr

⁽³⁾ CMEMS INSTAC partners. Instac_members@listes.ifremer.fr

Abstract

The Copernicus Marine Environment Monitoring Service (CMEMS) measures, models and forecasts the state of the global oceans and European regional seas, providing more than 150 specific products comprising data from satellite images, ocean forecast models and ocean observations (measurements taken in the sea). The role of the CMEMS Thematic Assembly Centres (TACs) is to collect, process and quality control upstream satellite and in situ data required both to constrain and validate modelling and data assimilation systems and to directly serve downstream applications and services. Within CMEMS, the In Situ Thematic Assembly Centre (INSTAC) ensures that a steady supply of these in situ ocean measurements is made available to the other service components.

Keywords: In situ, Copernicus, Operational Oceanography

1. Introduction

1.1 In Situ component within CMEMS

The Copernicus Marine Service is based on a distributed model of service production, relying on the expertise of a wide network of participating European organisations involved in operational oceanography. The Service encompasses two kinds of production centres: 1. Monitoring and Forecasting Centres (MFCs), charged with maintaining numerical models of the ocean 2. Thematic Assembly Centres (TAC), which are tasked with the collection of ocean observations, both in situ (water column) and satellite observations. There are seven MFCs: six for regional seas and one for the global ocean. The six regional MFCs cover the areas defined as Regional Ocean Observing Systems (ROOS) areas under EuroGOOS, namely the Arctic Ocean, the Baltic Sea, the European North-West Shelf Seas, the Iberia-Biscay-Ireland Regional Seas, the Mediterranean Sea

and the Black Sea. To each MFC (regional and global) corresponds an in situ data production unit, and INSTAC itself acts as a centralised clearing house for the collection and integration of water column and surface data from this distributed network of in situ data centres.

1.2 Objectives of the In Situ component of CMEMS

The In Situ Thematic Assembly Centre, or INSTAC, is one of the components of the Copernicus Marine Service. Its role is to ensure that the Service has consistent and reliable access to a range of in situ data for the purpose of service production and validation. It aims at providing a global picture of the ocean state and variability by integrating thousands of local data from on-site sensors on board of a wide range of platforms operated by a few hundred of institutes. The In situ TAC deals with the collection of data from a wide range of networks and the development of homogenized quality control and validation procedures as well as high-level data products.

INSTAC has two main objectives:

1. To collect multi-source, multi-platform, heterogenous data, perform consistent quality control and distribute it in a common format (NetCDF) and in near-real-time (within 24 hours) to the CMEMS Marine Forecasting Centres (MFC), for assimilation into their numerical ocean models. Models need a constant supply of observation data in order to keep producing valuable forecasts, and assimilation is the process whereby new data is incorporated into the models.
2. To supply the MFCs and downstream users with re-processed 25-50-year products in delayed mode. In addition to the near-real-time products, these delayed-mode products are useful for model validation or assimilation in ocean reanalysis and climate studies.

2. INSTAC Operations

2.1 INSTAC organisation

16 institutes have joined their expertise to provide an in situ service compliant with CMEMS requirements. The INSTAC is coordinated by Ifremer in France. Each regional in situ data production centre has its own coordinator: 1. HCMR (Greece) for the Mediterranean Sea 2. IOBAS (Bulgaria) for the Black Sea 3. IMR (Norway) for the Arctic 4. SMHI (Sweden) for the Baltic Sea 5. BSH (Germany) for the North West Shelves region 6. Puerto del Estado (Spain) for the Iberia-Biscay-Ireland zone and Coriolis (France) for the global ocean. These leaders interact closely with national and international observing systems operators and data providers in close link with EuroGOOS and JCOMM (Joint Technical Commission for Oceanography and Marine Meteorology under WMO and IOC).

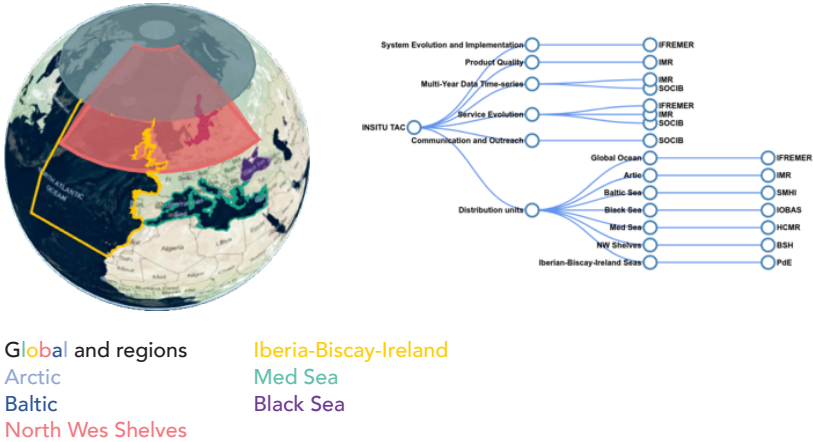

Fig. 1. The region breakdown within INSTAC and partners respective roles.

2.2 INSTAC operations

Within the broader community of operational oceanography, a wide range of national and international networks collect data of different kinds is necessary to fit the needs of a variety of users. The international Argo program is an emblematic example of such initiatives. CMEMS INSTAC collects data from many of these disparate data sources, carries out coherent quality control, and distributes data products in a consistent and homogenous manner. Homogeneity and standardisation are essential to ensure a coherent and efficient copernicus marine service. consistency with what is done at international level is also important. The focus of the CMEMS INS TAC is on parameters that are presently necessary for CMEMS MFCs namely temperature, salinity, sea level, currents, waves, chlorophyll-a/fl uorescence, oxygen as well as nutrients (full list of parameters is available on <http://dx.doi.org/10.13155/40846>). Distributing a global and exhaustive ocean dataset means that INSTAC has to rely on the expertise of its regional coordinators, who are well-positioned to handle the specificities of their regional data collection systems, as well as identifying new data sources which may be interesting for Copernicus. Moreover it has to work closely with other European (EMODNET, SEADATANET, ICES) and international (GODAE, US/NCEI WOD) services and initiatives.

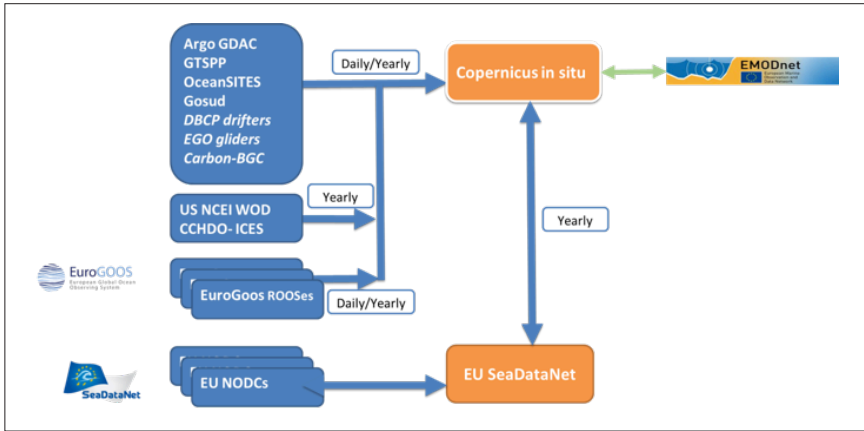

Fig. 2. INSTAC up-stream data flow for NRT and REP products and downstream link with EMNODNet-physics.

3. Products

3.1 Product catalogue and documentation

Mercator-Ocean maintains a catalogue of CMEMS products. This includes the description of the prediction products elaborated by the Marine Forecasting Centres (MFCs) and the Ocean Observing Products elaborated by the Thematic Assembling Centres (TACs). Consequently, the in situ ocean observing products elaborated by INSTAC are described in this central catalogue: <http://marine.copernicus.eu/services-portfolio/access-to-products/> (Select "product with depth level").



Fig. 3. CMEMS catalogue with focus on situ products.

The catalogue part dedicated to the in situ products is fed by the INSTAC product manager. A paper document also describes all the CMEMS products: <http://marine.copernicus.eu/wp-content/uploads/catalogue-cmems.pdf> . Each INSTAC product is documented with 2 types of documents: 1.PUMs: Product User Manuals 2.QUIDS: Quality Information Documents. PUMs describe the way to access the product while QUIDS describe the way the product has been elaborated and validated.

3.2 INSTAC products

INSTAC provides three types of products:

- NRT products (Near Real Time): In the in situ domain, near real-time data may have several meanings: 1.data that circulate from the originator to the data centre from a few hours to no later than 30 days after data collection (definition of the WMO –World Meteorological Organization) 2.data acquired by continuous, automatic and permanent observation networks 3.data that have been passed through an initial quality control check. Within INSTAC, NRT products are updated continuously and integrate observations, often acquired by automated platforms, received within a few hours or days from acquisition, that passed through automated Quality Control procedures. Their quality can be later enhanced by using more accurate quality checks and/or calibrations. The data may be then re-submitted as delayed mode data.
- REP products (REProcessed): These products are historical products , updated on a yearly basis from best quality data recovered either through SeaDataNet National Oceanographic Data Centres (NODC), or JCOMM networks Global Data Centres, or EuroGOOS ROOS providers, or international databases such USA/NCEI or ICES. Additional quality checks as well as regional consistency are performed with scientists and erroneous or suspicious observations are flagged. The most advanced REP product is the Global T&S product (INSITU_GLO_TS_REP_OBSERVATIONS_013_001_b also called CORA) – see this EuroGOOS conference paper from T.Szekely and al.- and the surface current product (INSITU_GLO_UV_L2_REP_OBSERVATIONS_013_044)
- From Global T&S REP product climate indicators such as Global Heat Content Indicator (GLOBAL_REP_PHY_001_021) can be processed. Such products are important for the Ocean State Reports issued annually by CMEMS.

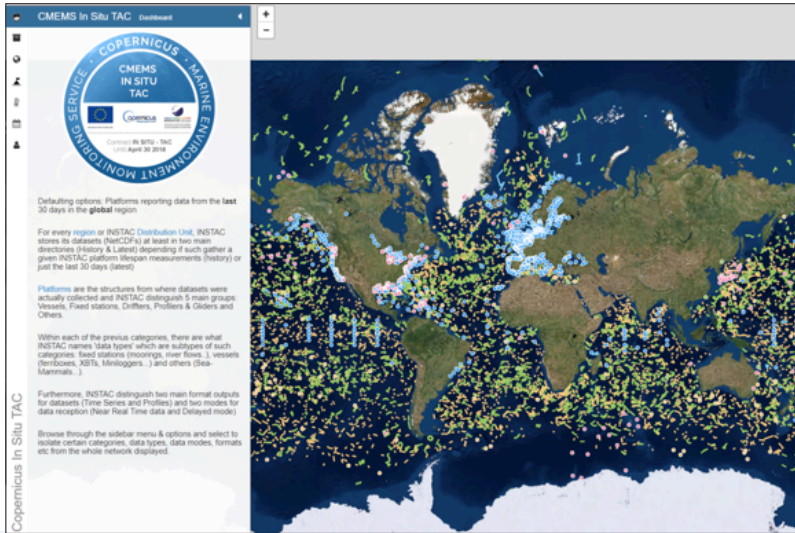

Fig. 4 Latest Month of data from INSITU_GLO_NRT_OBSERVATIONS_013_030 product www.marineinsitu.eu.

3.3 Service Evolution

INSTAC has steadily evolved in its successive versions, and there is a clear development roadmap towards the future: the initial version, **Version 1 (2015)**, was the heritage of *MyOcean suite of projects* with seven NRT products for temperature, salinity, current, sea level, oxygen, chlorophyll parameters and seven REP products for Temperature and Salinity covering 1990-2014. These REP products have been updated yearly and the latest year has been added to the time serie.

Since **Version 2 (2016)**, one surface current REP product designed for reanalysis purposes, integrates the best available version of in situ data for ocean surface currents for the period 1990-2016. The data are collected from the Surface Drifter Data Assembly Centre (SD-DAC at NOAA AOML) completed by European data provided by EUROGOOS regional systems and national systems by the regional INS TAC components. All surface drifter data have been processed to check for drogue loss.

Since **Version 3 (present)** the T&S REP product for the Global Ocean is a merged product between the V1 CMEMS product and ENACT4 product managed by UKMO. The coverage in time and space has been enhanced as well as the assessment method that took the best of each process to provide a product that both serve the research and the operational user needs. It covers 1950-2015.

For Version 4 (2018), seven WAVE REP products will aggregate long time series assessed in delayed mode from WAVE mooring operators covering the period 1990-2016. One BGC REP product for oxygen and chlorophyll parameters will aggregate long time series assessed in delayed mode by platform operators for the period 1990-2016. Whenever possible the consistency between the different platforms will be assessed by a scientist.

With Version 4, CMEMS will reach the end of phase 1 of the initiative. Mercator planned a phase 2 for the CMEMS. This should be officially launched through future calls for tender. They will be related on evolutions and improvements of the models and of the data services *inter alia*.

4. Monitoring the service

Providing an operational or pre-operational service implies the necessity of an accurate monitoring of the service delivery. To reach this objective, INSTAC is developing KPIs (Key Performance Indicators). They allow to monitor the INSTAC activity in terms of data flowing.



Fig. 5. KPI monitoring page from CMEMS INSTAC WWW site.

5. Service Desk Management

As the INSTAC is run as a pre-operational system, a service desk has been set up. The service desk make the links: 1. Between the global CMEMS service desk (hosted by Mercator) 2. Between INSTAC external data providers and the INSTAC 3. Between the INSTAC and the final data users. The address of the INSTAC service desk is cmems-service@ifremer.fr

6. Conclusion

The IN SITU TAC of CMEMS provides a quite unique one stop shopping for ocean in-situ data for operational oceanography needs. As the area of operational oceanography is evolving quickly and continuously, the data management dedicated to in-situ near real time is continuously adapting its activity. The next steps will have to take into account new observation platforms such as tide gauges, HR radar, VM-ADCP... and new parameters (enhanced biogeochemical data management).

The consolidation and sustainability of the global and regional in situ observing systems remain a strong concern. There are critical sustainability gaps and major gaps for biogeochemical observations (e.g. carbon, oxygen, nutrients, Chl-a). New mechanisms need to be set up between the EU and member states to address them. Mercator Ocean as the EU delegated body for the Copernicus Marine Service is working with European Environment Agency, Euro-Argo ERIC and EuroGOOS in the framework of a future European Ocean Observing System (EOOS) to consolidate and improve global and regional in situ observing systems.

Acknowledgements

The CMEMS INSTAC is developed as part of a Delegation Agreement between the European Commission and Mercator Ocean under the In Situ Thematic Assembly Centre (2015).

CORA 5.0: GLOBAL IN SITU TEMPERATURE AND SALINITY DATASET

T. Szekely ⁽¹⁾, J. Gourrion ⁽¹⁾, S. Pouliquen ⁽²⁾ and G. Reverdin ⁽³⁾

⁽¹⁾ IUEM, UMS3113, CNRS-UBO-IRD, Plouzané, Brest

⁽²⁾ IFREMER, Plouzané, France

⁽³⁾ CNRS-INSU, UMR7159, LOCEAN/IPSL (CNRS-UPMC-IRD-MNHN), Paris, France

Abstract

The ability of the scientific community to monitor and understand the oceanic variability is widely based on the quality and the availability of ocean measurements. The particular feature of the CORA dataset (Coriolis Ocean Dataset for Reanalysis) is to distribute all types of in situ temperature and salinity measurements with a maximal sampling, including high frequency profilers (Argo, CTD, etc...) surface and sub-surface timeseries (Thermosalinographs and surface drifters, etc...). The current version of the CORA dataset (CORA5.0) stands out from the previous version by including millions profiles from the historical period (1950-1990) and the addition of year 2015 profiles from Coriolis. A very careful validation process is performed on the CORA measurements since the probably erroneous profiles are individually checked by an oceanographer which changes the data quality flags if necessary. This work flow reduces the amount of unnecessary flags leading to a better estimation of the ocean variability. The CORA dataset is distributed by the Copernicus Marine and Environment Monitoring Service online catalogue: <http://marine.copernicus.eu/services-portfolio/access-to-products/>

Keywords: global dataset, in situ, temperature and salinity profiles, CMEMS

1. Introduction

A critical field in the ocean studies is to collect, validate and distribute ocean measurements to provide the best working framework for the research community. The CORA dataset is a global delayed-time validated dataset similar to datasets EN4 (Good *et al.*, 2013, www.metoffice.gov.uk) and Word Ocean Database (WOD, Levitus *et al.*, 2013, <https://www.nodc.noaa.gov>). Despite very similar data sources, differences in the data organisation leads to divergences in the distributed datasets. In this environment the CORA dataset stands out by distributing a dataset closer to the actual measurements, with a full resolution, a careful validation at all levels and a maximized number of profile distributed.

We will first list the data sources of the CORA measurements in section 2. An overview of the dataset structure and a comparison with EN4 and WOD is given in section 3. A description of the CORA data space and time repartition will be given in section 4. The measurements quality control procedure will be described in section 5. A discussion on the data validation results is given in section 6.

2. Data providers

The CORA 5.0 dataset is an incremental version of the previous CORA datasets, distributed by COPERNICUS Marine Environment Monitoring Service (CMEMS). Most of the CORA profiles are first collected by the Coriolis data centre.

Coriolis data Centre is a Global Data Assembly Centre (DAC) for the Argo program (Roemmich *et al.*, 2009). It collects Argo profiles from the regional Data Assembly Centres (DACs) and distributes them to the community. Coriolis also collects XBTs, CTDs and XCTDs measurements from French and Europeans research programs as well as from the Global Communication System (GTS), Voluntary Ship System (VOS), subtropical moorings measurements (TAO/TRITON/RAMA/PIRATA programs from the PMEL). Major efforts have also been made to include smaller datasets to the Coriolis dataset such as the ITP and CTD profiles from the ICES program, Sea Mammals measurements and Surface drifters. Delayed time mode measurements have also been integrated from the Word Ocean Database (WOD13) and the French Science Hydrographique de la Marine (SHOM), covering the period 1950 to the present.

Finally a comparison of the CORA profile positions with the EN4 dataset (www.metoffice.gov.uk) has shown that some of the profiles distributed in EN4 were not in CORA previous versions. Within CMEMS, a partnership with the EN4 teams was instrumental to identify and to import most of these profiles. Over 5 millions profiles have been imported this way, covering the period 1950-2015. However, for the measurements being directly imported from the EN4 database, the seawater pressure measurement is not provided, a water depth being distributed instead and the profiles maximum vertical levels is set to 400 instead of the full resolution while integrated

from WOD or National Oceanographic Data Centers (NODCs). Those issues will be addressed in the future versions of CORA by recovering the data directly from the data provider.

3. Dataset structure

Table I. Description of the datasets validation and distribution charts.

	DISTRIBUTION	COVERAGE	VALIDATION	DATA TYPES	DISTRIBUTED DATA
CORA 5.0	marine.copernicus.eu	1950-2015	<ul style="list-style-type: none"> - All levels - Semi automatic error detections - Visual control 	<ul style="list-style-type: none"> - Profiles - Timeseries 	<ul style="list-style-type: none"> - All profiles and timeseries - Associated flags
EN4	metoffice.gov.uk	1900-2015	<ul style="list-style-type: none"> - 400 levels max - Automatic error detections 	<ul style="list-style-type: none"> - Profiles only 	<ul style="list-style-type: none"> - Best profiles - Meta profiles - Data flags
EN4	nodc.noaa.gov	1772-2015	<ul style="list-style-type: none"> - Standard levels only - Automatic error detections 	<ul style="list-style-type: none"> - Profiles - Timeseries 	<ul style="list-style-type: none"> - All profiles - Standard levels flags

Table 1 gives an overview of WOD13, EN4 and CORA 5.0 dataset structure and distribution. It shows the different ways chosen to validate and distribute the measurements. Despite a data distribution beginning only in 1950, the CORA dataset stands out by providing measurements with a full resolution and validated at all levels. In addition to that, the CORA validation framework is based on the detection of probably erroneous measurements by automatic tests and the visual control of the detected profiles by an oceanographer. Last, it provides not only profiles at the measurement levels but also timeseries of surface and sub-surface measurements such as surface drifters temperature and thermosalinographs providing worldwide high-frequency temperature and salinity measurements.

4. Dataset description

The different data types in CORA vary widely in time (Fig. 1). Most of the profiles measured before 1965 are mechanical bathythermographs (MBT) measurements or bottle-sampled measurements. Between 1970 and 1990, the most common instrument is the expendable bathythermographs (XBT), developed during the 60s and widely used by the community. Most of the XBT profilers deployed during this period are T4 type sensor, measuring temperature above 460 meter depth. The development of the Sippican T-7 instrument with a maximum depth of 1000m slowly increases the measurement number below the sub-surface during the 1980s (see Fig. 2 for the dataset measurements distribution with depth). The conductivity temperature

depth sensor (CTD), a popular instrument capable of measuring both temperature and conductivity leading to an accurate estimation of sea salinity and sea water density was developed in the early 1960. The amount of CTD profiles in the CORA dataset slightly increases then and reaches a plateau of about 20000 yearly profiles in the early 1990s.

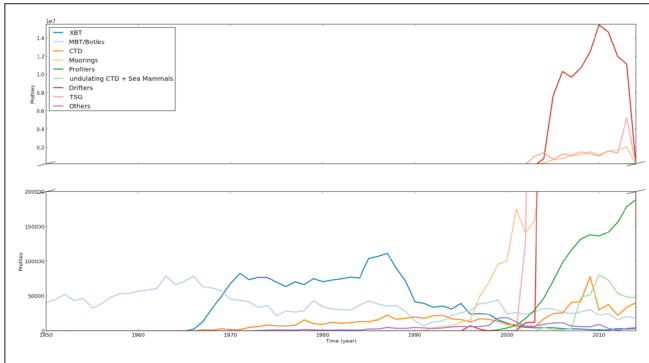

Fig.1. Yearly number of distributed profiles, sorted by instruments types.

The measurements provided are however deeper than the previous decade, leading to a better coverage below 500m depth (Fig. 2).

The number of profiles then exponentially increases since the development of the TAO/RAMA/PIRATA equatorial mooring program in the mid-late 1990s. The ocean sampling rate exploded in the early 2000 thanks to the development of autonomous profilers and the worldwide Argo program.

See the simultaneous increase in the number of measurements below 1000m depth.

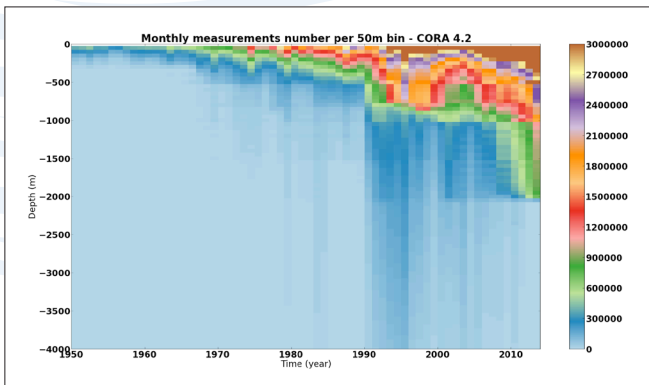

Fig. 2. Yearly number of distributed measurements per 20 meter depth bin.

In the Antarctic Ocean, the sampling rate increases in 2005-2006 as a consequence of Argo deployment south of 55°S and the deployment of sea mammals mounted CTD in the vicinity of the Kerguelen islands (Roquet *et al.*, 2011).

It must also be emphasised that a fraction of the number of profiles sharp increase of the early 2000s is a consequence of the development of high frequency measurements devices such as the ocean drifters, the thermo salinographs (TSGs) or towed undulating CTD (gliders, scanfish, seasoar...). Each towed undulating CTD profile and each independent TSG or drifter measurement is treated as an independent profile in the CORA dataset. This lead to a more homogeneous dataset file structure but it can be misleading when estimating the number of profiles. This is also true for the mooring measurements since some of them are high frequency devices. A consequence is also the increase of measurements originating from mooring data at 250m depth and 500m depth and from TSG and drifting buoys at the surface.

5. Data quality control

The Coriolis data centre checks the data quality and consistency, in order to provide to the scientific community a consistent global dataset of validated measurements.

A description of the near-real time dataset validation in the Coriolis data centre is given by Cabanes *et al.*, 2013.

First, a set of near-real time validation tests is performed within a few days after measurements reception. An additional control of the Argo profiles is performed thanks to an objective analysis on a daily basis (Gaillard *et al.*, 2009). The detected profiles are then visually checked by a PI to flag the erroneous measurements. A quality control based on altimetry comparisons is also performed on a quarterly basis on Argo data to improve the real time validated dataset (Guinehut *et al.*, 2009). A PI investigation is also performed on the altimetry detected profiles.

The corresponding dataset is distributed by the CMEMS catalogue and regularly updated.

The CORA dataset validation is a delayed time validation performed each year with sharper tests than the real time mode validation. A PI visual investigation is performed at each step to reduce the number of erroneous flags.

The first quality check considers the detection the well-known instrumental errors: spikes, constant value, absurd value, etc...The following step of the CORA data validation is designed to detect the profiles diverging from the known ocean variability. Each temperature and salinity profile is compared to a minimum and maximum reference field. The field is a gridded mesh of 1 degree resolution horizontal hexagonal cells of 20m depth. The higher and the lower temperature (resp. Salinity) ever measured by

Argo floats on the period 2002-2013 in a given cell is compared to the profile sampled in this cell. The profile containing measurements exceeding the reference values are checked by an oceanographer.

Fig. 3 shows the position of the profiles flagged during this process.

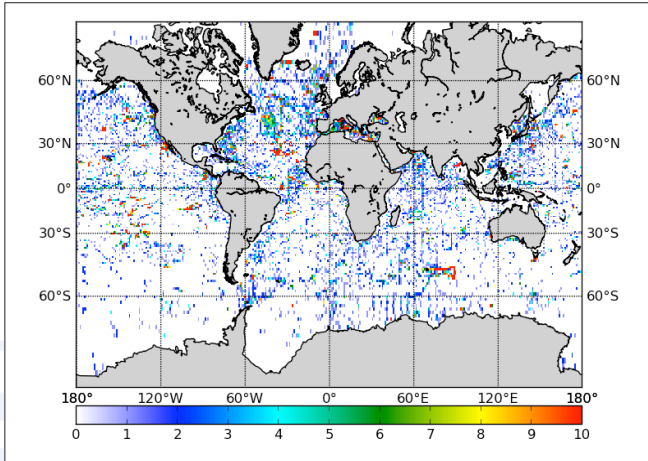

Fig. 3. Number of profiles flagged during the delayed time mode quality control process gridded in a 1° per 10 grid cells.

6. Discussion on the data validation

A robust rather simple way to confirm the global ocean data flag is to check the efficiency of the dataset to estimate the ocean variability.

Two ocean average 0-10m depth temperature estimations are calculated: a raw estimation which takes into account every measurement without considering the ocean flags and a flagged estimation which only consider the good and probably good quality control flags.

The global ocean is divided in 1° per 1° grid cells with 10m depth from surface to 700m depth. For each cell, the mean temperature measured by each profile located in the cell is taken into account. An interpolated field is calculated following the method presented by Forget and Wunsch 2007.

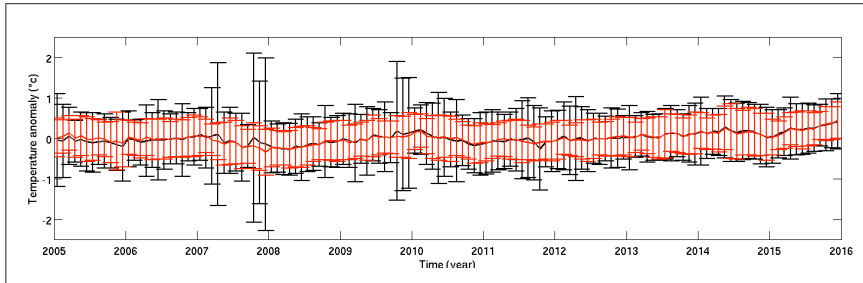

Fig. 4. Mean temperature anomaly between 60°N and 60°S estimated with the CORA dataset.

Fig. 4 gives the mean temperature anomaly in the top 10 meters of the ocean. It shows that the CORA delayed time mode quality control flags allow to reduce significantly the ocean temperature anomaly error bar to an almost constant level with a low impact on the anomaly signal. As a consequence, one can consider that the CORA validation process is consistent within time while limiting the over-flagging to a low level.

References

- Cabanes, C., Grouazel, A., Von Schuckmann, K., Hamon, M., Turpin, V., Coatanoan, C., Paris, F., Guinehut, S., Boon, C., Ferry, N., De Boyer Montegut, C., Carval, T., Reverdin, G., Pouliquen, S., Le Traon, P.-Y. (2013). The CORA dataset: validation and diagnostics of in situ ocean temperature and salinity measurements. *Ocean Science*, 9, 1-18.
- Forget, G., Wunch, C. (2006). Estimated global hydrographic variability. *Journal of physical oceanography*, 37, 1997-2008.
- Gaillard, F., Autret, E., Thierry, V., Galaup, P., Coatanoan, C., Loubrieu, T. (2009). Quality control of large Argo datasets, *Journal of Atmospheric and oceanic Technology*, 26, 337-351.
- Guinehut, S., Coatanoan, C., Dhomp, A.-L., Le Traon, P.-Y., Larnicol, G. (2009). On the use of satellite altimeter data in Argo quality control. *Journal of Atmospheric and oceanic Technology*, 26, 395-402.
- Good, S. A., M. J. Martin and N. A. Rayner, (2013). EN4: quality controlled ocean temperature and salinity profiles and monthly objective analyses with uncertainty estimates, *Journal of Geophysical Research: Oceans*, 118, 6704-6716
- Levitus S., Antonov J., Baranova, O., Boyer T., Coleman C., Garcia H., Grodsky A., Johnson D., Locarnini R., Mishonov A., Reagan J., Sazama C., Seidov D., Smolyar I., Yarosh E., Zweng M. (2013) The World Ocean Database, *Data Science Journal*, 12, WDS229-WDS234.

Roemmich, D., Johnson, G., Riser, S., Davis, R. Gilson, J., Owens, W., Garzoli, S., Schmid, C., Ignaszewski, M. (2009). The Argo program: Observing the global ocean with profiling floats. *Oceanography*, 22, 34-43.

Roquet, F., Charrassin, J.-B., Marchand, S., Boehme, L., Fedak, M., Reverdin, G., Guinet, C. (2011). Delayed-mode calibration of hydrographic data obtained from animal-borne satellite relay data loggers. *Journal of Atmospheric and oceanic Technology*, 28, 787-801.



VIRTUAL ACCESS ACTIVITY IN JERICO-NEXT: GUIDING USERS TO RELEVANT SERVICES AND DATA

V. Créach ⁽¹⁾, A. Novellino ⁽²⁾, K. Collingridge ⁽¹⁾ and M. Devlin ⁽¹⁾

⁽¹⁾ Centre for Environment, Fisheries and Aquaculture Science (CEFAS), Lowestoft, UK, NR33 0HT Veronique.creach@cefas.com

⁽²⁾ ETT S.p.A., via Sestru 37, 16154 GENOVA, Italy

Abstract

The objective of JERICO-NEXT consists of strengthening and enlarging the European network for the provision of operational services to deliver timely, continuous and sustainable high quality environmental data and information products related to the marine environment in European coastal seas. Under Horizon 2020, Virtual Access (VA) is a new activity in European-funded projects. This activity guaranties free access of information to scientists to carry out not only high-quality research but also promotes improvement of existing services and potentially the development of new services for nautical communities, maritime and port authorities, local decision makers, economic agents, schools and the general public. Under this activity JERICO-NEXT has developed a web portal for guiding users to data and services through a list of providers as well as a close link to EMODnet-Physics. The activity is assessed not only on data visibility, access, format, downloading time, terms of use and interoperability of services but also on quantity, geographical distribution of users and, whenever possible, information/statistics on scientific outcomes (publications, patents, etc.).

Acknowledging the use of the infrastructure. The results of the assessment showed that if all the virtual access providers delivered good quality data, only some of them have products available for services. However, most of the VA providers deliver data to European data portals such as EMODnet or CMEMS which explain the excellent score of visibility, accessibility, and performance indicators giving a good opportunity to create new services for industry, policy makers and societal sector.

Keywords: JERICO-NEXT, Virtual infrastructures, assessment template, availability indicators, data.

1. Introduction

In the last decades, marine observing systems have been implemented in coastal and shelf seas around Europe. Their purpose is mostly to answer local/regional monitoring and oceanographic research demands. However, heterogeneity of monitoring methods and a geographical dispersion often limit development of a coherent network. Indeed, observations are often driven through short-term research projects, therefore the sustainability of observing systems is not guaranteed. One of the main challenges for the European marine research community is now to increase the consistency and the sustainability of these dispersed networks and infrastructures by integrating their future within a shared pan-European framework. The aim of JERICO-NEXT, as a network of coastal observatories, is to ensure regular and standardized observations to provide long term time-series of high-quality biogeochemical, physical and biological data. Therefore, combined operational capabilities, innovation and sustainability for high quality European networking research are needed. In the project, three workpackages aim to provide robust and high-quality information to decision makers in governments and agencies, private sector and civil society for improving or promoting services. The environmental information consists on high frequency and in real-time data provided as well as single points and archives. They are freely available with or without registration from the provider websites, the JERICO-NEXT portal and from EMODnet data systems (Physics and Chemistry) as well as other data management infrastructures, e.g. Copernicus Marine (CMEMS) or EuroGOOS ROOSs data portal. To estimate the flow of information in the different virtual infrastructures, a template has been developed to report the number of visits, number of downloaded data sets, type of users, geographical distribution of users and, whenever possible, information/statistics on scientific outcomes (publications, patents, etc.) acknowledging the use of the infrastructure when it is available. Availability indicators (AIs) providing an understanding of the readiness and service performance of the JERICO-NEXT VIs have been also applied to complete the assessment of the primary link of the providers and listed in JERICO-NEXT Virtual Access (VA).

2. Methods

2.1 The virtual Access providers

The VA activity presents 15 Virtual Access (VA) providers (see table below) and 16 virtual infrastructures (VIs). VIs are characterised by a high diversity of platforms available delivering physical, chemical and biological parameters. The platforms can be divided in 6 categories (Ferry/ship; buoy/drifter, HF Radars, station, gliders, cables). The most common parameters measured are temperature, salinity, chlorophyll/fluorescence, and turbidity. Only 4 virtual infrastructures propose biological data on plankton, invertebrates, fish, but also mammals (seals) and primary production (FRRF). Most of the virtual infrastructures present real-time measurements but the users can also have access to data from discrete samplings and a sediment Profile Imagery Software (SPI-S). The 16 virtual infrastructures are described in detail in JERICO-NEXT website: <http://www.jerico-ri.eu/virtual-access>.

2.2 Assessment template and availability indicators (AIs)

An assessment template has been developed for a periodic reporting of the activity of the VIs. All the virtual access providers have the obligation to fill it, using one of a statistical tool such as Google Analytics. The number of visits, number of downloaded data sets, type of users, geographical distribution of users and, whenever possible, information/statistics on scientific outcomes (publications, patents, etc.) acknowledging the use of the infrastructure when it is available must be reported. Additionally, some availability indicators (AIs) i.e. a methodology to assess the degree to which the datasets are discoverable, accessible, ready for use, and downloadable (either directly or indirectly) from the JERICO-NEXT VIs have been applied. The availability indicators provide then, an understanding of the readiness and service performance of the infrastructure providing access to data. The three classes of availability indicators are: 1) Visibility (VI) which is the ability to get quickly on the appropriate site delivering the desired datasets and/or to reach the data provider when needed especially for a non-expert, 2) Accessibility (AC) which plays a fundamental role in the capacity of an infrastructure to support efficiently a multi-node distributed system, making available: manual ordering, on-line downloading, on-line downloading and advanced services (services or software to download for processing and viewing data), 3) Performance (PE) which is the ability of a system to keep operating over time and to meet real time operational conditions related to service performance on reliability and responsiveness. The visibility (VI), accessibility (AC) and performance (PE) indicators of the VIs were calculated for the primary link in JERICO-NEXT VA, for JERICO-NEXT data portal in EMODnet Physics, for EMODnet Physics, and for CMEMS. Each VI was given a score from Low (0), Medium (1) to High (2) per indicator. The score of each VI for each AI was added and a percentage was calculated as a ratio of the maximum score possible.

3. Results

The oldest VIs in JERICO-NEXT has been set up in 2008 (POSEIDON, <http://www.poseidon.hcmr.gr>) and the most recent in 2017 (ÜTO, <http://swell.fmi.fi/Uto/latest.html>). All the VIs have an introduction page in English. The VA providers used seven different statistical tools to fill the assessment template which explains the different levels of information collected on each VI. Only 2 criteria could be filled by all VA providers: the number of visitors and the country of visitors. For those who could answer, 40% to 77% of the data and products were mainly used in science, and not more than 12% by the private sector. However, most of the VA providers could not answer because of the lack of appropriate system in place to deliver the answer.

The Table 1 shows the scores for the 6 AIs for visibility, accessibility and performance from primary link, JERICO-NEXT data portal in EMODnet Physics, EMODnet Physics and CMEMS. Table 2 shows the evolution of the AIs between February and July 2017. In JERICO-NEXT VA, AIs reflected an update of the VIs link and landing page by the providers, an increase of the accessible plots or data in a common or standardised format as well as an increase of data flow to EuroGOOS ROOS data portal, CMEMS

and EMODnet Physics (Table I). However, the interoperability of services as well as data downloads were low 43% and 68%, respectively (Table II). JERICO-NEXT data portal (under the EMODnet Physics) showed a big progress in terms of visibility (+189%) as well as interoperability services (194.1%). However, some VIs were missing and should be soon incorporated if the data format is compatible with EMODnet requirements. The JERICO-NEXT data portal under EMODnet Physics was almost reaching the top score for VIs visibility, accessibility as well as in EMODnet Physics where the providers or the VI dataset (e.g. platform) were already easily. However, some of the listed platforms are still missing in EMODnet Physics (e.g. UTO, NIVA NRS) and some are still difficult to find (NIVA NorFerry, and SYKE-Alg@line). The datasets available in EMODnet Physics are in a standard format and downloading services take a few minutes. JERICO-NEXT VIs were not easily identifiable into the CMEMS products catalogue and if the datasets are available in CMEMS, they are in a standard format and easy to download after registration.

Table I. Evolution of the availability indicators calculated between February and July 2017.

ASSESSMENT INDICATORS	DESCRIPTION	PRIMARY LINK FROM GOOGLE	JERICO-NEXT VA PORTAL	EMODNET	CMEMS
AI.VI.1	VI and VI data Visibility	+ 38.9%	+ 189.3%	+ 22.2%	-
AI.VI.2	Term of use and citation	+ 100%	+ 62%	+ 131.6%	-
AI.AC.1	Data Access	+ 35.5%	+ 52.8%	+ 17.3%	+37.5%
AI.AC.2	Data Format	0%	0%	0%	0%
AI.AC.3	Interoperability Services	+ 53.6%	+ 194.1%	33.3%	0%
AI.PE.1	Ability to access/download data in a fixed time window	+ 65.8%	0%	0%	0%

Table II: Availability indicators calculated for the 16 Virtual infrastructures for assessing the visibility (AI.VI), accessibility (AI.AC), and performance (AI.PE) expressed in percentage. For visibility, accessibility and performance, the VA providers were scored as 0=low, 1=medium, 2=high. All the scores per indicator have been summed and related to the maximum score.

ASSESSMENT INDICATORS	DESCRIPTION	PRIMARY LINK	JERICO-NEXT DATA PORTAL	EMODNET	CMEMS
AI.VI.1	VI and VI data Visibility	100%	81%	88%	-
AI.VI.2	Term of use and citation	83%	81%	88%	-
AI.AC.1	Data Access	80%	81%	88%	77%
AI.AC.2	Data Format	100%	100%	100%	100%
AI.AC.3	Interoperability Services	43%	100%	100%	100%
AI.PE.1	Ability to access/ download data in a fixed time window	68%	100%	100%	100%

4. Discussion

The diversity of the VIs in JERICO-NEXT VA makes difficult any assessment on the flow of information used by policy makers, private or societal sector. Primarily set up to feed scientific needs, the VIs are still heavily used for science purposes. JERICO-NEXT promotes the links with other European Data Infrastructures (EDIs) such as EMODnet, and CMEMS, aiming to increase the visibility and the use of information from JERICO-NEXT VIs by a larger community of end-users. The EDIs present the advantages of a large catalogue of datasets and products covering a large geographical area. They also provide good visibility, good interoperational services of standardised data sets and an easy download process which are the keys for success. However, it is important that VA providers keep track of the use of their data and products not only for acknowledgment purposes but also to create one to one relationship with public or private partners if needed. The results from the assessment template suggest that only very few of the VA providers have already an identification and traceability system in place. The assessment template also highlights the geographical distribution of users who are mainly from the country of origin of the VIs. This trend is also observed in the statistics of the EDIs suggesting that the data and products are mainly used by national users. If one of the purposes of the EDIs is to be able to use the datasets and products available in a holistic approach, it seems that the objective has not yet been achieved and more developments are needed. The assessment template requested by the European community gives a very little information because of a lack of harmonised statistical tools and system to trace the information flow. This problem could be easily solved by setting up a registration system already in place by some of the VIs without any restriction on data or products availability and a Digital Object Identifier (DOI) for the data. The availability indicators are another approach for assessing the activity of the VIs. Based on a simple scoring system, they highlight in JERICO-NEXT the efforts of the VA providers to make their data more visible, more reliable from their primary link or through a EDIs during the first 18 months of the project. The combination of the two types of assessing process could be powerful in the future to guide the development of VIs for a better use of the data and products to create new services.

Acknowledgements

The virtual access activity as well as the data assessment were funded by JERICO-NEXT (H2020- Integrating and opening existing national and regional research infrastructures of European interest, 654410).

SOCIETAL BENEFITS FROM OBSERVING AND MODELLING SYSTEMS – PILOT ACTIONS IN IRELAND IN THE FRAMEWORK OF THE ATLANTOS PROJECT

T. Dabrowski, C. Cusack, K. Lyons, J. Silke and E. O'Rourke

Marine Institute, Rinville, Oranmore, Co. Galway, Ireland. tomasz.dabrowski@marine.ie

Abstract

Work Package 8 of the EU H2020 funded AtlantOS project aims to deliver a suite of downstream marine data products and services targeted at issues of societal concern, such as climate, disasters, ecosystems, health and water. The Marine Institute, together with AtlantOS partners, is focused on three of the seven AtlantOS WP8 feasibility studies focused on harmful algal bloom alerts, coastal flooding/storm surges and offshore aquaculture siting. The downstream data products/services developed integrate data from existing services and this paper reports on the developed systems:

- The HAB warning system amalgamates ocean observing (in situ, satellite) data and model forecasts, which then undergo expert interpretation (decision support) to produce a weekly HAB bulletin for the aquaculture industry.
- The Marine Institute operational modelling system is capable of providing a 3-day storm surge forecast for Irish coasts; an overview of the system and its skill is provided, with a particular emphasis on the winter storms of 2013 – 2014.
- Developed products for offshore aquaculture siting consist of model-derived data layers of wave heights and current velocities, combined with a bathymetric dataset. A weather window tool will be developed to provide end users real-time access to sea state observations and model forecasts in order to allow aquaculturists plan day to day farm operations.

Keywords: AtlantOS, modelling, harmful algal blooms, aquaculture, storm surges

1. Introduction

Work Package 8 of the EU H2020 funded AtlantOS project aims to deliver a suite of downstream marine products and services targeted at issues of societal concern, such as climate, disasters, ecosystems, health and water. The main objective is to enhance the safety of coastal communities and promote economic development in key emerging marine and maritime sectors through better decision support tools and resource assessment. Numerical ocean models and observational programmes are essential components in the development of these downstream products/services. The Copernicus Marine Environment Monitoring Service is a significant enabler of these services. An overarching aim of the AtlantOS project is to achieve transition from loosely coordinated set of existing ocean observing activities producing fragmented, often monodisciplinary data, to a sustainable, efficient and fit-for-purpose Integrated Atlantic Ocean Observing System. WP8 and this paper demonstrate the societal benefits arising from this integration by providing examples of specific downstream services/data products.

The Marine Institute, together with AtlantOS partners, is focused on pilot actions (feasibility studies) related to harmful algal bloom (HAB) alerts, coastal flooding/storm surges and offshore aquaculture siting. This paper reports on the current status of the developed systems that deliver downstream services/data products.

2. Description of the models

This section describes the numerical models that support the presented downstream services. Observational data that forms part of these services is described in relevant subsections of section 3 along with the description of individual services.

The 3D operational models implemented by the MI (Marine Institute) are based on the Regional Ocean Modelling System (ROMS) which is a free-surface, hydrostatic, primitive equation ocean model described in Shchepetkin and McWilliams (2005). ROMS uses orthogonal curvilinear coordinates on an Arakawa-C grid in the horizontal while utilizing a terrain-following (sigma) coordinate in the vertical. The prognostic variables of the hydrodynamic model are surface elevation, potential temperature, salinity and horizontal velocities.

The local coastal models of the southwest and midwest coasts of Ireland, hereafter called the Bantry Bay and the Connemara models respectively, have a horizontal grid spacing of 200 – 250m and 20 vertical levels. The models are nested offline in a regional North East Atlantic (NE_Atlantic model) model run operationally at the Marine Institute. Time series of water levels, 2D and 3D momentum, temperature and salinity are provided every 10 minutes at the open boundaries. Both local coastal models are initialised from the parent model output interpolated onto child grids. Surface forcing is taken from the 0.125 degree European Centre for Medium Range Weather Forecasts (ECMWF), available at three-hourly intervals, and the model interpolates

data onto its current time step. Heat fluxes are calculated from the bulk formulae and surface freshwater fluxes are obtained from the prescribed rainfall rates and the evaporation rates calculated by the model. Freshwater discharges from rivers are included as climatologies.

The parent model domain (NE_Atlantic) covers a significant portion of the North-West European continental shelf at a variable horizontal resolution between 1.2 and 2.5km and with 40 sigma levels. It is nested within the 1/12° Copernicus (GLOBAL_ANALYSIS_FORECAST_PHY_001_024) model whereby daily values for potential, temperature, sea surface height and velocity are linearly interpolated from the parent model onto the NE_Atlantic model grid at the boundaries and are used for model initialisation. Tide forcing is prescribed at the model boundaries by applying elevations and barotropic velocities for ten major tide constituents, which are taken from the TPX08 1/30° global inverse barotropic tide model. Model domains are presented in Fig. 1.

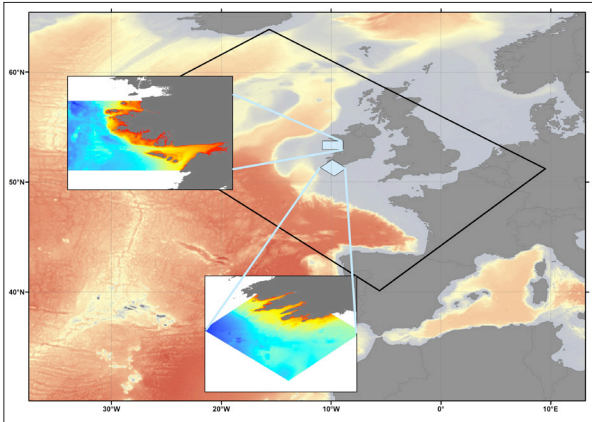

Fig. 1. The MI operational general ocean circulation models domains: (a) NE_Atlantic, (b) Bantry Bay and (c) Connemara.

The authors also developed a wave model based on SWAN (Simulating Waves Nearshore). Two model domains are used. The first model domain encompasses Irish coastal waters from 12.0 to 7.5 W and 50.0 to 56.5 N at horizontal resolution of 0.004 degrees. The second model domain encompasses the North East Atlantic from 38 to 60 N and 1 to 19 W at 0.025 degrees resolution. The models are forced with winds from GFS 0.25 degree forecasts and wave data at the boundaries are from the Wave Watch 3 (WW3) model developed by FNMOG (U.S. Navy Fleet Numerical Meteorology and Oceanography Centre).

3. Downstream services

3.1 Harmful algal bloom warning system

In the context of the AtlantOS project, the objective of this system is to assess harmful algal bloom evolution in EU Atlantic Shelf Seas based on available in situ and satellite data, and available hydrodynamic modelling information.

The user needs can be summarized as follows:

- Early notification of a harmful/toxic bloom (2 - 3 day notice at a minimum);
- Easy to interpret results;
- Support the scientific advice given to regulatory bodies;
- Access to all information in one place to make it easier for local experts to interpret the data and provide early warning notices;
- Alert of high biomass blooms in coastal areas used for leisure (e.g. beaches).

A HAB warning system was developed to disseminate information to a wide audience with easy to interpret plots and explanatory text. The reader is referred to Cusack et al. (2016) and Dabrowski et al. (2016a, b) for details on products developed from physical forecasts that are part of the HAB warning system. The data products (maps, plots and model simulations) are collated and text is added by local scientists to provide a big picture view of HAB distributions around Ireland. The pilot action for Ireland uses a 3D hydrodynamic model that provides a three day forecast that highlights local physical oceanographic events such as upwelling. These simulations along with other data products (spatial and temporal plots, historic accounts etc.) help local scientists to gauge the likelihood of a harmful algal event in the days ahead. A conceptual view of the system is presented below (Fig. 2).

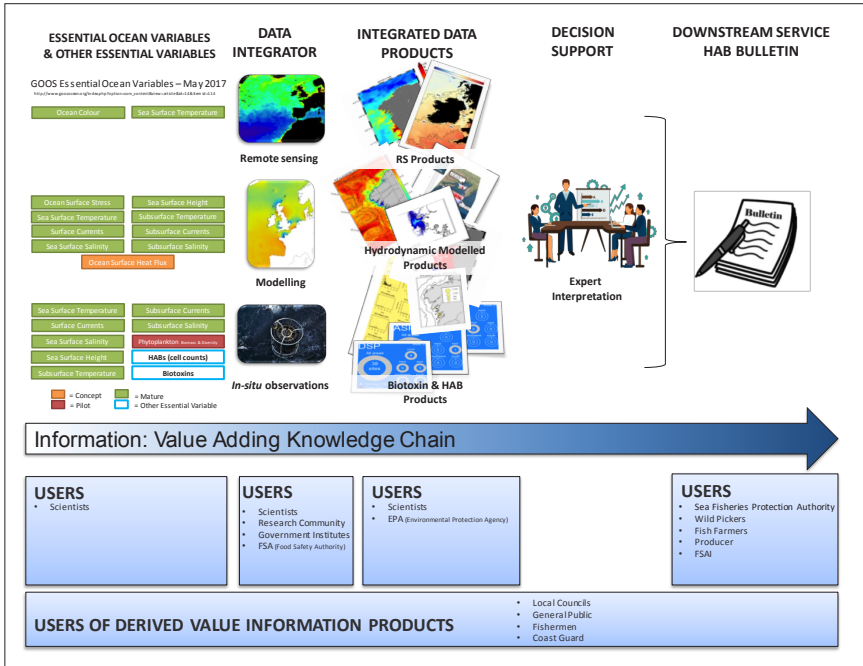

Fig. 2. Schematic diagram of the MI harmful algal bloom components and the value adding process.

In situ data from the National Monitoring Programme for HAB and associated biotoxins are held in a SQL HAB database at the Marine Institute. The data is viewed and explored locally; an R script is used to plot temporal and spatial data. Information gathered is used to describe current and past HAB and biotoxins trends in Irish waters. Surface chlorophyll a and SST satellite data products are sourced from those developed by Ifremer/DYNECO and CERSAT in Brest and NASA1 and the CMEMS portal [www.marine.copernicus.eu]. Matlab and R scripts are run to produce maps and visualise daily and weekly images. A weekly chlorophyll a anomaly is calculated and plotted. Series of figures are generated from the coastal operational models for Bantry Bay and Mizen Head situated on southwest Ireland and for Killary Harbour, a west coast fjord, and a shelf transect off the mid-west coast. The HAB bulletin includes plots with the latest 3-day volumetric flux forecast for vertical transects at the mouth and mid-bay of Bantry Bay and at the mouth of Killary Harbour. Lagrangian particle

tracking model outputs are used to generate maps that depict movement of water masses due to the Irish Coastal Current, water inflows into the embayments and to highlight upwelling/downwelling events. Predictions (3-day) of temperature, salinity and density are also produced to inform local experts, but, are currently not part of the bulletin. More details can be found in Dabrowski *et al.*, (2016a) and Cusack *et al.*, (2016).

3.2 Storm surge forecasts

Any increase in flood frequency or severity due to sea level rise or changes in storminess would adversely impact society. AtlantOS has refined and improved methods of the estimation of extreme sea levels (Horsburgh *et al.* 2017). Global storm surge climatology will also be developed. Horsburgh *et al.* (2017) report on progress to date.

Horsburgh *et al.*, (2017) show that high quality tide gauge data are the best basis for storm surge climate analysis. In Ireland, the MI operates the Irish National Tide Gauge Network. Gauges are distributed along all Irish coasts and water levels are recorded at 6 minute intervals and this allows storm surge analysis to be carried out. The skew surge analysis, carried out under the framework of AtlantOS, is described in Williams *et al.* (2016) and this technique provides a sound statistical basis for storm surge analysis; the Irish tide gauge network data was used in the above research.

Future work of AtlantOS includes running a global fully coupled tide-surge reanalysis model. Regional to local storm surge models, like the one operated by the MI, can be useful for comparison of the model skill between global models and the high resolution local solution. The MI storm surge model (i.e. NE_Atlantic) delivers high accuracy and quality forecasts that are assessed every winter. For example, the winter of 2013-2014 was particularly stormy. Five storm surges $\geq 1\text{ m}$ (maximum height of 1.56 m) occurred within a three week period in the mid-west Irish coast (at Galway Port). Fig. 3 presents the surge RMSE (root mean squared error) calculated for the time period that encompasses these five major storms. If averaged across all analysed tide gauges, the RMSE = 9cm and the bias < -1 cm.

¹ <ftp://ftp.ifremer.fr/ifremer/cersat/products/gridded/ocean-color/atlantic/EUR-L4-CHL-ATL-v01/>

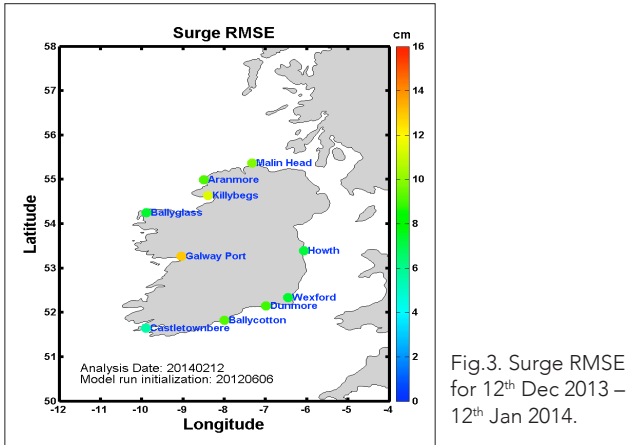

Fig.3. Surge RMSE for 12th Dec 2013 – 12th Jan 2014.

3.3 Offshore aquaculture siting

The information data product developed in this case study highlighted potential aquaculture sites in Irish Atlantic waters based on the predictions of the numerical models described in Section 2.

Thirteen months of simulated model data and a GIS based model approach were used to create the product. GIS raster files were created and extracted in four different layers to view the results spatially. Spatial maps were created offline.

The simple model used the following criteria to create a layer for each variable:

- Water depth ≥ 15 m;
- Maximum tidal velocity of < 1 m/s;
- Maximum significant wave height, max_Hs , < 4 m;
- Ninetieth percentile value of a significant wave height (Hs), $Hs_P90 < 2$ m.

Simple raster analysis was used to apply rules to the individual layers and isolate areas where the above exposure criteria were met (value of 1) or not met (value of zero). The superposition of the four layers was then used to create a new raster – the final model output that presents the locations around the west and southwest coasts of Ireland, where all criteria are met; these are presented in Fig. 4. The above methodology follows Dabrowski et al. (2016b). The reader is also referred to the AtlantOS report (Dale et al., 2017).

Since aquaculture licensing decisions must comply with all EU and national legal requirements, relevant additional information is required by end-users (e.g. decision

makers). Currently, there is a lack of any available site decision tools that could be coupled with the presented modelled product developed for Irish waters. Layered GIS product examples, however, can be viewed on the Irish Marine Data Atlas (link: <http://atlas.marine.ie>) maintained by the MI and include: aquaculture sites, sea cables, security zones around shipping routes, offshore wind farms, oil & gas installations, spawning grounds, feeding/nursery grounds, fishing areas, marine protected areas.

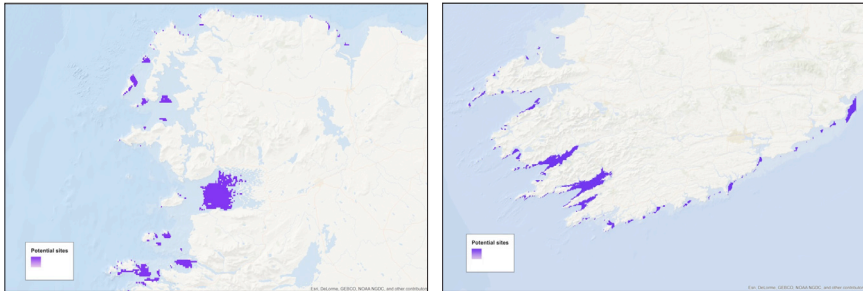

Fig.4. Locations where offshore aquaculture sites could potentially be situated off (a) the west and (b) the southwest coasts of Ireland based on physical variables.

4. Discussion

The HAB bulletin is being delivered by the MI on a weekly basis. The end users were identified and mapped along the value chain. The EMODnet process is followed to ensure ISO standard documentation and scripts and best practices are shared with the community. Future work includes moving towards automation of the bulletin generation. Currently, the HAB bulletin is compiled manually which is a time consuming process. The planned automation of the bulletin should provide easier and quicker access to information products used by local experts who assess the current situation and who produce an outlook of the likely occurrence of HAB events in the days ahead. Other limitations of the current application include the lack of offshore sites that could provide additional information to the alert system on when potentially toxic/harmful phytoplankton are being transported in the ICC toward the Bay. Today's, biogeochemical models are limited in what they can simulate biologically; there is a need for increased community effort to model target HAB species.

Skew surge analysis provides new insight to understanding interactions between tides and surges; this method will be rolled out to a wider global set of tide gauge data. High quality tide gauge data are the best basis for storm surge climate analysis.

Current tools for offshore aquaculture siting presented in this paper focus mainly on sea state suitability for aquaculture operations; environmental monitoring and marine

spatial planning should be included in future tools. More Essential Ocean Variables may be relevant for these future tools whereas stronger end user involvement will also ensure that products are “fit for purpose”. The next steps to improve applications developed for offshore aquaculture siting are to engage more with policy makers responsible for marine spatial planning laws and industry to discuss climate limitations of future planned infrastructure on exposed farmed sites. The criteria used in the modelled information products should also be in line with community best practice (yet to be established) and where possible, a standardised internationally accepted approach taken.

Acknowledgements

This project has received funding from the European Union’s Horizon 2020 research and innovation programme under grant agreement N° 633211.

References

- Cusack, C., Dabrowski, T., Lyons, K., Berry, A., Westbrook, G., Nolan, G., and Silke, J. (2016). Harmful Algal Bloom warning system for SW Ireland. Part II: ASIMUTH-tailored model products, observations. *Harmful Algae*, 53, 86-101.
- Dabrowski, T., Lyons, K., Nolan, G., Berry, A., Cusack, C., and Silke, J. (2016a). Harmful Algal Bloom warning system for SW Ireland. Part I: description and validation of an operational forecasting model. *Harmful Algae*, 53, 64-76.
- Dabrowski, T., Lyons, K., Cusack, C., Casal, G., Berry, A., and Nolan, G. D. (2016b). Ocean modelling for aquaculture and fisheries in Irish waters. *Ocean Science*, 12, 101-116.
- Dale, T., Cusack, C., Ruiz, M., Selvik, J.R., Hjermann, D., Dabrowski, T., Lyons, K., Carr, R. and O’Rourke, E. (2017). Aquaculture site selection report: Report on potential, selected sites for offshore aquaculture along the Spanish, Norwegian and Irish Atlantic coasts. EU H2020 AtlantOS Deliverable 8.2, 39pp.
- Horsburgh, K., Williams, J., and Cusack, C. (2017). Storm surge climatology report. EU H2020 AtlantOS Deliverable 8.1. 12pp.
- Shchepetkin, A.F., and McWilliams, J.C. (2005). The regional oceanic modeling (ROMS): a split-explicit, free-surface, topography-following-coordinate oceanic model. *Ocean Modelling*, 9, 347-404.
- Williams, J., Horsburgh, K. J., Williams, J.A., and Proctor, R.N.F. (2016). Tide and skew surge independence: New insights for flood risk. *Geophysical Research Letters*, 43, 6410-6417.

EMERGING NEEDS ON OPERATIONAL OCEANOGRAPHY TO SERVE SUSTAINABLE DEVELOPMENT IN BALTIC-NORTH SEA

Author: J. She

Danish Meteorological Institute, Lyngbyvej 100, DK-2100 Copenhagen Denmark. js@dmi.dk

Abstract

Capacity of European operational oceanography has been significantly improved in the past decade. In the Baltic-North Sea, cost-effective monitoring technologies, e.g., ferrybox, glider, Argo profiler, HF radar and mooring, have been used for observing the sea. New observations, such as ice thickness, suspended sediment and near coastal sea level etc., are also made available by using satellites, e.g., Sentinels. The transient kilometric scale marine status has been observed, although still gapped, in many parts of the sea. Models for simulating and forecasting ocean physics, sea ice, waves and biogeochemistry are now available both at European and national levels, on a wide range of scales and resolutions, some with data assimilation. The service areas by using such operational product have also been greatly extended in recent years, for blue growth sectors, ecosystem-based management and climate change adaptation and mitigation. Benefits from the operational approach are that some areas with traditional offline management are now transferred into fact-, knowledge- and risk-based adaptive management and planning. This presentation analyzes the needs and challenges for operational oceanography in seven service areas based on examples in the Baltic-North Sea: public warning service, coastal and maritime tourism, navigation, environment protection, offshore operation and energy, ecosystem-based management and climate change adaptation.

Keywords: operational oceanography, marine service area, Baltic-North Sea

1. Introduction

Together with R&D and operational products, marine information service is one of the three major pillars in operational oceanography. An “operational service” means that the service is provided regularly, in many cases in near real time but can also be in seasons or years. In the marine sector, such operational services are based on operational observations, models and data assimilation. Observations can not only be used to quantify the ocean status but also help us to understand the ocean processes and to improve the models. With operational forcing data and initial condition available, the models can provide spatiotemporal coherent and predictive fields. Via data assimilation, the models and observations are integrated so that spatiotemporal gapped observations are harmonized into non-gapped fields and the quality of the initial field and models are improved.

In Europe, the operational marine information service is mainly provided by the operational oceanography community in national, regional and European levels. Before 1980s, the operational oceanography mainly attributed to ocean monitoring. The European numerical marine forecasting started in 1980s after numerical weather prediction became available, especially the establishment of HIRLAM cooperation in 1985 for the development of high resolution regional weather model. Operational storm surge models (e.g., Dutch Continental Shelf Model – DCSM, Verlaan et al. 2005) and wave models (WAMDI Group, 1988) were developed, calibrated and operationalized in 1980s. Satellite altimeters also started operation in 1980s. In Europe, the three dimensional hydrodynamic model, e.g. BSHmod (Kleine, 1994), were used to provide ocean-ice predictions in early 1990s. With the auspicious establishment of Global Ocean Observing System (GOOS) in 1991, the European GOOS (EuroGOOS) was established in 1994 to stimulate cooperation in European operational oceanography community. At the same time, the increasing operational oceanography activities in national level raised common interests on sharing data, models and knowledge in regional level, leading to establishments of EuroGOOS regional Task Teams in late 1990s which were further developed into Regional Operational Oceanography Systems (ROOSs) in the Baltic, Northwest Shelf and Mediterranean etc. The regional cooperation and integration of operational oceanography in Europe has been powered by European Commission through the Operational Oceanography Cluster and GMES (Global Monitoring of Environment and Security) programs during FP5-FP7 period (2002-2015). An integrated European capacity on operational monitoring and forecasting in global and European seas is now operated under the auspices of EC’s Copernicus Marine Environment Monitoring Service (CMEMS). The service provides basin-scale physical-biogeochemical forecasts and reanalysis in global and European seas operationally in eddy-resolving resolutions, free of charge. At the same time, by using the basin-scale products, national efforts have been made in producing end-user products with higher resolution and added-values.

With the combination of the freely available basin-scale operational products in the core service and national value-added products in the downstream service, the marine

information service in Europe has been largely boosted for social benefit areas in blue growth, ecosystem-based management and climate change adaptation and mitigation, e.g., public service (storm surge, coastal flooding, ice service), coastal tourism, shipping, offshore energy, marine spatial planning, water quality management, marine pollution protection, coastal planning, implementation of European marine policies etc. The operational oceanography in Europe has formed a value chain of user needs, R&D, operational production and service (She *et al.*, 2016).

The development of the monitoring, modelling and service capacity of European operational oceanography in the past decade shows a very dynamic feature. The fast evolving capacities also generate new users and markets. In some social benefit areas, traditional management is based on offline decision-making. Benefited from the operational use of new infrastructures (e.g., super-computing, mobile terminals, cost-effective monitoring technology and on-line data management etc.) and data production, they are now moving to fact- and knowledge-based adaptive management. However, the new service areas are growing and far from mature. It is important to identify needs for research and development of new operational products in the existing and emerging service areas in order to meet the challenges raised in the social-benefit areas. The purpose of this paper is, using Baltic-North Sea as an example, to summarize major service areas in related to operational oceanography, analyze the user needs on operational products and research challenges required.

2. Analysis on marine service area in the Baltic-North Sea

A summary of operational oceanography service areas, products and R&D challenges is given in Tab. I. It should be known that the product specifications and challenges are indicative and nonexclusive.

Public warning service: examples are forecast and warning of water level and its extremes, coastal flooding and severe ice conditions, which need very high resolution (up to tens of meters) forecasts for land, water and estuary in the coastal zone. These are, in many cases, major responsibilities of national operational agencies. Although storm surge warning and ice service have been successfully provided in the Baltic-North Sea, improvements on coastal zone monitoring (vegetation, topography and shoreline) and coupled hydrodynamic-ice-wave-inundation models are needed for coastal flooding forecast; the quality of the ice forecast based on models should also be improved. Increasing needs on risk management for coastal disasters highlight the importance of probability forecast. Sea level assimilation should be further developed to improve the storm surge forecast. A few on-going researches are worthwhile to mention, e.g., using elasto-brittle rheology for operational ice modelling (Dansereau *et al.*, 2015), coupled storm surge – inundation modelling for coastal flooding in Copenhagen (Madsen 2017, personal communication), multi-model ensemble (MME) forecast in the Baltic-North Sea (Golbeck *et al.*, 2015), assimilation of blended altimetry and tidal gauge sea level in a storm surge model (Madsen *et al.*, 2015) etc.

Coastal and maritime tourism service: in Europe, the coastal and maritime tourism sector employs over 3.2 million people and generates a total of € 183 billion in gross value added and representing over one third of the maritime economy¹. As part of EU's Blue Growth strategy, the coastal and maritime tourism sector has been identified as an area with special potential to foster a smart, sustainable and inclusive Europe. The information service for this sector includes personalized service on high resolution forecast of meteo-ocean conditions and water quality, and also warning on bad weather, high tides, high sea state and water quality etc. More than dozens' of weather apps have been developed for tourist planning and real-time uses (Surf weather, yachting weather, beach weather, bicycle/motorcycle/car weather). However, there exists large space in product improvement, e.g., in resolution, in dynamic warning and in using remote sensing, in situ data and model forecast especially for coastal waters. More and more use of mobile terminal with Global Positioning System (GPS), radars and weather-ocean-wave-water quality models in 102-3m horizontal resolution has made it possible to provide a real-time, personalized coastal tourism information service. Further development is needed in forecasting waves in limited fetch, water quality forecast by coupling weather-hydro-logical-hydrodynamic-water quality models, assimilating chl-a data from satellites.

¹ https://ec.europa.eu/maritimeaffairs/policy/coastal_tourism_en

Table I. A summary of service areas, products and R&D challenges in operational oceanography.

SERVICE		PRODUCTS			MAJOR R&D CHALLENGES
FIELDS	TASKS	KEY PARAMETERS	HORIZONTAL RESOLUTION	PRODUCT TYPES	
Public warning service	Storm surge	Winds, Sea level	~10 ¹⁻² m	Forecast & observations	Ocean-wave-ice coupling; Water level & ice DA; Ensemble prediction; Ocean-wave-inundation coupling; Advanced ice dynamics
	Coastal flooding	Sea level, waves, shoreline, inundation	~10 ¹⁻² m		
	Navigation warning	Winds, waves, sea level, ice	~10 ¹⁻³ m		
	Ice service	Ice	~10 ²⁻³ m		
Coastal and maritime tourism	Tourist environment forecast	Meteo-ocean, ice, water quality	~10 ² m	Forecast & observations	Modelling with flexible grids; WQ monitoring
Maritime safety	Ship routine service	Meteo-ocean, ice bathymetry	~10 ²⁻³ m	Forecast & observations	Ensemble prediction; Ice forecast; HR bathymetry
	Shallow water navigation safety service		~10 ¹⁻² m		
	Search & rescue		~10 ² m		
	Maritime security		~10 ²⁻³ m		
Environment protection	Pollution, Oil spill combatting	Meteo-ocean, ice, oil drift, plastics shoreline, bathymetry, sediment	~10 ² m	Forecast & observations	HR bathymetry; Portable HR forcing; Monitoring/forecasting sediment & pollutants; Morphological models with medium complexity Submesoscale modelling
	Coastal protection		~10 ² m	Reanalysis & observations	
Offshore operation	Offshore construction	Meteo-ocean, ice	~10 ¹⁻² m	Forecast, reanalysis & observations	Ensemble prediction; High quality winds at hub-height; Air-sea PBL modelling Deep sea currents; Bottom sediment transport
	OWF siting	Meteo-ocean, ice	~10 ¹⁻² m		
	OWF power forecast	Hub-height winds	~10 ² m		
	Offshore oil & gas	Meteo-ocean, ice, sediment	~10 ²⁻³ m		
Ecosystem-based management	Environment assessment	Physical-BGC	~10 ²⁻³ m	Observations	NRT delivery of environmental data; REA with assimilation Downscaled BGC model Submesoscale modelling
	Environment assessment	Physical-BGC-high trophic level	~10 ²⁻⁵ m	Reanalysis; Forecast; Projections;	
Climate change adaptation and mitigation	Coastal WQ management	Physical-BGC	~10 ¹⁻² m	Rapid Env. Assessment;	Improved modelling of water-nutrient exchange of inter-/intra-basins and coastal-estuary; HR coupled models; Data -model integration; E2E modelling; WQ, HAB, hypoxia & fishery forecast
	Marine spatial planning	Physical-BGC, social economy	~10 ²⁻³ m	Ocean State Report;	
	Nutrient load management	Physical-BGC, social economy	~10 ¹⁻³ m	Ecosystem State Report	
	Coastal planning	Meteo-ocean-ice	~10 ⁰⁻³ m		

* BGC: biogeochemical; DA: data assimilation; HAB: harmful algae bloom; HR: high resolution; NRT: near real time; OWF: offshore wind farm; REA: rapid environment assessment; WQ: water quality

Navigation information service: moving operations in the sea such as, shipping, fishery, sailing, search and rescue and maritime security all need meteo-ocean forecast to ensure their safety and efficiency. The navigation information service has a long history, both for the private and public sectors. Recently finished and on-going EU projects, e.g. MONALISA 2, EfficienSea 2, EUCISE2020 etc. are implementing framework for e-navigation and EU network of information sharing for maritime security. The navigation will be guided with integrated information of all vessels, weather and ocean environment conditions. Accurate environment prediction is still the basis for the service. More research is needed on developing cost-efficient on-board communication technology, dynamic information system, ensemble forecasts and high quality ice and fog forecasts etc.

Environment protection: examples are marine pollution protection and coastal protection. Plastic pollution in recent years has become severe in the Baltic-North Sea. However, there still lack of efficient tools to monitor, forecast, clean and assess the impact of the plastic pollutants, both macro- and micro-plastics. A series of regional and EU projects, e.g. MARLIN (Baltic Marine Litter), CLEANSEA (Towards a Clean, Litter-Free European Marine Environment through Scientific Evidence, Innovative Tools and Good Governance) and CLAIM (Cleaning marine Litter by developing and Applying Innovative Methods) etc., have initiated the research for plastic litter. From the operational oceanography point of view, monitoring and forecasting of floating plastics can provide necessary information for making an efficient cleaning plan. Major research challenges in this area are to monitor the current distribution of the pollutants and accurately model the momentum transfer between atmosphere, ocean and waves as well as small scale motions e.g. submesoscale eddies. Another important issue is the coastal protection – to reduce the risks of coastal hazards, coastal erosion, saline water intrusion and land subsidence etc. through coastal engineering and management, e.g., building dams. The severity of the coastal erosion depends on both forcing factors (natural variability, climate change and human activities) and internal properties of the coast, e.g. its types. Sand beaches are heavily affected by the extreme events while sand marsh is more sensitive to mean climate conditions. By resolving coastal morphology (sediment transport, shoreline evolution) in operational oceanography it can provide a solid basis to support adaptive and integrated coastal zone management. Regular and rapid coastal state assessment can then be made. The research challenge is to develop operational morphology models with intermediate complexity and integrate the model and remote sensing products of suspended particle matter (SPM) and shoreline. More details regarding to coastal protection can be found in white paper on “Monitoring the evolution of coastal zones under various forcing factors using space-based observing systems”².

Offshore operations and ocean energy: the purpose of information service for offshore operations is similar to the navigation service, i.e., to ensure the safety and

² http://www.issibern.ch/forum/costzoneevo/wp-content/uploads/2016/11/ISSI-forum_Coastal_White-paper_18nov2016_Final.pdf

enhance the efficiency during the operations. Therefore most of the required data and information products are also similar, e.g., forecast of meteo-ocean conditions. The offshore operations, such as maintenance and operation of offshore wind farms and oil & gas platforms, management of out-phased offshore platforms and other offshore engineering activities, also need high resolution and localized service. The integration of meteo-ocean data and real-time observations measured at the offshore operation sites can greatly improve the service quality. For offshore energy production, some value-added add forecast e.g., power forecast are also essential. The provision of high resolution meteo-ocean products for offshore operations and ocean energy may be unified for each sea basin. The idea of a more integrated service can be found in a White Paper on Copernicus Coastal Service, suggestions based on a series of EU H2020 projects for Copernicus service evolution³.

Ecosystem-based management and climate change adaptation and mitigation:

ecosystem-based management is the basis of European marine policy implementation, e.g., Marine Strategy Framework Directive, Water Framework Directive, Common Fishery Policy, Marine Spatial Planning, Habitat Directive etc. The information service in this sector deals with a large set of physical, environmental, biological as well as social-economic variables. Since the evolution of marine ecosystem is the result of dynamic nonlinear system forced by external pressures such as natural, climate change and human activities (nutrient load discharge, fishing and other many other operations), the time scale of important processes ranging from hours to hundreds of years. The operational products useful for the ecosystem-based management covers physical and biogeochemical forecast in a few days, reanalysis in tens of years and projections for future scenarios up to hundreds of years. Currently the biogeochemical forecast is provided for time range of a few days. Major interests of users in this range is the HAB, hypoxia in shallow waters and nutrient transports caused by inflow and small scale events, e.g., fronts, upwelling and eddies. Unfortunately the model's capacity in forecasting these processes is still very much limited. The long-term products are mainly hindcast and reanalysis in decadal scales. These data can be used in assessment of the environment status, study of ecosystem dynamics and its interactions with external pressures. However, due to the limit of the biogeochemical modelling capacity in synoptic scales and data assimilation, the quality of the reanalysis products are also restricted. Rapid environment assessment and prediction in seasonal scales are very important and should be addressed in future studies. Research in this area has been initiated via e.g. EU project OPEC (Operational Ecology)⁴. The end-to-end modelling provides a basis for systematically managing the ecosystem problems especially on future scenario projections.

Another area related to climate change adaptation and mitigation is integrated coastal planning which needs to consider the future change of local climate, e.g., sea level rise, storm surge and coastal flooding etc. At national level, very high resolution climate

³ http://www.oss2015.eu/phocadownload/Comm/White_paper_COPERNICUS_Coastal_Service.pdf

⁴ <http://www.marineopec.eu/>

data are needed. One example is recently started Danish “Climate Atlas” program. High resolution and quality climate simulations (including ocean) are required to make common technical standard with considering the climate change impact when design coastal infrastructures.

Finally, it is recommended that the modelling capacity on HAB, hypoxia and nutrient transport should be improved. More biogeochemistry observations should be made available with shorter delivery time so that the REA can be updated in quarterly or yearly basis. Downscaled end-to-end modelling system in national waters and high resolution coastal climate atlas, including both reanalysis and projections are needed by the member states.

3. Recommendations

Based on the above review of the operational service areas in the Baltic-North Sea, it is recommended that a dedicated action plan for further developing and extending existing services should be made in the level of ROOSs (Regional Operational Oceanography Systems). Such a plan should cover potential user uptake activities from CMEMS, national services and emerging services in a variety of social-benefit areas.

References

- Dansereau, V., Weiss, J., Saramito, P., Lattes, P. and Coche, E. (2015). A Maxwell-elasto-brittle rheology for sea ice modeling. *Mercator Ocean Quarterly Newsletter - Special Issue*. #51-March 2015 - 35.
- Golbeck I., Li X., Janssen F, Brüning T., Nielsen J.W., Huess V., Söderkvist J., Büchmann B., Siiriä S-M., Vähä-Piikkiö O., ..., and Axell L. (2015). Uncertainty estimation for operational ocean forecast products—a multi-model ensemble for the North Sea and the Baltic Sea. *Ocean Dynamics*, 65 (12) 1603–1631
- Kleine E. (1994). Das operationelle Model des BSH für Nordsee und Ostsee, Konzeption und Übersicht. Technical report, Bundesamt für Seeschifffahrt und Hydrographie, Hamburg, Germany.
- Madsen, K. S., J. L. Høyer, W. Fu, and C. Donlon (2015), Blending of satellite and tide gauge sea level observations and its assimilation in a storm surge model of the North Sea and Baltic Sea, *J. Geophys. Res. Oceans*, 120, doi:10.1002/2015JC011070.
- She J., Allen I., Buch E., Crise A., Johannessen J.A., Le Traon P.-Y., Lips U., Nolan G., Pinardi N., Reißmann J.H., Siddorn J., Stanev E. and Wehde H.: Developing European operational oceanography for Blue Growth, climate change adaptation and mitigation, and ecosystem-based management. *Ocean Sci.* 07/2016; 12(4). DOI:10.5194/os-12-953-2016

Verlaan, M., Zijderveld, A., de Vries, H. and Kroos, J. (2005) Operational storm surge forecasting in the Netherlands: Developments in the last decade. *Phil. Trans. R. Soc. A*. doi: 10.1098/rsta.2005.1578363.

WAMDI Group (1988). The WAM model - A third generation ocean wave prediction model. *J. phys. Oceanogr.* 18: 1775–1810.

DEVELOPMENT OF OPERATIONAL OCEANOGRAPHY SYSTEM FOR FISHERY MANAGEMENT AND ITS APPLICATION IN THE CENTRAL NORTH PACIFIC OCEAN

T. Wakamatsu ⁽¹⁾⁽²⁾, H. Igarashi ⁽²⁾, Y. Tanaka ⁽²⁾, S. Nishikawa ⁽²⁾, S. Ishizaki ⁽²⁾ and Y. Ishikawa ⁽²⁾

⁽¹⁾ Nansen Environmental and Remote Sensing Center, Bergen, Norway. Tsuyoshi. wakamatsu@nersc.no

⁽²⁾ Japan Agency for Earth and Marine Science and Technology, Yokohama, Japan

Abstract

We developed regional ocean environment analysis system, Scalable Kit of Under-sea Information Delivery system (SKUIDs), to provide potential fishing ground information to fishing operators. The system is used for quasi-operational habitat monitoring/management and economical optimization of fishing operation at sea. Key components comprising the analysis system are a four dimensional data assimilation system, statistical analysis scheme for detecting potential fishing ground at an oceanic frontal scale and the web-based visualization system for delivering the information to fishing vessels. In this presentation, we discuss general performance of the operational system and its effectiveness over the neon flying squid (*ommatrephes bartramii*) summer fishing operation in the Central North Pacific Ocean.

Keywords: operational oceanography, data assimilation, neon flying squid, habitat suitability index (HSI), machine learning

1. Introduction

Near-real time analyses/forecasts and dissemination of marine environment variables through operational system are key factors to conduct cost effective and efficient socioeconomic activities at sea. For fishery applications, capability of producing specific information tailored to each group of fish stock is a key requirement in the operational system. To meet the key requirement, we have developed a new framework of an operational oceanographic system for marine environment analysis, Scalable Kit of Under-sea Information Delivery system (SKUIDs). Its core components are data assimilation system for integrating observation and numerically simulated

physical ocean state and an empirical mapping function of habitat suitability index (HSI) for a specific fish stock. Operational framework equipped with functions of near-real time ocean state analysis/forecast and their direct dissemination to fishery fleets is then built. The system's performance is tested in its pilot application for assisting neon flying squid (*ommastrephes bartramii*) fishing operations in the Central North Pacific Ocean (CNP) conducted during the boreal summer from May to September in 2015 and 2016.

2. Operational System

Core components of SKUIDs are a physical ocean hindcast/forecast system based on the 4DVar ocean data assimilation system, MOVE-4DVar (Usui *et al.*, 2015) and the ocean general circulation model, MRI.COM (Tsujino *et al.*, 2011). Control variables are initial values of potential temperature and salinity at the top 1500 meter. Three types of near real time observation, Argo float temperature and salinity profiles data distributed from Global Temperature and Salinity Profile Programme (<http://www.nodc.noaa.gov/GTSP/>), along track sea level anomaly (SLA) data distributed from Aviso (<http://www.aviso.altimetry.fr/duacs/>) and gridded sea surface temperature (SST) data, MGDSSST, distributed from Japan Meteorological Agency (http://ds.data.jma.go.jp/gmd/goos/data/pub/JMA-product/mgd_sst_glb_D) are assimilated. Job scheduling in the analysis system is designed as in Fig. 1. Length of hindcast (assimilation) window is set to two weeks and length of forecast window is set to three weeks. Forecast cycle submission follows completion of the analysis cycle and the next analysis cycle starts from mid-point of the previous hindcast window. The choice of staggered timing of subsequent hindcast cycles help making our analysis system operationally robust, being secured by existence of analysis products for a specific period in three folds. Total processing time of a single operational cycle, which includes analysis/forecast cycle, near real time input data acquisition and products dissemination time is about a week.

3. Fishery application

As a pilot application of SKUIDs for the fishery industry, we have set up a quasi-operational system for assisting summer operation of neon flying squid (NFS) fishing in the CNP, which is known to be one of the richest NFS fishing ground in the North Pacific Ocean. The Analysis system is implemented on the CNP (170E-150W, 30N-50N) configuration of MRI.COM (Fig. 2). The configuration has 0.1 degree horizontal grid and 54 levels vertical z-coordinate. Atmospheric forcing is created from Japan Meteorological Agency JRA55 near real time reanalysis (http://jra.kishou.go.jp/JRA-55/index_en.html) for a hindcast cycle and its climatological mean data for a forecast cycle. Design of the domain, analysis period and dissemination variables are determined after conducting surveys with NFS fishing operators based in the Aomori Prefecture of northern Japan. The dissemination variables are sea surface eddy kinetic energy, sea surface current velocity, sea surface height, sea surface temperature and habitat suitable index (HSI).

A HSI map optimized for NFS in their summer fishing ground is drawn based on an empirical function of optimized set of the marine environment (habitat) variables, sea surface temperature (SST), sea surface height (SSH), horizontal gradient of SSH, sea surface salinity (SSS), subsurface temperature (T246) and meridional current velocity (V246) at 246m depth. The empirical function was trained using machine learning method during the pilot study conducted in 2012 (see Appendix). From the pilot study (Igarashi *et al.*, 2014), it was found that the subsurface information, T246 and V246, are key habitat variables that improve prediction skill of our HSI model. These variables are related to sub-surface frontal structure in the analysis domain and it reflects the observational evidence that NFS fishery grounds tend to be formed around southerly intrusion of warm subtropical water in the depth. Mixed layer depth (MLD) does not contribute to improvement of the prediction skill due to low correlation between summer MLD and level of nutrients in the analysis domain and is excluded from the set of habitat variables.

The hindcast and forecast products created by the analysis system are delivered directly to fishing fleets by satellite network in near real time and used to detect NFS fishing grounds. A sample HSI map provided through our operational system is shown in Fig. 3. Contour lines indicate HSI from 0.5 to 0.9 and higher values indicate better environment for catching the targeted species. There is a clear front in HSI map around 40N and the high catch rate is observed along this front according to the report on the NFS catch per unit effort (CPUE) from fishery operator at site.

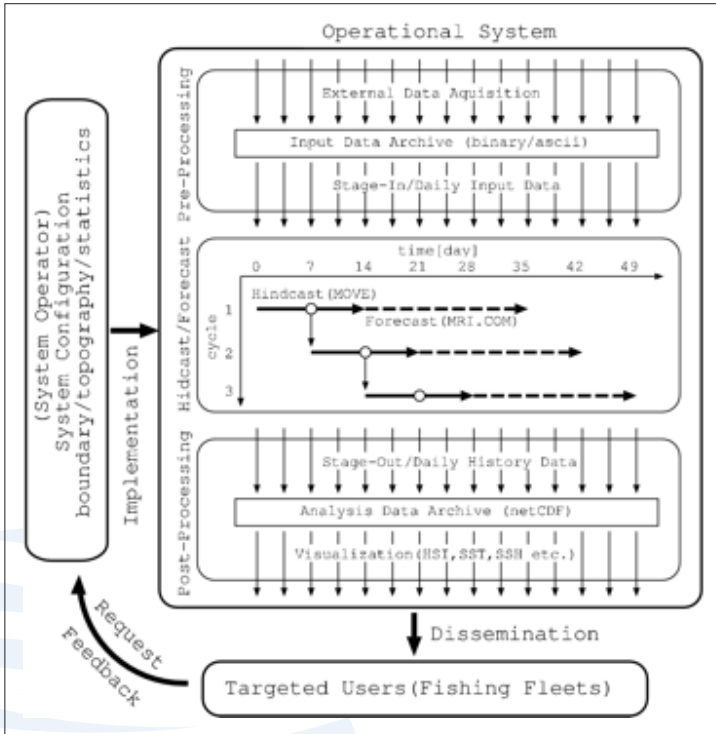

Fig. 1. Design of operational oceanography system framework, SKUIDs, for fishery applications.

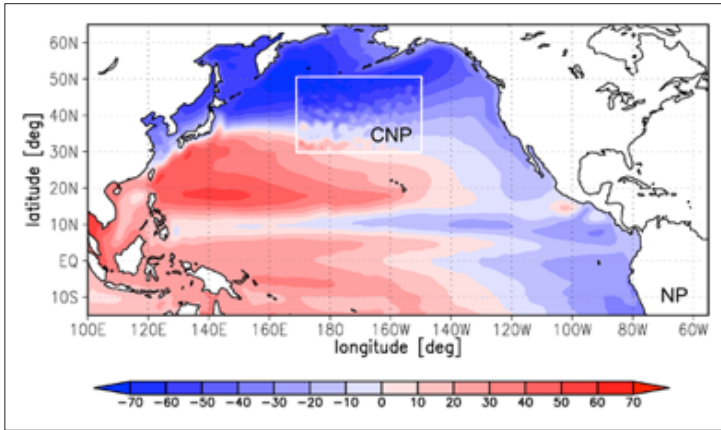

Fig. 2. Map of analysis domain: the Central North Pacific (CNP) and its parent model domain: the North Pacific (NP). Contours are sea surface height in cm with 10 cm interval from 20 years spinning-up experiments.

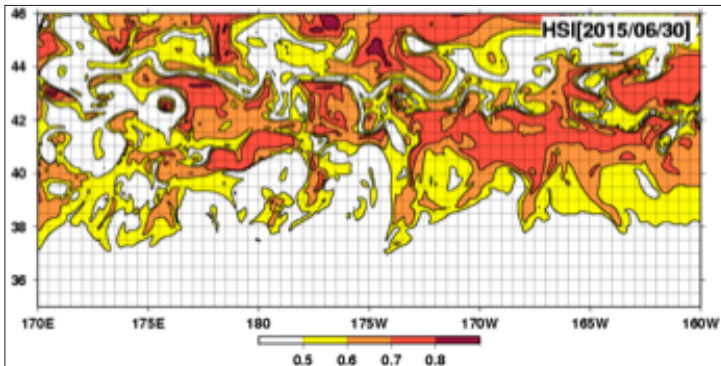

Fig. 3. (left). Map of habitat suitability index (HSI) for Neon flying squid in the central North Pacific Ocean. Contour interval is 0.1. Map is created from SKUIDs-CNP analysis on 2015 June 30th.

4. Summary and concluding remarks

Quasi-operational system of marine environment analysis/forecast and dissemination system, SKUIDs, was developed. The system was tested in the pilot study for assisting neon flying squid fishing operation in the Central North Pacific Ocean during boreal summer in 2015 and 2016. The performance of the system is promising and its application to other fish stocks and other areas of ocean are under development.

APPENDIX: HSI MODELLING

This appendix closely follows Tian *et al.*, (2009) and Igarashi *et al.*, (2014). For each habitat variable listed in section 3, the empirical function, $f_i(v_i)$, that predicts $\ln(\text{CPUE})$ from a habitat variable, v_i , was established given training data using the spline smooth regression. The training data are CPUE (as a function of location and time) provided by Aomori Prefectural Industrial Technology Research Center and MOVE ocean reanalysis data (Fujii and Kamachi, 2003) during the period from 1999 to 2008. Each empirical function is converted to the suitable index (SI) function that ranges from 0 (least suitable) to 1 (most suitable) by the following transformation:

$$\text{SI}_i(v_i) = \left(f_i(v_i) - f_i^{\min} \right) / \left(f_i^{\max} - f_i^{\min} \right), \quad (\text{a1})$$

where, $f_i^{\min(\max)}$ is the minimum (maximum) value of, $f_i(v_i)$. HSI model is then defined by geometric mean of the SI indices as

$$\text{HSI}(v_1, L, v_N) = \sqrt[N]{\prod_{i=1}^N \text{SI}_i(v_i)} \quad (\text{a2})$$

where N is the total number of habitat variables. Generally, the area with the highest range of HSI (e.g., 0.6–1.0) is designated as good habitat and correspondingly the area with the lowest HSI (e.g., 0–0.2) as poor habitat (see Fig. 3).

Acknowledgements

This work was funded by Research Program on Climate Change Adaptation (RECCA) and supported in part by Data Integration and Analysis System (DIAS) of the Ministry of Education, Culture, Sports, Science, and Technology (MEXT), Japan. MOVE-4DVar and MRI.COM are provided from Japan Meteorological Agency.

References

- Fujii Y. and M. Kamachi (2003). A reconstruction of observed profiles in the sea east of Japan using vertical coupled temperature-salinity EOF modes, *J. Oceanogr.*, 59, 173–186.
- Igarashi, H., T. Awaji1, Y. Ishikawa, M. Kamachi, N. Usui, M. Sakai, Y. Kato, S. Saitoh and M. Seito (2014). Development of a Habitat Suitability Index Model for Neon Flying Squid by Using 3-D Ocean Reanalysis Product and its Practical use –RECCA Squid Project–. *JAMSTEC Report of Research and Development*, 18: 89–101.
- Tian S., X.J. Chen, Y. Chen, L. Xu, and X. Dai (2009). Evaluating habitat suitability indices derived from CPUE and fishing effort data for *Ommastrephes bartramii* in the northwestern Pacific Ocean, *Fish. Res.*, 95, 181–188.
- Tsujino, H., M. Hirabara, H. Nakano, T. Yasuda, T. Motoi and G. Yamanaka (2011). Simulating Present Climate of the Global Ocean-Ice System Using the Meteorological Research Institute Community Ocean Model (MRI.COM): Simulation Characteristics and Variability in the Pacific Sector. *Journal of Oceanography*, 67:449–479.
- Usui, N., Y. Fujii, K. Sakamoto and M. Kamachi (2015). Development of a four-dimensional variational assimilation system for coastal data assimilation around Japan. *Mon. Wea. Rev.* 143:3874–3892.

IMPROVING THE IEO/NODC ACTIVITY BY A DISTRIBUTED AND COORDINATED INFRASTRUCTURE

E. Tel⁽¹⁾, L. Arranz⁽¹⁾, A. Cabrero⁽²⁾, I. Chamarro⁽¹⁾, G. González-Nuevo⁽²⁾, P. Otero⁽¹⁾ and A. Vilorio⁽³⁾

⁽¹⁾ Instituto Espanol de Oceanografia (IEO). Servicios Centrales. C/ Corazon de Maria, 8. 28002-Madrid (Spain). elena.tel@ieo.es

⁽²⁾ Instituto Espanol de Oceanografia (IEO). C.O. Vigo

⁽³⁾ Instituto Espanol de Oceanografia (IEO). C.O. Santander

Abstract

Since 1964, the Instituto Español de Oceanografía (IEO) runs the National Oceanographic Data Center (NODC), responsible for the compilation, storage and distribution of marine data for researching, advising and the different demands that have been evolving among the times. The integration into larger international frameworks includes the Global Ocean Observing System (GOOS) and its regional groups, International Oceanographic Data and Information Exchange (IOC/IODE), or European consortiums as SeaDataNet and EmodNET have been contributed to move forward under the guidelines of standardization for geospatial data and related information as marine research projects, vessels and observatories. Taking advantage of IEO coastal centers experience in data acquisition as well as the last software developments, the NODC has implemented a distributed infrastructure that shorts the time taken to incorporate the data and marine information from its acquisition into the permanent database. This organization includes survey acquired data, but also continuous data from research vessels, the ocean-meteorological buoy and coastal tide gauges. Metadata and data are spread to the research community and society through SeaDataNet infrastructure but also lets the IEO maintaining its own national data portal giving response to governmental and national inquiries.

Keywords: Data management, marine information, datacentre

1. Introduction

Access to marine data is vitally important for marine researchers, but also for a wide variety of professionals and general public, who use these data to face problems related to climate change, coastal engineering, fishing or aquaculture, but also recreational navigation, nautical sports, tourism, etc. Data producers interested in targeting a wider and general public, should design user-friendly sites, with the use of the proper terminology, prioritizing end-user interests and letting their applications interact with the public through social network sites. However, from an organizational point of view, achieving this goal implies to walk a long path where standardization and interoperability are main steps for managing the large and diverse data sets that are collected by the oceanographic surveys and the ocean observation systems.

In Spain, since 1964 the IEO maintains the National Oceanographic Data Center (NODC), responsible for the compilation, storage and distribution of marine data, and contributes to various international initiatives. Recently a new effort to move forward under the guidelines of standardization for geospatial data and information of projects, vessels and observatories, including the additional effort that must be done to accomplish the INSPIRE Directive (2007/2/EC) and to bring marine data closer to the Spanish end-user community. The NODC-IEO contributes actively to the institutional observing system IEOOS (Tel *et al.*, 2016).

2. Procedures

Nowadays, marine data received at the IEO Datacenter are transcript in the auto-descriptive ASCII SDN-Medatlas format (Lowry *et al.*, 2017) by using the software NEMO (Fichaut *et al.*, 2016). Data Quality Control procedures (Seadatanet consortium, 2010) are performed to detect missing information, format errors, duplicates and outliers. Following the agreed criteria, a quality flag is attached to each numerical value in order to preserve original data, provide them added-value and permit future re-validations. Each profile or dataset is accompanied of a XML-metadata file created by using MIKADO (Tosello *et al.*, 2014), which describes the dataset and is shared within the SeaDataNet infrastructure. In order to accomplish to ISO-19139 and satisfy the Spanish transposition of INSPIRE Directive requirements a transformation of these metadata are performed and the information is distributed through a customized GeoNetwork portal, focused on cataloguing IEO data (Otero *et al.*, 2016).

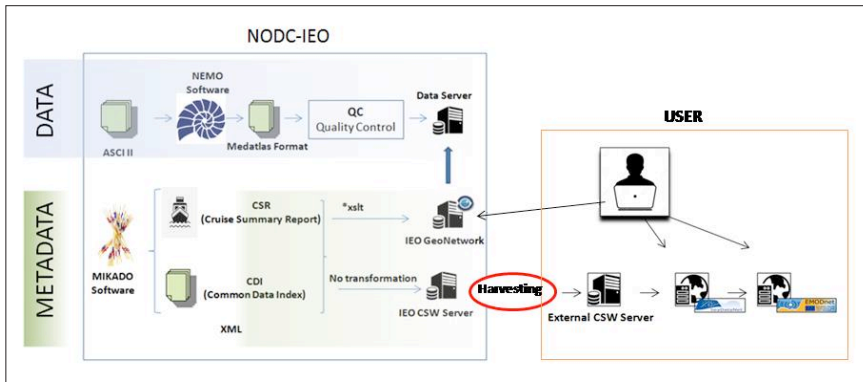

Fig. 1. Scheme of the data and metadata processing carried out by the NODC-IEO . Data to be shared with the SeaDataNet infrastructure (CTD, XBT and water samples among others) are formatted and quality-controlled before storing. The associated metadata (CDI) are: i) created using MIKADO, ii) stored in a dedicated server and iii) directly served through the SeaDataNet infrastructure via harvesting. Similar process is done to serve the information about cruises (CSR). In parallel, these metadata are transformed using XSL technology to facilitate their integration into GeoNetwork. Thus, the end-user, can explore and retrieve data through EMODNET, SeaDataNet or directly at the IEO portal.

References

- Fichaut M., Brégent S. , Dimitri C. (2016) SeaDataNet NEMO user manual. https://www.seadatanet.org/content/download/680/3582/file/sdn_Nemo_UserManual_V1.6.3.pdf?version=1
- Lowry, R. Fichaut, M, Schlitzer, R. (2017) SeaDataNet data file formats: ODV, MEDATLAS, NetCDF (deliverable D8.5) https://www.seadatanet.org/content/download/636/3333/file/SDN2_D85_WP8_-Datafile_formats.pdf?version=2.
- SEADATANET Consortium (2010) Data Quality Control Procedures Version 2.0 May 2010 https://www.seadatanet.org/content/download/596/3118/file/SeaDataNet_QC_procedures_V2_%28May_2010%29.pdf?version=1
- Otero, P., Tel, E., González-Nuevo, G. (2016) IEO marine data discovery, representation and retrieval through metadata interoperability. Bollettino di Geofisica teorica ed applicata, Proceedings of IMDIS 2016 Conference. 57supplement.130-131 2016 (ISSN 0006-6729)
- Tel, E., Balbin, R., Cabanas, J.-M., Garcia, M.-J., Garcia-Martinez, M. C., Gonzalez-Pola, C., Lavin, A., Lopez-Jurado, J.-L., Rodriguez, C., Ruiz-Villarreal, M., Sánchez-Leal, R. F., Vargas-Yáñez, M., and Vélez-Belchí, P. (2016) IEOOS: the Spanish Institute of Oceanography Observing System. Ocean Science, 12, 345-353, <https://doi.org/10.5194/os-12-345-2016>, 2016.

Tosello V., Fichaut M., Larour M., Pertuisot C. (2014) MIKADO: user manual Version 3.3.4.
https://www.seadatanet.org/content/download/651/3414/file/sdn_Mikado_UserManual_V3.3.4.pdf?version=1



THE DATA LIFECYCLE AT SOCIB: RESPONDING TO SCIENTIFIC AND SOCIETAL NEEDS

C. Muñoz ⁽¹⁾, C. Troupin ⁽²⁾, J. G. Fernández ⁽¹⁾, B. Frontera ⁽¹⁾, P. Rotllán ⁽¹⁾, I. Ruíz ⁽¹⁾, M. Gomila ⁽¹⁾, S. Gómara ⁽¹⁾, F. Notario ⁽¹⁾, M. Charcos ⁽¹⁾, D. March ⁽¹⁾, B. Casas ⁽³⁾, E. Heslop ⁽¹⁾, D. Álvarez ⁽¹⁾, L. Gómez-Pujol ⁽¹⁾, M. À. Rújula ⁽¹⁾ and J. Tintoré ^(1,3)

⁽¹⁾ SOCIB, Palma, Spain

⁽²⁾ Geohydrodynamics and environment research, ULg, Liège, Belgium

⁽³⁾ IMEDEA (CSIC-UIB), Esporles, Spain

Abstract

The Balearic Islands Coastal Ocean Observing and Forecasting System, is a Marine Research Infrastructure (ICTS) that provides world-class, quality controlled metocean data, in both real time and delayed mode, from across its multi-platform coastal to open ocean observing and forecasting system. This multi-platform approach is needed to properly capture oceanographic processes, that take place at different spatial and temporal scales, and that characterise both ocean state and ocean variability.

The observing system provides physical and biogeochemical variables from different platforms like research vessel, high-frequency (HF) radar system, weather stations, tide gauges, moorings, drifting buoys, ARGO profilers, gliders and sensors attached to sea turtles. The forecasting system uses high-resolution numerical models for hydrodynamics and waves.

SOCIB Data Centre is responsible for the different stages of data management, covering the whole data life-cycle, ranging from data acquisition using observational platforms, numerical models or information generated by other divisions, to distribution and visualization through the development of specific tools for visualising the data sets, including both dedicated web and mobile applications. The implemented system relies on open source solutions and facilitates the transfer of data from SOCIB to other international portals, such as EMODnet-Physics, CMEMS INSTAC or MONGOOS.

Data services and applications were developed in line with EU-funded initiatives as CMEMS, Jerico-Next, ODIP2 to provide response to scientific and societal needs, by targeting user profiles such as researchers, technicians, policy and decision makers, educators, students and society in general.

Other applications are being developed as an adaptation to different sectors within SOCIB's new Products and Services 2017 strategy (coast guard and Bluefin tuna apps).

SOCIB organizational and conceptual structure as a facility of facilities is a good example of Marine Information System within the framework of new Ocean Observatories and/or Marine Research Infrastructures, a system that, through open data principles, generates added value to both cover the scientific community demands and respond to general society needs.

Keywords: operational oceanography, multi-platform, open data, data management, NetCDF

1. The SOCIB-ICTS Marine Research Infrastructure

The Balearic Islands Coastal Observing and Forecasting System, SOCIB (Tintoré *et al.*, 2013), is a multi-platform Marine Research Infrastructure that provides free, open, standardized and quality-controlled data from near-shore to the open sea, responding to a change of paradigm in the observation of our oceans and coasts, an observation that has evolved from being centered on a unique platform, the oceanographic ships with data availability being delayed in time, to an observation now based on multi-platform and integrated systems. In our case, this involves a coastal research vessel, a high-frequency (HF) radar system, weather stations, tide gauges, moorings, drifting buoys, ARGO profilers, and gliders (autonomous underwater vehicles). Recently the system has begun incorporating oceanographic sensors attached to sea turtles, providing trajectories given by the animals. High-resolution numerical models provide forecast for hydrodynamics (ROMS) and waves (SAPO).

This change of paradigm is very significant and allows being able to respond to the three key drivers identified by SOCIB back in 2009: (1) science priorities, (2) technology development, (3) response capacity to society needs.

2. The role of the Data Centre

The SOCIB Data Centre Facility (DCF) is responsible for the different stages of data management and covers the whole data life-cycle, ranging from data acquisition using SOCIB observational platforms (gliders, drifters, HF radar, ...), numerical models (hydrodynamics, waves, rissaga...) or information generated by other divisions, to distribution and visualization through the development of specific tools for visualizing the data sets, including both dedicated web and mobile applications. The implemented system relies on open source solutions.

In order to cope with a wide range of platforms, automatic management and processing, are necessary. Here we present some of the applications developed to perform the oceanographic data management of the different platforms and a specific example developed for gliders.

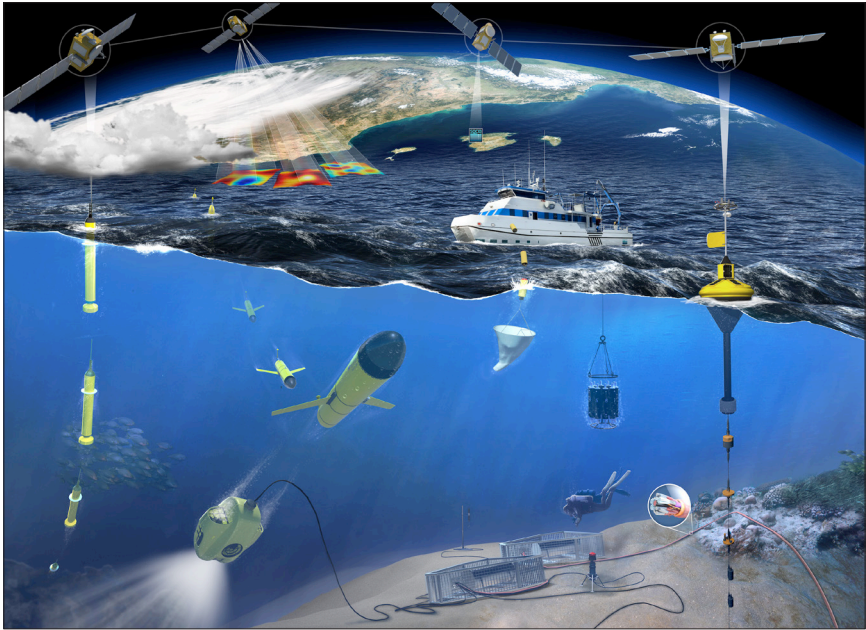

Fig. 1. SOCIB multi-platform observing system.

- **Instrumentation:** a database that contains the inventory of materials, the activities performed with them and the processing applied on the collected datasets;
- **Processing:** an application designed to extract meta-data of the deployed equipment from Instrumentation and to perform the data ingestion, processing, quality control and standardization;
- **Glider toolbox:** (https://github.com/socib/glider_toolbox): a complete set of MATLAB/Octave scripts that automates glider data processing function, including thermal lag correction, quality control and graphical outputs (Troupin et al., 2016).

3. Products and services

SOCIB data services and applications have been developed in line with EU-funded initiatives such as Copernicus Marine Environment Monitoring Service, Jerico-Next, ODIP2, and MedSea Checkpoint (among others), to provide response to scientific and societal needs, by targeting different user profiles such as researchers, technicians, policy and decision makers, educators, students, and society in general, and also providing applications to:

- Allow researchers and technicians to access oceanographic information;
- Provide decision support for oil spills response at sea and at the coast;
- Disseminate information about the coastal state for tourists and recreational users;
- Present coastal research in educational programs;
- Offer easy and fast access to marine information through mobile devices.

A set of tools is currently available to visualize and explore the data without having to download them.

In addition, the Data Centre has recently implemented a new API that aims to replace its former REST web service, Data Discovery, and to make the development of applications by external users easier. This new service allows data generated by SOCIB to be integrated into applications developed by the Data Centre itself, including SOCIB Data Catalog, and also facilitates the transfer of data from SOCIB to other international portals, such as EMODnet-Physics, CMEMS INSTAC or MONGOOS.

4. Applications

The general objective is to allow the scientific and the general public to visualize and explore the data without having to download them, through a set of tools, among which:

- DAPP Deployments application (<http://apps.socib.es/dap>), a web application to display information related to mobile platform trajectories;
- LW4NC2 (<http://t2hredds.socib.es/lw4nc>), a web application for multidimensional (grid) data from netCDF files (numerical models, HF radar);
- LEAFLET TIMEDIMENSION (<https://github.com/socib/Leaflet.TimeDimension>): a free, open-source Leaflet.js plugin that enables visualization of spatial data with a temporal dimension.

Based on the available data and using a set of web services, several applications were built:

- SEABOARD (<http://seaboard.socib.es>), a dashboard combining different sources of information in real time for different types of users;
- Smart-phone apps to access data, platform trajectories and forecasts in real-time;
- “Medcllic: the Mediterranean in one click” (<http://www.medcllic.es/en/>), a web dedicated to the Mediterranean Sea monitoring, with scientific and an outreach component. The program “Medcllic” encompasses a research project and a scientific dissemination project, both of which are related to the scientific, technological and dissemination approaches of SOCIB, aimed at research excellence and the development of technology which enables progress toward the sustainable management of coastal and marine environments, providing solutions to meet the needs of society.

5. Conclusions

SOCIB organizational and conceptual structure as a facility of facilities is a good example of Marine Information System within the framework of new Ocean Observatories and/or Marine Research Infrastructures, a system that, through FAIR opendata principles, generates added value to both cover the scientific community demands and responds to general societal needs.

Acknowledgements

The SOCIB Data Center tools development benefited from EU-funded projects, The Balearic Government, and the Spanish National Plan for research.

References

- C. Troupin, J.P. Beltran, E. Heslop, M. Torner, B. Garau, J. Allen, S. Ruiz, J. Tintoré, 2016. A toolbox for glider data processing and management. *Methods in Oceanography*, Vol. 13-14, Pag. 13-23. doi:10.1016/j.mio.2016.01.001
- Tintoré J, Vizoso G, Casas B, Heslop E, Pascual A, Orfila A, Ruiz S, Martínez-Ledesma M, Torner M, Cusí S, Diedrich A, Balaguer P, Gómez-Pujol L, Álvarez-Ellacuría A, Gómara S, Sebastian K, Lora S, Beltrán JP, Renault L, Juzà M, Álvarez, D, March D, Garau B, Castilla C, Cañellas T, Roque D, Lizarán I, Pitarch S, Carrasco, MA, Lana A, Mason E, Escudier R, Conti D, Sayol J M, Barceló B, Alemany F, Reglero P, Massutin E, Velez-Belchí P, Ruiz J, Gómez M, Álvarez A, Ansorena L, Manríquez M (2013) SOCIB: the Balearic Islands Observing and Forecasting System responding to science, technology and society needs, *Mar Tech Soc J*, 47:101–117. doi:10.4031/MTSJ.47.1.10.

GEO-SCIENTIFIC PLATFORM AS A SERVICE: TOOLS AND SOLUTIONS FOR EFFICIENT ACCESS TO AND ANALYSIS OF OCEANOGRAPHIC DATA

M. Wergeland Hansen, A. Korosov and A. Vines

Nansen Environmental and Remote Sensing Center, Thormøhlens gate 47, NO-5006 Bergen Norway

Abstract

Existing international and Norwegian infrastructure projects, e.g., the European Space Agency (ESA) GlobCurrent, and the Research Council of Norway (RCN) NorDataNet, NMDC and NORMAP projects, provide open data access through the OPeNDAP protocol following the conventions for CF (Climate and Forecast) metadata, designed to promote the processing and sharing of files created with the NetCDF application programming interface (API). This approach is now also being implemented in the Norwegian Sentinel Data Hub (satellittdata.no) to provide satellite EO data to the user community. Simultaneously with providing simplified and unified data access, these projects also seek to establish and use common standards for use and discovery metadata allowing development of standardized tools for data search and (subset) web streaming to perform actual scientific analysis.

We introduce a concept that we call a Geo-Scientific Platform-as-a-Service (Geo-SPaaS) to aid the management and synergistic use of EO data focused on oceanographic applications. Geo-SPaaS handles data from satellite remote sensing but also in situ and model data. It can be understood as a system providing the integration of scientific tools, algorithms, and georeferenced data stored at various locations. Geo-SPaaS allows users to work on their local desktops, using local CPU with integration to cloud systems to analyze their data. In this manner, the Geo-SPaaS helps users to focus on the scientific research without bothering where the data is stored or its format, nor the maintenance of the infrastructure or the software.

The Geo-SPaaS components are integrated in virtual machines (VMs; e.g., VirtualBox, VMware), of which provisioning and deployment are automatized using existing state-of-the-art open-source tools (e.g., Vagrant, Ansible, Git, Python). The open-source code for scientific tools and virtual machine configurations is available on GitHub (<https://github.com/nansencenter/>), and is coupled to an on-line continuous integration system (Travis CI). By the use of common VM configurations under git version control, the tools allow simplified and improved workflow management and team collaboration.

Keywords: remote sensing, workflow management, oceanography

1. Logical design

The Geo-SPaaS concept is inspired by standard cloud computing service models, i.e., Infrastructure as a Service (IaaS), Platform as a Service (PaaS), and Software as a Service (SaaS) [1]. These models typically serve to improve software development speed, allowing the user to focus on the application itself, and to reduce costs by outsourcing hardware and software maintenance to the service provider [2]. As such, Geo-SPaaS shall help reduce the time and effort that scientists have to spend searching for data, and to develop their own tools for processing and analysis.

The Geo-SPaaS is structured as illustrated in Fig. 1. It integrates existing tools and data repositories into a distributed system, by providing the necessary “glue” to make them inter-operable and inter-connected. The software layers supporting this interoperability are implemented as modular open source components, allowing the whole system to be open, extensible and scalable. The design objectives will be accomplished by integrating already developed tools with an application program interface (API) to allow easy access to the data in a single platform. The user experience, i.e., in employing the interactive tools for efficient prototyping, testing and operationalization of multi-sensor synergistic algorithms, is thus of major importance.

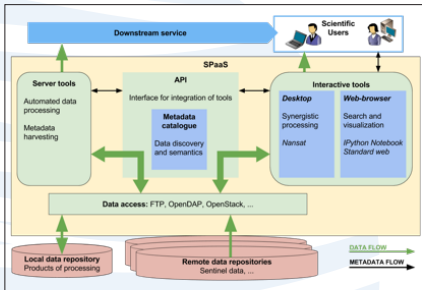

Fig. 1. Technical structure and main data and information flow in the proposed Scientific Platform as a Service (SPaaS).

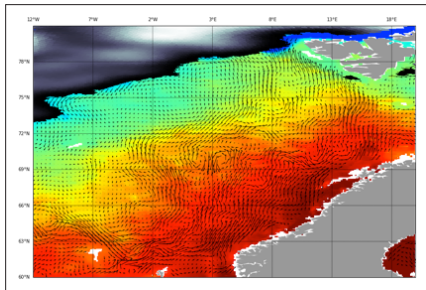

Fig. 2. An example illustration of collocated sea surface temperature, sea ice concentration, sea surface geostrophic current on 1 July 2013 from NORMAP.

2. Example use cases

2.1 Installation and synchronization of common programming environment

In order to start using Geo-SPaaS or any of its components a user needs to install three open source cross-platform packages available for Windows, Mac and Linux: GIT, Vagrant, and VirtualBox. These packages are available for free and their installation is system specific. After this step a user needs to open a terminal window and type two commands:

```
# Get VM configurations
git clone https://github.com/nansencenter/nersc-vagrant.git
# Start course VM
vagrant up <vm-name>
```

This will download and install a minimal version of Linux Ubuntu 14.04 in a virtual machine, provision it with all required third party libraries, and install the Nansat and Django-Geo-SPaaS software. In order to update the code or any components of the programming environment a user needs to run the following commands:

```
# Update VM configurations
git pull
# Update course VM
vagrant provision <vm-name>
```

2.2 Search and collocate datasets

For batch processing of many satellite images or for searching collocated datasets, a user needs to first add metadata to the Geo-SPaaS catalog using the following command:

```
# Ingest dataset metadata to catalog
python manage.py ingest <path>
```

Next, after opening the IPython terminal the following commands can be used:

```
# Fetch all datasets from the database
allDs = Dataset.objects.all()

# Fetch only MODIS images
modisDs = Dataset.objects.filter( source instrument short_name = 'MODIS')

# Fetch ASAR images overlapping with
# the first MODIS image
asarDatasets = Dataset.objects.filter(source instrument short_name=ASAR').
filter(datalocation geometry intersects= modisDs[0].datalocation geometry)
```

When one or more datasets are discovered, they can be opened with Nansat (or other software installed on the VM) for intercomparison, visualization, and further analysis. An example image containing collocated sea surface temperature (SST), ice concentration, and sea surface geostrophic served via OpenDAP in the NORMAP project is shown in Fig. 2. The code for creating this image with Nansat, together with many other examples, is provided in the Nansat lecture notes (<https://github.com/nanscenter/nansat-lectures>).

References

- [1] Q. Zhang, L. Cheng, and R. Boutaba, "Cloud computing: state-of-the-art and research challenges," *Journal of internet services and applications*, 2010.
- [2] National Institute of Standards and Technologies, "The NIST Definition of Cloud Computing," Tech. Rep., National Institute of Standards and Technologies, 2011.
- [3] Peter Cornillon, James Gallagher, and Tom Sgorous, "OPeNDAP: Access data in a distributed, heterogeneous environment," *Data Science Journal*, 2003.



DATA SHARING TOOLS FOR THE SOUTHERN OCEAN OBSERVING SYSTEM

P. Bricher⁽¹⁾, S. Diggs⁽²⁾, J. Beja⁽³⁾ and B. Pfeil⁽⁴⁾

⁽¹⁾ Southern Ocean Observing System, University of Tasmania, Private Bag 110, Salamanca 7004, Australia, data@soos.aq.

⁽²⁾ Carbon and CLIVAR Hydrographic Data Office, Scripps Institution of Oceanography, University of California San Diego, USA

⁽³⁾ British Oceanographic Data Office, Liverpool, UK

⁽⁴⁾ Bjerknes Climate Data Centre, University of Bergen, Bergen, Norway

Abstract

The Southern Ocean Observing System (SOOS) faces many of the same data challenges as observing systems in other parts of the globe. To better understand the processes at play in the Southern Ocean, we need to collate datasets from various scientific disciplines that are currently scattered across the world's data repositories. In addition, the size and remoteness of the Southern Ocean means that international cooperation in collecting observations is particularly important. At SOOS, we are developing a number of data sharing projects to bridge the gaps between these repositories.

In this poster, we will share our experiences in developing DueSouth: A Database of Upcoming Expeditions to the Southern Ocean - a publicly editable spatial database of voyage and project plans. We will also present SOOSmap, which gives a snapshot of the status of observing platforms in the Southern Ocean at any given time. Finally, we will discuss plans to federate searching for individual datasets across the world's data repositories. These SOOS data initiatives may be of interest to our colleagues facing similar challenges in European oceans.

Keywords: data discovery, field planning, oceanography, federated search, map

1. Introduction

The Southern Ocean plays a crucial role in global climate, ecological, and biogeochemical cycles because of its role connecting the world's ocean basins. Observations to date suggest that the Southern Ocean is changing, but the cost and logistical challenge of doing science in the Southern Ocean, particularly during the Austral winter means that the region is chronically under-sampled (Meredith *et al.*, 2013). Adding to the challenge, it is often difficult to find datasets that have already been collected in the various scientific disciplines relevant for SOOS. The difficulty in finding data stems from two key causes. Firstly many datasets are simply never submitted to a publicly-accessible data centre, often despite International, national, or institutional policies requiring the publication of data. Secondly, even when best practice data management occurs, the sheer number of data centres holding Southern Ocean data means it is difficult for a scientist to know where they should look for a specific dataset. This poster deals specifically with the second of these issues.

In many ways, the number of data centres is a good problem to have; certainly it is better than the alternative of an insufficiency of but it makes data discovery more challenging. National or domain-specific data centres typically employ staff with expertise that allows them to give practical advice to data owners on the best way to manage and share data within their discipline.

Increasingly, over the past two decades, data managers have focussed on improving interoperability of their storage systems, metadata standards, and data formats. In particular, some disciplines have developed, and others are initiating the development, of Global Data Assembly Centres that focus on aggregating and quality-assuring specific kinds of data. This improving interoperability allows groups like the Southern Ocean Observing System (SOOS) to develop tools that ease the discovery of datasets across multiple disciplines and nations.

2. SOOS and Southern Ocean Data

Southern Ocean data poses particular challenges for data discovery. The Southern Ocean Observing System (SOOS) is an international initiative that facilitates the collection and delivery of essential observations on dynamics and change of Southern Ocean systems to all international stakeholders (researchers, governments, industries), through design, advocacy and implementation of cost-effective observing and data delivery systems. SOOS is an international initiative of the Scientific Committee on Antarctic Research (SCAR) and the Scientific Committee on Oceanic Research (SCOR).

As part of SOOS' mission, we are developing a series of data discovery and sharing tools to enable greater collaboration and easier data discovery for Southern Ocean researchers.

2.1 DueSouth

DueSouth, a Database of Upcoming Expeditions to the Southern Ocean, is a crowd-sourced database of field plans, including details of planned voyages and the projects

associated with them. Through DueSouth, researchers can find other researchers collecting similar data before they start fieldwork.

DueSouth was developed for SOOS by the Australian Antarctic Data Centre and can be found on the SOOS homepage <http://www.soos.aq>.

2.2 SOOSmap

SOOSmap is a map of the state of the observing system through time, showing the distribution of observing platforms. Additionally, it functions as a data portal, giving access to well-curated circumpolar datasets. For many data types, the datasets are available for download through SOOSmap itself. For others, SOOSmap provides a link to the originating data centre. The initial construction of SOOSmap by the developers at the EU-funded EMODnet-Physics is complete, but new layers will be added in coming months. SOOS and EMODnet are working together to identify key datasets that should be brought into their data sharing infrastructure.

The long-term vision of SOOS calls for a cyber-infrastructure that brings together the core Southern Ocean observing data so that it can be fed into models that in turn can be used to identify key gaps in the observing infrastructure. There is much work needed before this can be fully realised, but the data infrastructure behind EMODnet is likely to be a key piece of that puzzle.

2.3 Searching for individual datasets

A portal like SOOSmap can only include those datasets that have already been aggregated and curated. However, much research data, including that from regional and process studies, is never likely to make it into an aggregated dataset. Additionally, new data types will likely be collected and published individually well before resources are found to aggregate them. It is therefore important to ensure that such datasets are also easily discoverable.

To assist with this discoverability, SOOS has a portal through NASA's Global Change Master Directory (GCMD). The GCMD hosts metadata about the majority of data collected through National Antarctic Programs, as well as extensive ocean-based datasets. The SOOS portal contains 4500 datasets and we are working with international data centres to encourage them to translate their metadata records into a format that can be included in the GCMD.

SOOS bridges the Antarctic and oceanographic research communities, which have largely coalesced around two different metadata standards. This poses particular challenges for bringing all of those metadata records into a single searchable database, such as the GCMD. So, while SOOS continues to encourage efforts towards developing metadata brokering tools to enable the GCMD portal to grow, it is also actively investigating options to develop a federated data search tool.

In federated search, a single website is used to simultaneously search multiple data catalogues that use different metadata standards. Because the metadata records stay in their originating data catalogue, issues of imperfectly translated and duplicated metadata records are avoided.

SOOS is working with other polar data communities to investigate options for developing a federated search tool for the region. We welcome discussions and collaborations with allied communities.

Acknowledgements

SOOS is a body of the Scientific Committee on Antarctic Research and the Scientific Committee on Oceanic Research. We thank the Australian Antarctic Data Centre and EMODnet Physics group for their donations of development and hosting services.

References

Meredith, M., Schofield, O., Newman, L., Urban, E., Sparrow, M. (2013). The vision for a Southern Ocean Observing System. *Current Opinion in Environmental Sustainability*, 5:3-4, 306-313.

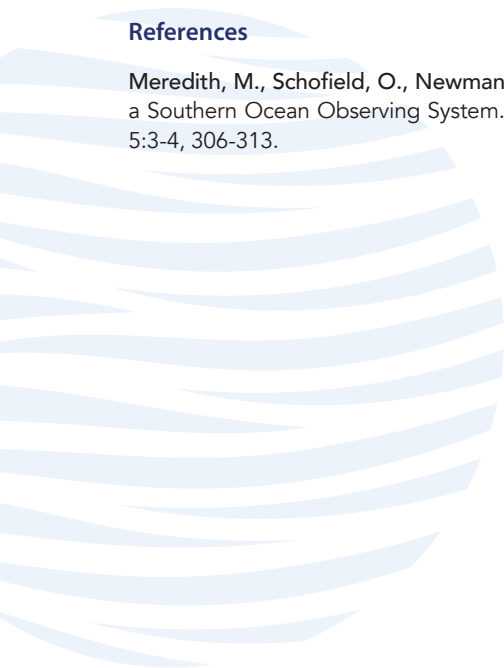

INDEX OF AUTHORS



A

Akpınar, A.	149
Alari, V.	223, 269
Alenius, P.	143
Ali, A.	201
Álvarez, D.	485
Álvarez Fanjul, E.	295, 319, 353, 379, 401
Amo-Baladrón, A.	319, 401
Aouf, L.	319, 401
Aparicio, A.	371
Aprin, L.	387
Arcilla, A.S.	295
Arena, F.	113
Arranz, L.	481
Artigas, F.	43
Assmann, S.	127
Axell, L.	261, 327
Aznar, R.	319

B

Bahamon, N.	415
Balbín, R.	371
Ballas, D.	53
Barrera, E.	319, 401
Basáñez, A.	401
Behrens, A.	223, 367
Beja, J.	495
Bekiari, M.	53
Bellerby, R.G.J.	121
Benkiran, M.	319
Bensi, M.	113
Bertino, L.	43
Beszczynska-Möller, A.	165
Bidlot, J-R.	223
Blanc, F.	415
Bobylev, L.	409
Bolzon, G.	285
Bonaduce, A.	415
Bourma, E.	53
Bowyer, P.	319
Breivik, Ø.	223, 367
Bricaud, C.	215
Bricher, P.	495
Brunetti, F.	113

Bubbi, A.	113
Buck, J.	19
Burud, A.	43

C

Cabrero, A.	481
Cailleau, S.	319, 395
Calewart, J.-B.	415
Cancouët, R.	19
Caporale, C.	173
Capuzzo, E.	189
Cardin, V.	113
Carlier, A.	43
Carrasco, A.	201, 367
Casas, B.	485
Causio, S.	173
Cerralbo, P.	379
Cesarini, C.	415
Chabot, G.	395
Chalkiopoulos, A.	53
Chamarro, I.	481
Chapron, B.	135
Charcos, M.	485
Charria, G.	149
Chataing, S.	387
Christodoulaki, S.	53
Ciliberti, S.A.	173, 209, 275
Cipollone, A.	209
Cisek, M.	165
Claustre, H.	19
Clavier, M.	251
Clementi, E.	275, 295, 335, 415
Colijn, F.	63
Collard, F.	135
Collingridge, K.	189, 447
Coppini, G.	209, 295
Cossarini, G.	285, 295
Créach, V.	183, 189, 447
Creti, S.	209
Crise, A.	285
Cruzado, A.	415
Cucco, A.	295
Cusack, C.	453

D

Dabrowski, T.	243, 319, 453
Dalphinnet, A.	319, 401
Danielson, R.	135
De Alfonso, M.	401
De La Villéon, L.P.	63
De Nucé, A.	395
de Swart, L.	97
del Rio, J.	97
Delauney, L.	43, 97
Delory, L.	97
Delrosso, D.	275, 335
Demarte, M.	173
Demchev, D.	409
Derval, C.	395
Desportes, C.	215
Devlin, M.	447
Di Cerbo, P.	285
Di Pietro, P.	275, 335
Díaz Hernández, G.	379
Diggs, S.	495
Donlon, C.	135
Donnay, E.	387
Dorgeville, E.	113
Drévilion, M.	215, 251
Drillet, Y.	215, 251
Drudi, M.	275, 335
Duarte, R.	415
Dubois, C.	215
Durand, E.	395
Dushaw, B.	105

E

Emmanouil, G.	305
Escola, R.	135
Espino, M.	379

F

Fabi, G.	415
Facq, J.V.	43
Falcini, F.	415
Falconieri, A.	173
Farcy, P.	27, 43
Federico, I.	173, 295

Feijo, A.	319
Fenu, E.	275
Fernández, J.G.	485
Ferrarin, C.	295
Feudale, L.	285
Filipot, J.-F.	415
Forster, R.M.	183, 189
Francesca, M.	209
Frangoulis, C.	53
Fратиanni, C.	173, 275, 335
Frontera, B.	485

G

Galanis, G.	305, 415
García, Sotillo, M.	379
García-Martínez, M.C.	371
García-Valdecasas, J.M.	319, 379, 401
Garreau, P.	295
Garric, G.	215, 251
Gasparin, F.	251
Gaultier, L.	135
Gehrung, M.	127
Giani, M.	113
Golmen, L.	97, 121
Gómara, S.	485
Gómez-Pujol, L.	415, 485
Gomila, M.	485
González-Nuevo, G.	481
Gorringe, P.	63, 423
Goszczko	165
Gourcuff, I.	19
Gourrion, J.C.	439
Grandi, A.	173, 275, 335
Grayek, S.	223
Greiner, E.	215, 251
Grifoll, M.	379

H

Haapala, J.	19
Hamon, M.	215
Hansen, M.	135
Harscoat, V.	27
Heinrich, V.	19
Hellouvy, Y.-H.	387

Hernández, F.	215
Heslop, E.	485
Ho-Hagemann, H.	223
Huess, V.	261
Hull, T.	189

I

Igarashi, H.	473
Iovino, D.	209
Ishikawa, Y.	473
Ishizaki, S.	473

J

Jaccard, P.	121
Jiménez, J.A.	371
Johannessen, J.A.	135

K

Käärmann, L.	149
Kaitala, S.	63
Kalampokis, A.	53
Kallos, G.	305, 415
Karlson, B.	43, 63
Kassis, D.	19, 53
Katara, I.	415
Kay, S.	311
Kazakov, E.	409
King, A.	63
King, A.L.	121
King, B.A.	19
King, R.	311
Klarić, D.	179
Klein, B.	19
Korosov, A.	135, 491
Korres, G.	19
Korres, M.	53
Köouts, T.	149, 169
Kouvarda, D.	415
Krasakopoulou, E.	193
Krauzig, N.	193
Krüger, O.	367
Kuchler, S.	113
Kvalsund, K.	97
Kyriakidou, C.	415

L

Lacava, T.	173
Lagemaa, P.	261
Lardner, R.	305
Lazure, P.	43
Lazzari, P.	285
Le Floch, S.	387
Le Galloudec, O.	215, 251
Le Traon, P.-Y.	71, 215
Lecci, R.	173, 209, 415
Ledang, A.B.	121
Legrand, S.	387
Lellouche, J.-M.	215, 251
Lemieux, B.	275
Levier, B.	319
Lips, U.	63, 143
Lisi, M.	173
Liu, Y.	327
López, I.	319
López Lara, J.	379
López-Jurado, J.L.	371
Lorente, P.	319, 401
Lorenzetti, G.	173
Lorkowski, I.	261
Luna, Y.	379
Lyons, K.	243, 453
Lyubartsev, V.	173, 415

M

Maicu, F.	173
Mamoutos, I.	243
Manfe', G.	173
Mansutti, P.	113
Manzella, G.	415, 423
March, D.	415, 485
Marinova, V.	71
Martin, M.	311
Martín Míguez, B.	415
Martínez Marco, I.	379
Marty, S.	121
Masina, S.	209
Mattia, G.	275, 335
Maze, G.	19

Mc Connell, N.	311	Parent, L.	215
McCoy, G.	243	Pärt, S.	169
Medina, R.	379	Partenay, V.	387
Melsom, A.	43, 201	Pascual, A.	319
Merchel, M.	165	Patlakas, P.	415
Mestres, M.	379	Pearlman, J.	97
Montagna, F.	209	Pérez Gómez, B.	353, 379
Montero, P.	401	Pérez González, I.	353
Mork, K.A.	19	Pérez Rubio, S.	379
Mourre, B.	295	Perivoliotis, L.	53
Moussat, E.	415	Petersen, W.	63, 127
Moya, F.	371	Petihakis, G.	27, 43, 53, 63
Murawski, J.	233	Petit de la Villéon, L.	431
Müller, M.	201	Pettas, M.	53
Muñoz, C.	485	Pfeil, B.	495
N		Piedracoba, S.	401
Nencioli, F.	135	Pinardi, N.	173, 209, 275, 335, 415
Nikolaidis, A.	305	Piollé, J.-F.	135
Nishikawa, S.	473	Pistoia, J.	275, 335
Norli, M.	121	Poncet, F.	387
Notario, F.	485	Potiris, M.	53
Novellino, A.	423, 447	Poulain, P.M.	19
Ntoumas, M.	53, 63	Pouliquen, S.	19, 27, 423, 431, 439
O		Poupon, E.	387
O'Conchubhair, D.	19	Puillat, I.	27, 43
O'Dea, E.	311	Purokoski, T.	143
O'Rourke, E.	19, 453	Q	
Obaton, D.	395	Quartly, G.	135
Obolensky, G.	19	Quimbert, E.	415
Oddo, P.	173	R	
Orsi, S.	387	Radhakrishnan, H.	305
Østerhus, S.	97	Raicich, F.	415
Otero, P.	481	Rainaud, R.	319, 401
P		Raj, R.P.	135
Padeletti, D.	275	Rak, D.	165
Padorno, E.	379	Rašić, D.	179
Pagonis, P.	53	Ravdas, M.	53, 295
Palazov, A.	71	Reffray, G.	319
Paleletti, D.	335	Reggiani, E.	121
Palermo, F.	209	Régnier, C.	215, 251
Papadopoulos, A.	53	Reizopoulou, S.	415
		Reppucci, A.	71

Reverdin, G.	439	Soraghan, C.	183
Rey, P.	319	Sørensen, K.	63, 121
Rickards, L.	423	Sorgente, R.	295
Ricker, M.	367	Sotillo, M.G.	295, 319, 353, 401
Rieke, M.	97	Sotiropoulou, M.	53
Rikka, S.	149	Staneva, J.	223, 367
Rio, M.-H.	135	Stefanizzi, L.	209
Roca, M.	135	Sterl, A.	19
Rodríguez Dapena, Á.	319, 379	Storto, A.	209, 275, 335
Roiha, P.	143	Stylianou, S.	305, 415
Rotllán, P.	485	Sutherland, G.	201
Rubio, A.	43	Sykes, P.	311
Ruiz, I.	485	Szekely, T.	149, , 439
Rújula, M.A.	485		
Ryan, A.	311		
S			
Salon, S.	285, 295	Tanaka, Y.	473
Sammartino, S.	295	Tassetti, A.N.	415
Samuelsen, A.	201, 361	Tel, E.	371, 481
Sánchez Arcilla, A.	379	Tengberg, A.	113
Santiago, R.	371	Teruzzi, A.	285
Santos Atienza, I.	379	Thierry, V.	19
Saulter, A.	311	Thijssse, P.	423
Scarcella, G.	415	Tikka, K.	143
Schaap, D.	423	Tintoré, J.	27, 415, 485
Schallier, R.	387	Toledano, C.	319, 401,
Schluter, L.	189	Tonani, M.	311
Schrum, C.	223, 367	Tragou, E.	193
Schwichtenberg, F.	261	Triantafyllou, G.	53
Sepp-Neves, A.	173	Trotta, F.	173, 209
Seppälä, J.	63	Troupin, C.	485
Serra, M.	371	Tsiaras, K.	53
She, J.	233, 261, 463	Tuomi, L.	143, 261, 269
Shutler, J.	135	Turrisi, G.	209
Siena, G.	113		
Siili, T.	269	U	
Siiriä, S.	143	Umgiesser, G.	295
Silke, J.	453	Ursella, L.	113
Simoncelli, S.	275, 415	Usk, A.	149
Skoulidakis, N.	415		
Slabakova, V.	71	V	
Sofianos, S.	305	Vähä-Piikkiö, O.	269
Solidoro, C.	285	Vahter, K.	169
		Valladeau, G.	415
		Vallespir, J.	415

Vandermeirsch, F.	149
Vargas-Yáñez, M.	371
Velanas, S.	53
Vélez, P.	19
Verri, G.	295
Vervatis, V.	305
Vilibić, I.	295
Villasuso, J.	319
Viloria, A.	481
Vines, A.	491
Volkov, V.	409
Voynova, Y.G.	127

W

Wakamatsu, T.	473
Walczowski, W.	19, 165
Wehde, H.	63
Wergeland Hansen, M.	491
Wieczorek, P.	165
Wiesse, A.	367
Williams, T.D.	201
Rodríguez, A.	319

X

Xie, J.	43, 201
---------	---------

Y

Youdjou, N.	387
Yumruktepe, V.Ç.	361

Z

Zacharioudaki, A.	53
Zaggia, L.	173
Zavatarelli, M.	173
Zervakis, V.	193
Zielinski, O.	97
Zodiatis, O.	295, 305, 415

LIST OF PARTICIPANTS



FIRST NAME	SURNAME	ORGANIZATION	COUNTRY
Anil	Akpinar	LOPS/IFREMER	France
Pekka	Alenius	Finnish Meteorological Institute	Finland
Lars	Axell	SMHI	Sweden
Ali	Aydogdu	NERSC	Norway
Pierre	Bahurel	Mercator Ocean	France
Laurent	Bertino	Nansen Center	Norway
Lars	Boehme	Scottish Oceans Institute	United Kingdom
Pip	Bricher	Southern Ocean Observing System	Australia
Holger	Brix	Institute for Coastal Research, Helmholtz-Zentrum Geesthacht	Germany
Bernd	Bruegge	BSH	Germany
Erik	Buch	EuroGOOS AISBL	
Vanessa	Cardin	OGS	Italy
Thierry	Carval	Ifremer	France
Guillaume	Charria	LOPS/IFREMER	France
Emanuela	Clementi	Istituto Nazionale di Geofisica e Vulcanologia, INGV	Italy
Kate	Collingridge	Cefas	UK
Veronique	Creach	Cefas	UK
L. Antonio	Cuevas	University of Concepcion	Chile
Tomasz	Dabrowski	Marine Institute	Ireland
Vlado	Dadic	Institute of oceanography and fisheries	Croatia
Dorothy	Dankel	UiB	Norway
Christine	DAVID- BEAUSIRE	IUEM/LOPS	France
JOAQUIN	DE RIO	Universitat Politècnica de Catalunya, UPC	Spain
Laurent	Delauney	IFREMER	France
Stephan	Dick	Bundesamt für Seeschifffahrt und Hydrographie (BSH)	Germany
Karen	Donaldson	Department of Fisheries and Oceans	Canada
Dominique	Durand	COVARTEC AS / Uni Research	Norway
Edmée	Durand	Mercator Ocean	France
Brian	Dushaw	NERSC	Norway
Ghada	El Serafy	Stichting Deltares	Netherlands

FIRST NAME	SURNAME	ORGANIZATION	COUNTRY
Dina	Eparkhina	EuroGOOS AISBL	
Patrick	Farcy	IFREMER	France
Ivan	Federico	EuroMediterranean Center on Climate Change (CMCC)	Italy
Vicente	Fernández	EuroGOOS AISBL	
Albert	Fischer	IOC/UNESCO	
Constantin	Frangoulis	HCMR	Greece
Marcos	Garcia Sotillo	Puertos del Estado	España
MCarmen	García-Martínez	Instituto Español de Oceanografía	Spain
Gilles	Garric	Mercator Ocean	France
Paul	Gaughan	Irish Marine Institute	Ireland
Patrick	Gorringe	EuroGOOS AISBL	
Claire	Gourcuff	Euro-Argo ERIC	
Morten Wergeland	Hansen	NERSC	Norway
Peter	Haugan	IOC/UNESCO	
Gaute	Hope	Nansen Environmental and Remote Sensing Center	Norway
Jonathan	Igene	National Centre for Urban Research and Development	Nigeria
Puillat	Ingrid	Ifremer	France
Johnny A.	Johannessen	Nansen Environmental and Remote Sensing Center	Norway
Johannes	Karstensen	GEOMAR Helmholtz Centre for Ocean Research Kiel	Germany
Eduard	Kazakov	Nansen International Environmental and Remote Sensing Center	Russia
Robert	King	UK Met Office	United Kingdom
Kai	Sørensen	Norwegian Institute for Water Research (NIVA)	Norway
Dijana	Klaric	Meteorological and hydrological Service of Croatia	Croatia
Anton	Korosov	NERSC	Norway
Tarmo	Kõuts	Marine Systems Institute, Tallinn University of Technology	Estonia
Naomi	Krauzig	University of the Aegean	Greece

FIRST NAME	SURNAME	ORGANIZATION	COUNTRY
Kate	Larkin	European Marine Board	Belgium
Sébastien	Legrand	RBINS / OD Nature	Belgium
Jean-Michel	Lellouche	Mercator Ocean	France
Vidar	Lien	Institute of Marine Research	Norway
Martina	Loebl	Alfred-Wegener-Institute for Polar and Marine Research	Germany
Pablo	Lorente	Puertos del Estado	Spain
Julien	Mader	AZTI	Spain
Ioannis	Mamoutos	Marine Institute	Ireland
Giuseppe	Manzella	ETT SpA	Italy
Niall	McConnell	Met Office	United Kingdom
Sinead	McGlynn	Parameter Space Ltd	Ireland
Nevio	Medeot	Ist. Naz. Oceanografia e di Geofisica Sperimentale - OGS	Italy
Cristian	Muñoz Mas	SOCIB	Spain
Rajesh	Nair	Ist. Naz. di Oceanografia e di Geofisica Sperimentale - OGS	Italy
Glenn	Nolan	EuroGOOS AISBL	
Antonio	Novellino	ETT	Italy
Roshin	P. Raj	NERSC	Norway
Atanas	Palazov	Institute of Oceanology, Bulgarian Academy of Sciences	Bulgaria
Irene	Pérez González	Puertos del Estado	Spain
Wilhelm	Petersen	Helmholtz-Zentrum Geesthacht, Institute of Coastal Research	Germany
George	Petihakis	HCMR	Greece
Benjamin	Pfeil	Bjerknes Climate Data Centre University of Bergen	Norway
Nadia	Pinardi	University of Bologna	Italy
Jenny	Pistoia	INGV	Italy
Sylvie	Pouliquen	Ifremer	France
Denis	Rasic	Croatian Meteorological and Hydrological Service	Croatia
Marit	Reigstad	UiT	Norway

FIRST NAME	SURNAME	ORGANIZATION	COUNTRY
Antonio	Reppucci	Mercator Ocean	France
Alberto	Ribotti	CNR	Italy
Brice	Robert	CLS	France
Agnès	Robin	European Commission	
Manuel	Ruiz-Villarreal	Instituto Español de Oceanografía	Spain
Hanne	Sagen	Nansen Environmental and Remote Sensing Center	Norway
Helge	Sagen	Institute of Marine Research	Norway
Stefano	Salon	OGS	Italy
Stein	Sandven	Nansen Environmental and Remote Sensing Center	Norway
Andreas	Schiller	CSIRO	Australia
Jun	She	Danish Meteorological Institute	Denmark
Roberto	Sorgente	IAMC-CNR	Italia
Emil	Stanev	HZG	Germany
Joanna	Staneva	Institute for Coastal Research, HZG	Germany
Francis	Strobbe	RBINS - Belgian Marine Data Centre	Belgium
Graig	Sutherland	MET Norway	Norway
Sebastian	Swart	University of Gothenburg	Sweden
Elena	Tel	Instituto Espanol de Oceanografia	Spain
Marina	Tonani	Met Office	UK
Francesco	Trotta	University of Bologna	Italy
Laura	Tuomi	Finnish Meteorological Institute	Finland
Victor	Turpin	CNRS/LOCEAN	France
Georg	Umgiesser	ISMAR-CNR	Italy
Tsuyoshi	Wakamatsu	Nansen Environmental and Remote Sensing Center	Norway
Waldemar	Walczowski	Institute of Oceanology Polish Academy of Sciences	Poland
Henning	Wehde	IMR	Norway
Marco	Weydert	European Commission	
Jiping	Xie	NERSC	Norway
Caglar	Yumruktepe	NERSC	Norway
Annette	Zijderveld	Deltas	Netherlands



EuroGOOS Member Organizations 2018



BUNDESAMT FÜR SEESCHIFFFAHRT UND HYDROGRAPHIE



DMI Danish Meteorological Institute





EuroGOOS AISBL

231 Avenue Louise, 1050 Brussels, Belgium

Tel: +32 2 238 37 90

Email: eurogoos@eurogoos.eu

www.twitter.com/EuroGOOS

www.eurogoos.eu

EUROGOOS

EUROPEAN GLOBAL OCEAN OBSERVING SYSTEM

EuroGOOS identifies priorities, enhances cooperation and promotes the benefits of operational oceanography to ensure sustained observations are made in Europe's seas underpinning a suite of fit-for-purpose products and services for marine and maritime end-users. EuroGOOS is a pan-European network operating within the Global Ocean Observing System of the Intergovernmental Oceanographic Commission of UNESCO (IOC GOOS).

Working hand in hand with partners in the European ocean research and observation community, EuroGOOS is promoting the integration of scientific knowledge and innovation for different users spanning science, policy, industry and society. The EuroGOOS Regional Operational Oceanographic Systems deliver analysis and forecasts of Europe's regional seas and feed quality-assured data to pan-European data portals (e.g. Copernicus Marine Service and EMODNet). EuroGOOS working groups and networks of marine observing platforms (Task Teams) enhance synergy and deliver strategies, priorities and standards, towards an integrated European Ocean Observing System (EOOS).



EuroGOOS
European Global Ocean
Observing System

www.eurogoos.eu